

Jansen-Economy 60 E30/EW30/E60/EW60

Brandschutz-Türen und -Verglasungen aus Stahl

Jansen-Economy 60 E30/EW30/E60/EW60

Portes et cloisons protection incendie en acier

Jansen-Economy 60 E30/EW30/E60/EW60

Fire resistant doors and screens in steel

Systemübersicht

Merkmale
Zulassungen
Systemausführungen
Typenübersicht

Sommaire du système

Caractéristiques
Homologations
Exécutions de système
Sommaire des types

Summary of system

Characteristics
Authorisations
System versions
Summary of types

2

Profilsortiment

Assortiment de profilé

Range of profiles

12

Beispiele

Schnittpunkte
Konstruktionsdetails
Anschlüsse am Bau

Exemples

Coupes de détails
Détails de construction
Raccords au mur

Examples

Section details
Construction details
Attachment to structure

16

Leistungseigenschaften

Caractéristiques de performance

Performance characteristics

33

Alle Ausführungen dieser Dokumentation haben wir sorgfältig und nach bestem Wissen zusammengestellt. Wir können aber keine Verantwortung für die Benutzung der vermittelten Vorschläge und Daten übernehmen. Wir behalten uns technische Änderungen ohne Vorankündigung vor.
Aktuelle Version auf www.jansen.com

Nous avons apporté le plus grand soin à l'élaboration de cette documentation. Cependant, nous déclinons toute responsabilité pour l'utilisation faite de nos propositions et de nos données.
Nous nous réservons le droit de procéder à des modifications techniques sans préavis.
Version actuelle sur www.jansen.com

All the information contained in this documentation is given to the best of our knowledge and ability. However, we decline all responsibility for the use made of these suggestions and data.
We reserve the right to effect technical modifications without prior warning.
Current version available at www.jansen.com







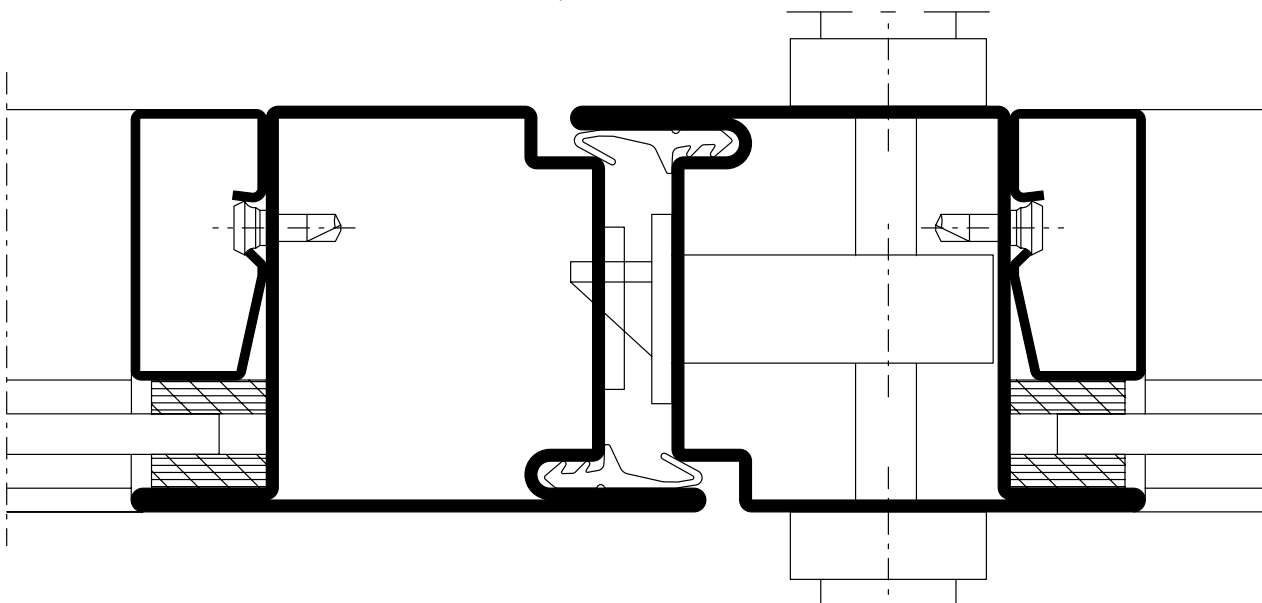

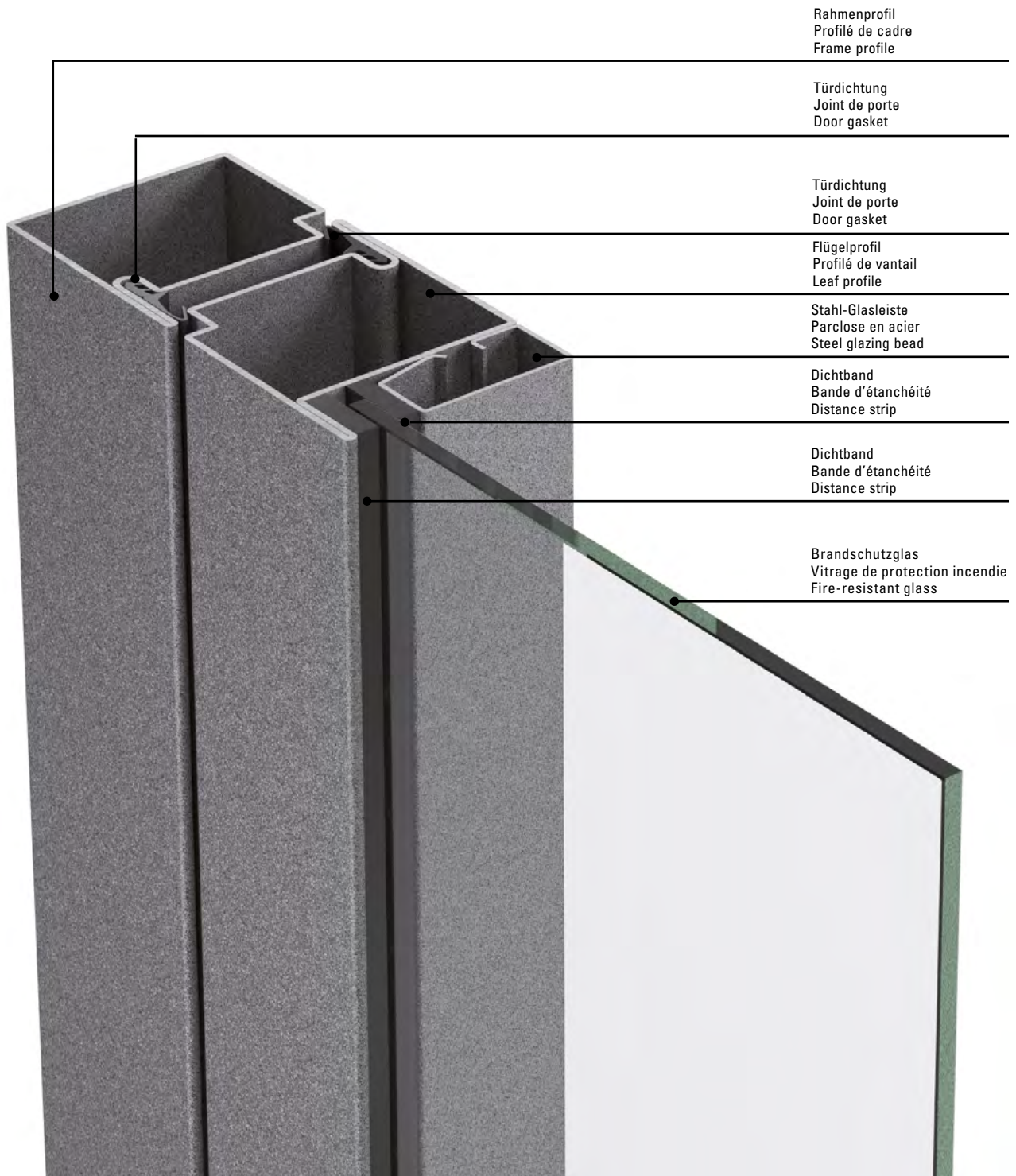
Merkmale
Caractéristiques
Characteristics

Jansen-Economy 60 E30
Jansen-Economy 60 E30
Jansen-Economy 60 E30

- Stahlsystem für Türen und Festverglasungen
 - Bautiefe 60 mm, innen und aussen flächenbündig
 - Schmale Ansichtsbreiten: Rahmen und Flügel ab 105 mm Stulppartie 150 mm
 - Ein- und zweiflüglige Türen, nach innen und aussen öffnend, mit oder ohne Seitenteile und Oberlichter sowie Trennwände
 - Türflügel bis 1750 x 3750 mm (BxH), landesspezifische Zulassung beachten
 - Füllelementstärke von 5 bis 36 mm, Glaseinbau mittels Trocken- oder Nassverglasung
 - Systemprüfungen nach Produktnorm EN 16034
 - Stahlprofile blank oder bandverzinkt
 - Grosses Sortiment an systemgeprüften Türbeschlägen
 - Barrierefreie Schwellenausbildungen
 - Geeignet für Pulver- und Nasslackbeschichtungen
 - Erscheinungsbild deckungsgleich mit anderen Jansen Brandschutzsystemen Jansen-Economy 50, Janisol 2 und Janisol C4
- Système en acier pour portes et vitrages fixes
 - Profondeur de montage 60 mm, montage à fleur à l'intérieur et à l'extérieur
 - Fines largeurs de face: Cadre et vantaux à partir de 105 mm Partie tête 150 mm
 - Portes à un et deux vantaux, ouverture vers l'intérieur et vers l'extérieur, combinables avec parties latérales, impostes et vitrage fixe
 - Vantaux de porte jusqu'à 1750 x 3750 mm (LaxH), il convient de respecter les prescriptions et règlements des divers pays concernés
 - Élément de remplissage de 5 à 36 mm d'épaisseur, Montage du vitrage à sec ou à silicone
 - Contrôles des systèmes selon la norme produit EN 16034
 - Profilés en acier brut ou galvanisé en continu
 - Grand assortiment de ferrures de porte homologuées
 - Formes de seuil sans barrière
 - Convient aux revêtements par poudre ou peinture liquide
 - Apparence egale comme les autres systèmes coupe-feu de Jansen (Jansen-Economy 50, Janisol 2 et Janisol C4)
- Steel system for doors and fixed glazing
 - 60 mm basic depth, flush-fitted on the inside and outside
 - Narrow face widths: Frame and leaf from 105 mm Meeting stile assembly 150 mm
 - Single and double-leaf doors, inward and outward-opening, can be combined with side-lights, toplight or fixed glazing
 - Door leaf up to 1750 x 3750 mm (WxH), the regulations and bye-laws in force in the particular country must be respected
 - Infill unit thickness of 5 to 36 mm, Glazing installed by means of dry or wet glazing
 - System tests in accordance with EN 16034
 - Raw finish or strip galvanised steel profiles
 - Large range of system-tested door fittings
 - Easy-access thresholds
 - Suitable for powder and wet paint coating
 - Same appearance as the other Jansen fire-resistant systems Jansen-Economy 50, Janisol 2 and Janisol C4





| Norm | Eigenschaft Caractéristique Characteristic | Klassifizierung/Wert Classification / Valeur Classification / Value | | | | | | | | | |
|---|--|---|---|------------|-------------|-------------|-------------|--------------|--------------|--------------|----------------|
|  EN ISO 10077-2 | Wärmedurchgangskoeffizient U_f (W/(m²·K)) Transmission thermique U_f (W/(m²·K)) Thermal production U_f (W/(m²·K)) | npd | ab 5.65 W/m ² K à partir de 5.65 W/m ² K from 5.65 W/m ² K | | | | | | | | |
|  EN 1627 | Einbruchhemmung Anti-effraction Burglar resistance | npd | 1 | 2 | 3 | 4 | 5 | 6 | | | |
|  EN 1522 | Durchschusshemmung Résistance aux balles Bullet proofing | npd | FB1 | FB2 | FB3 | FB4 | FB5 | FB6 | FB7 | FSG | |
|  EN 1191 EN 1603 | Dauerfunksprüfung Durabilité mécanique Mechanical durability | | D | 1 5'000 | 2 10'000 | 3 20'000 | 4 50'000 | 5 100'000 | 6 200'000 | 7 500'000 | 8 1'000'000 |
|  EN 12217 | Bedienkräfte Forces de manœuvre Operating forces | npd | 0 | | | 1 | | 2 | | | |
|  EN 179 EN 1125 | Fähigkeit zur Freigabe Capacité au déclenchement Ability to release | | Anforderung erfüllt Exigence remplie Requirement fulfilled | | | | | | | | |
|  EN 1634-1 EN 13501-2 | Brandschutz Résistance aux feu Fire resistance | | E30 / EW30 / E60 / EW60 | | | | | | | | |
|  EN 16034 EN 13501-2 | Selbstschliessung Fermeture automatique Self-closing | | C | | | | | | | | |
|  EN 16034 | Dauerhaftigkeit der Selbstschliessung gegenüber Alterung (Korrosion) Endurance de la fermeture automatique contre le vieillissement (corrosion) Durability of self-closing against ageing (corrosion) | | erzielt atteinte achieved | | | | | | | | |



Fluchttürsysteme

- Fluchttürsysteme geeignet für Notausgänge und Paniktüren
- Fluchttürnorm EN 179 für Notausgangsverschlüsse erfüllt
- Fluchttürnorm EN 1125 für Panikverschlüsse erfüllt

Systèmes de porte de secours

- Systèmes de porte de secours pour issues de secours et portes panique
- Norme relative aux portes de secours EN 179, remplie pour les fermetures d'issue de secours
- Norme relative aux portes de secours EN 1125, remplie pour les fermetures panique

Emergency exit systems

- Emergency exit systems suitable for emergency exits and panic doors
- Emergency exit standard EN 179 for emergency exit devices fulfilled
- Emergency exit standard EN 1125 for panic exit devices fulfilled

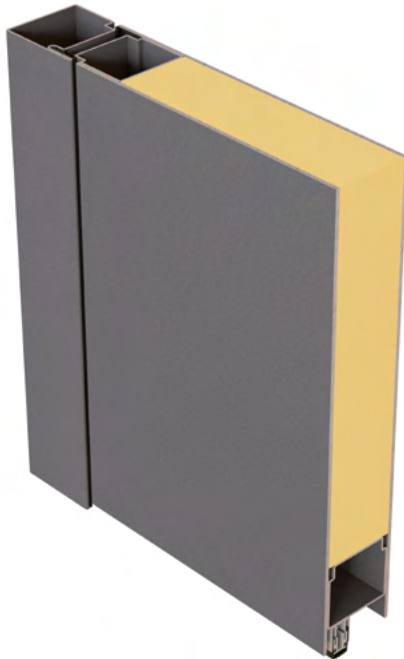

Verblechte Jansen-Economy 60 E30 Türen

- Für ein- und zweiflügelige Brandschutztüren mit oder ohne Seitenteile resp. Oberlichter
- Flächenbündig verblechte Türen
- Bleche können an den Rahmen geschweisst oder geklebt werden
- Mit oder ohne Glasausschnitte möglich

Portes tôlées Jansen-Economy 60 E30

- Pour des portes coupe-feu à un/deux vantaux avec ou sans pièces latérales ou impostes
- Portes tôlées à fleur
- Les tôles peuvent être soudées ou collées sur le cadre
- Possibles avec ou sans panneaux de verre

Jansen Economy 60 E30 sheet metal doors

- For single and double-leaf fire doors with or without sidelights or toplights
- Flush-fitted sheet metal doors
- Sheet metal can be welded or bonded to the frame
- Possible with or without glass vision panels

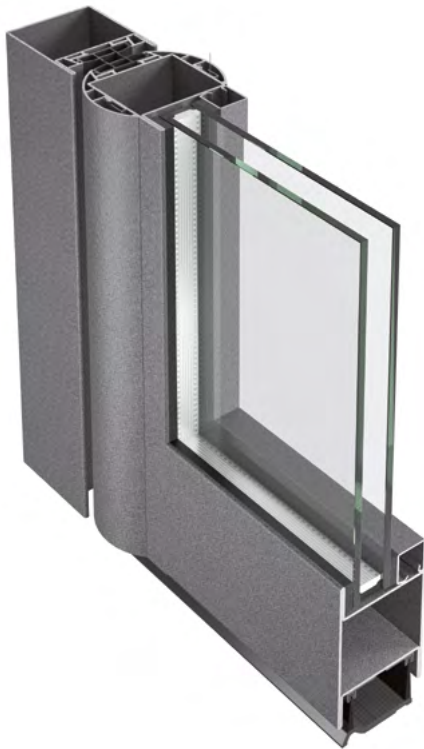

Jansen-Economy 60 E30 / EW30 / E60 / EW60
Fingerschutztüre

- Keine Quetsch- und Scherstellen nach DIN 18650
- Wartungsarme Bandlager unten und oben
- Geeignet für Gebäude mit starkem Publikumsverkehr
- Geprüft nach EN 14351-1

Portes anti-pince-doigts

Jansen-Economy 60 E30 / EW30 / E60 / EW60

- Absence de zones d'écrasement et de cisaillement selon DIN 18650
- Paliers de paumelle inférieur et supérieur exigeant peu de maintenance
- Adapté à des bâtiments publics fortement fréquentés
- Contrôlé selon la norme EN 14351-1

Jansen Economy 60 E30 / EW30 / E60 / EW60
anti-finger-trap doors

- No crushing and shearing points as per DIN 18650
- Low-maintenance hinge bush at top and bottom
- Suitable for buildings subject to frequent use by the public
- Tested in accordance with EN 14351-1

Jansen Docu Center

Die Plattform zum effizienten Arbeiten mit Jansen Dokumentationen. Im Jansen Docu Center stehen alle Produktinformationen jederzeit digital in der aktuellsten Version zur Verfügung: von Architekten-Informationen über Bestell- und Fertigungskatalogen bis hin zu Anleitungen und Prospekten sowie Videos.

Die Inhalte können einfach und schnell aufgerufen werden. Ein für den Anwender komfortables papierloses Arbeiten, das zahlreiche Vorteile bietet.

Jansen Docu Center

La plate-forme pour travailler efficacement avec les documentations Jansen. Le Jansen Docu Center met à votre disposition les informations sur les produits, en format numérique et dans une version actualisée: des catalogues de commande et de fabrication aux instructions et prospectus, en passant par les informations destinées aux architectes et vidéos.

Les contenus sont facilement et rapidement accessibles. Une manière de travailler confortable et offrant de nombreux avantages.

Jansen Docu Center

The platform for working efficiently with Jansen documentation. The latest version of all the product information is available digitally at any time in the Jansen Docu Center – from order and fabrication manuals to architect information, instructions and brochures and videos.

The content can be retrieved quickly and easily. The user can work conveniently without paper, which has numerous benefits.

Download CAD Daten

DXF

DWG

Sie können die Zeichnungen in den Formaten DXF und/oder DWG herunterladen. Klicken Sie auf das entsprechende Icon und der Download erfolgt.

Die Hinweise «Artikelbibliothek/Türbeschläge/Fensterbeschläge» bedeuten, dass Sie mit einem Klick die gesamte Artikelbibliothek des entsprechenden Systems herunterladen (Profile, Beschläge, Glasleisten, Zubehör etc.).

Info und Beratung

Gerne beraten wir Sie persönlich und stehen Ihnen bei Fragen zur Verfügung. Bitte schreiben Sie uns Ihre Anliegen an: info@jansen.com

Télécharger fichiers DAO

DXF

DWG

Vous pouvez télécharger les dessins aux formats DXF et/ou DWG. Cliquez sur l'icône correspondante et le téléchargement s'effectuera.

Les indications «Bibliothèque des articles/Ferures de porte/Ferrures de fenêtres» signifie que vous téléchargez la totalité de la bibliothèque des articles du système donné (profilés, ferrures, parclozes, accessoires etc.).

Info et conseils

Nous vous conseillerons volontiers individuellement et sommes à votre disposition si vous avez des questions à poser. Veuillez nous envoyer votre requête à: info@jansen.com

Download CAD files

DXF

DWG

You can download the drawings in DXF and/or DWG format. Click on the relevant icon to begin the download.

The items «Article library/Door fittings/Window fittings» means that you download the entire article library for the corresponding system with one click (profiles, fittings, glazing beads, accessories etc.).

Information and advice

We would be delighted to provide you with advice in person and are available to answer any questions you may have. Please write to us with your queries at: info@jansen.com

Ausgeführte Objekte
Objets réalisés
Completed projects

Jansen-Economy 60 E30
Jansen-Economy 60 E30
Jansen-Economy 60 E30



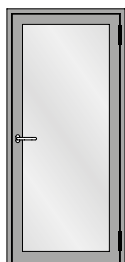

Einflügelige Türe
 Porte à un vantail
 Single leaf door

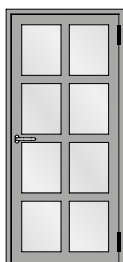

Einflügelige Türe mit Riegel
 Porte à un vantail avec traverse
 Single leaf door with transom

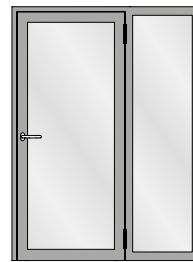

Einflügelige Türe mit festem Seitenteil
 Porte à un vantail avec partie latérale fixe
 Single leaf door with fixed side light

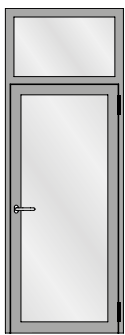

Einflügelige Türe mit festem Oberlicht
 Porte à un vantail avec imposte fixe
 Single leaf door with fixed top light

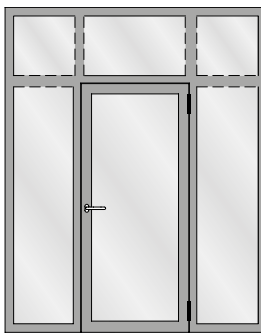

Einflügelige Türe mit zwei festen Seitenteilen
 und festem Oberlicht
 Porte à un vantail avec deux parties latérale fixe
 et imposte fixe
 Single leaf door with two fixed side light and
 fixed top light

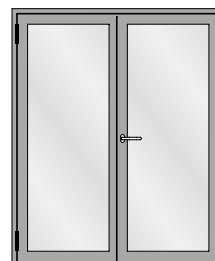

Zweiflügelige Türe
 Porte à deux vantaux
 Double leaf door



Zweiflügelige Türe mit zwei festen Seitenteilen
 Porte à deux vantaux avec deux parties
 latérales fixes
 Double leaf door with two fixed side lights

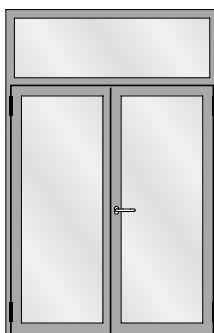

Zweiflügelige Türe mit festem Oberlicht
 Porte à deux vantaux avec imposte fixe
 Double leaf door with fixed top light

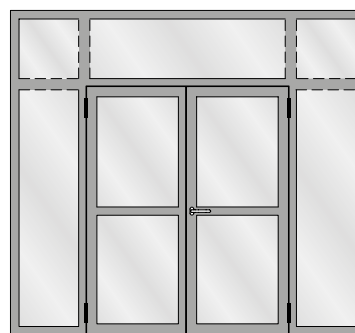

Zweiflügelige Türe mit zwei festen Seitenteilen
 und festen Oberlichtern
 Porte à deux vantaux avec deux parties latérales
 fixes et impostes fixes
 Double leaf door with two fixed side lights and
 fixed top lights

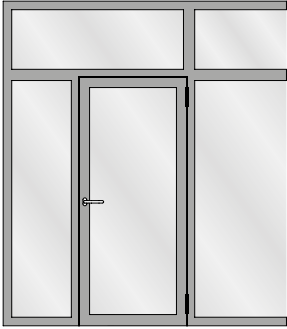

Festverglasung mit einflügeliger Türe
Vitrage fixe avec porte à un vantail
Fixed glazing with single leaf door

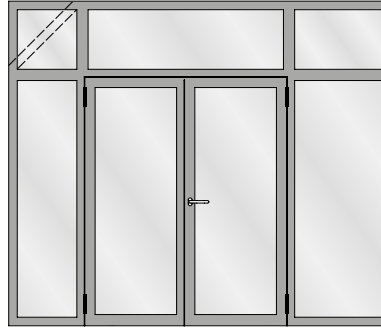

Festverglasung mit zweiflügeliger Türe
Vitrage fixe avec porte à deux vantaux
Fixed glazing with double leaf door

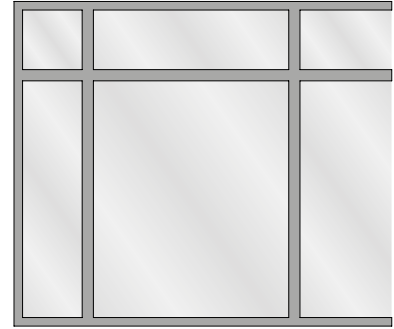

Festverglasung
Vitrage fixe
Fixed glazing

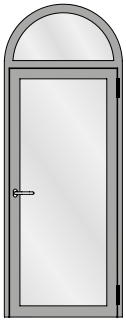

Einflügelige Türe mit Rundbogen-Oberlicht
Porte à un vantail avec imposte demi-ronde
Single leaf door with round arched top light

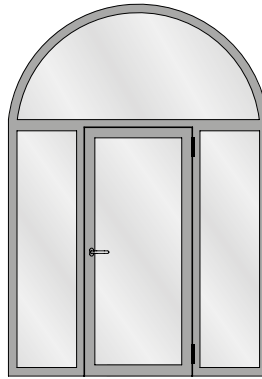

Einflügelige Türe mit zwei festen Seitenteilen
und Rundbogen-Oberlicht
Porte à un vantail avec deux parties latérales
fixes et imposte demi-ronde
Single leaf door with two fixed side lights and
round arched top light

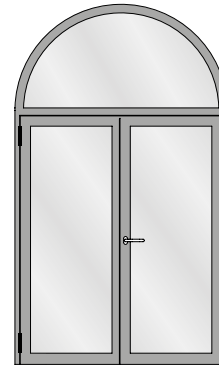

Zweiflügelige Türe mit Rundbogen-Oberlicht
Porte à deux vantaux avec imposte demi-ronde
Double leaf door with round arched top light

**Für Festverglasungen gelten
nationale Zulassungen.**

**Les homologations nationales
s'appliquent aux vitrages fixes.**

**National approvals apply to fixed
glazing.**

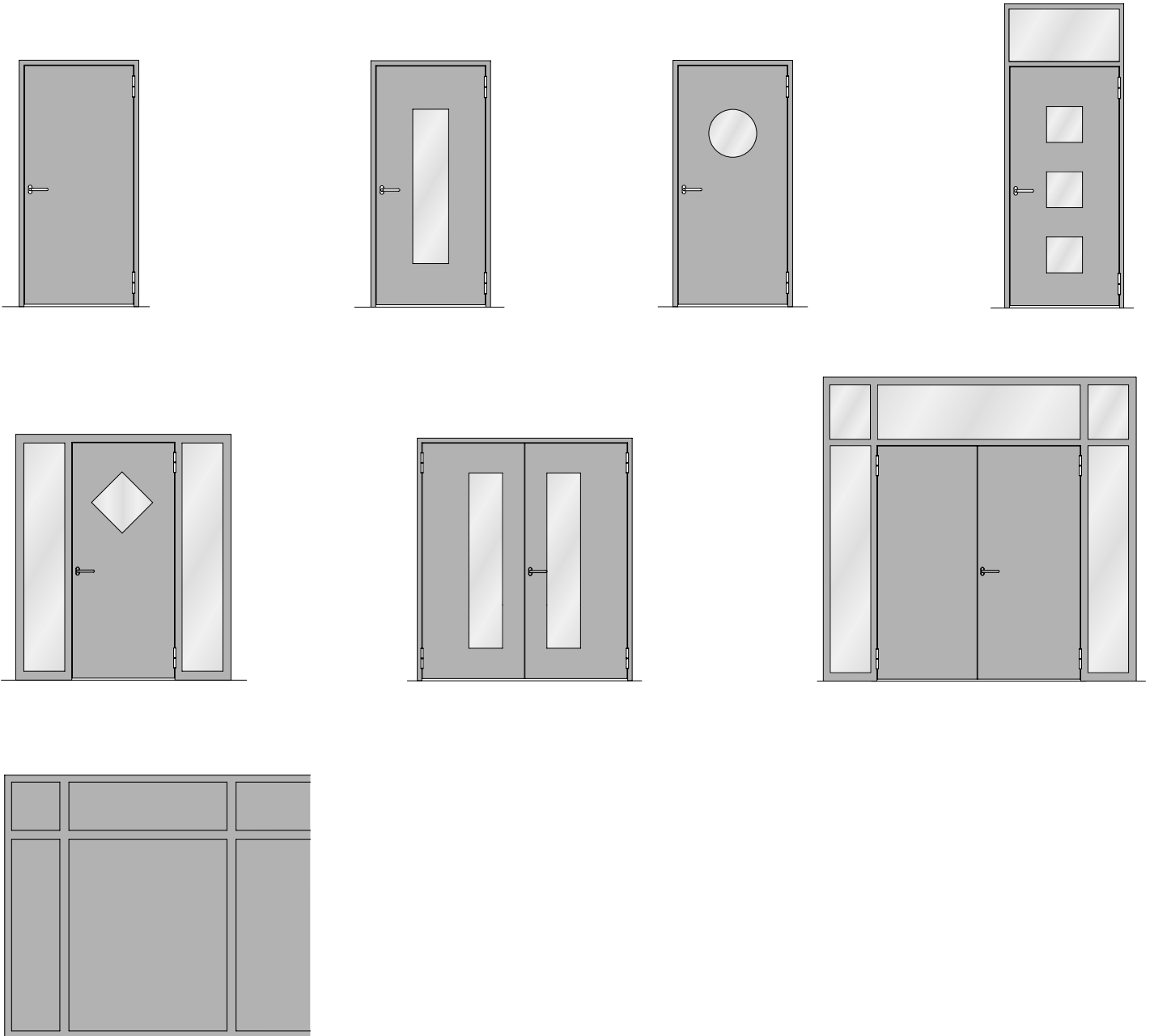

Für Festverglasungen gelten nationale Zulassungen.

Les homologations nationales s'appliquent aux vitrages fixes.

National approvals apply to fixed glazing.

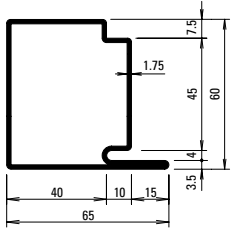

30.019
30.019 Z

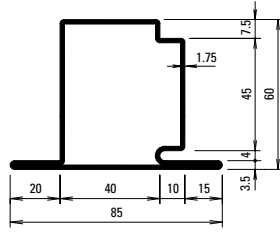

30.119
30.119 Z

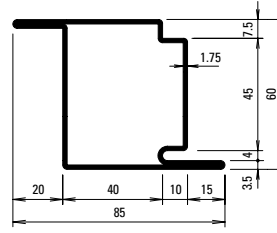

30.419
30.419 Z

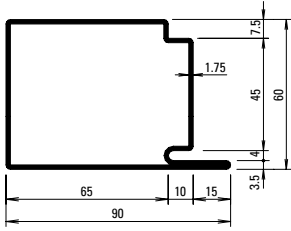

30.017
30.017 Z

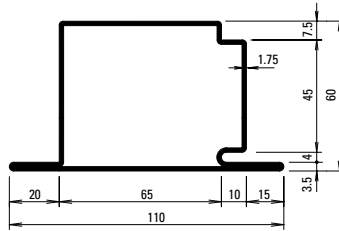

30.117
30.117 Z

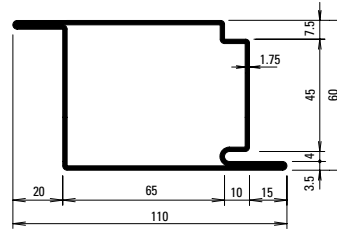

30.415

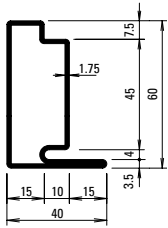

30.018
30.018 Z

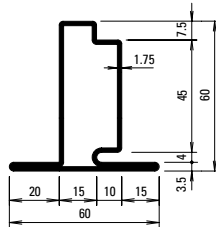

30.118
30.118 Z

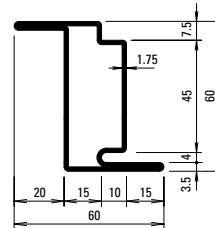

30.418
30.418 Z

Oberfläche/Werkstoff

Artikel-Nr.

ohne Zusatz = blank

mit Z = bandverzinkter Stahl

Surface/Matériau

No. d'article

sans supplément = brut

avec Z = bande d'acier zinguée

Surface/Material

Part no.

without addition = bright

with Z = strip galvanised steel

| Profil-Nr. | G kg/m | F cm ² | I _x cm ⁴ | W _x cm ³ | I _y cm ⁴ | W _y cm ³ | U m ² /m |
|---------------|-----------|----------------------|-----------------------------------|-----------------------------------|-----------------------------------|-----------------------------------|------------------------|
| 30.017 | 4,200 | 5,36 | 31,32 | 9,09 | 48,57 | 10,35 | 0,312 |
| 30.018 | 2,830 | 3,61 | 15,95 | 4,35 | 4,77 | 1,93 | 0,212 |
| 30.019 | 3,520 | 4,48 | 23,69 | 6,70 | 19,75 | 5,55 | 0,262 |
| 30.117 | 4,750 | 6,04 | 34,75 | 9,35 | 65,74 | 11,51 | 0,350 |
| 30.118 | 3,370 | 4,29 | 18,64 | 4,65 | 8,26 | 2,75 | 0,250 |
| 30.119 | 4,050 | 5,16 | 26,80 | 6,99 | 29,12 | 6,58 | 0,300 |

| Profil-Nr. | G kg/m | F cm ² | I _x cm ⁴ | W _x cm ³ | I _y cm ⁴ | W _y cm ³ | U m ² /m |
|---------------|-----------|----------------------|-----------------------------------|-----------------------------------|-----------------------------------|-----------------------------------|------------------------|
| 30.415 | 4,750 | 6,04 | 37,79 | 12,28 | 65,74 | 11,51 | 0,350 |
| 30.418 | 3,370 | 4,29 | 22,92 | 7,37 | 8,62 | 2,75 | 0,250 |
| 30.419 | 4,050 | 5,16 | 30,36 | 9,82 | 29,12 | 6,58 | 0,300 |

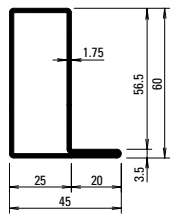

01.634
01.634 Z

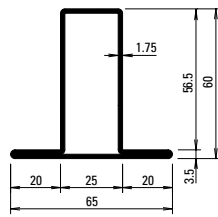

02.634
02.634 Z

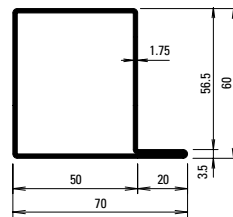

01.684
01.684 Z

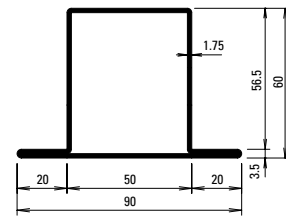

02.684
02.684 Z

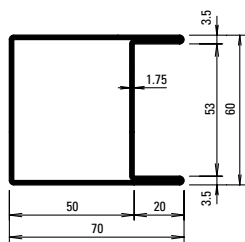

04.637
04.637 Z

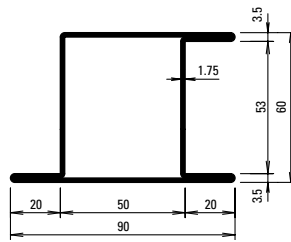

05.637
05.637 Z

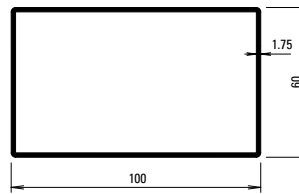

400.051
400.051 Z

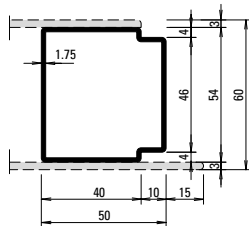

81.010
81.010 Z

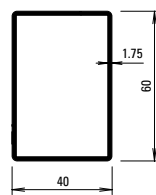

400.052
400.052 Z

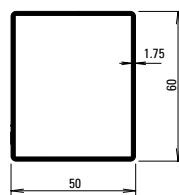

400.054
400.054 Z



400.055
400.055 Z

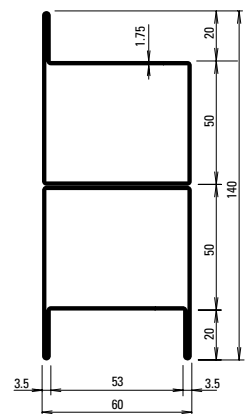

05.001

| Profil-Nr. | G kg/m | F cm ² | I _x cm ⁴ | W _x cm ³ | I _y cm ⁴ | W _y cm ³ | U m ² /m |
|----------------|-----------|----------------------|-----------------------------------|-----------------------------------|-----------------------------------|-----------------------------------|------------------------|
| 01.634 | 2,730 | 3,48 | 16,71 | 4,71 | 6,04 | 2,15 | 0,204 |
| 02.634 | 3,270 | 4,17 | 19,66 | 5,01 | 10,34 | 3,18 | 0,243 |
| 01.684 | 3,430 | 4,37 | 24,34 | 7,07 | 22,12 | 5,59 | 0,255 |
| 02.684 | 3,960 | 5,05 | 27,70 | 7,36 | 31,93 | 7,09 | 0,294 |
| 04.637 | 3,960 | 5,05 | 30,62 | 10,2 | 27,45 | 7,71 | 0,294 |
| 05.637 | 4,500 | 5,72 | 35,42 | 10,6 | 39,45 | 8,02 | 0,333 |
| 81.010 | 2,700 | 3,43 | 14,53 | 5,38 | 13,05 | 5,10 | 0,202 |
| 400.051 | 4,300 | 5,44 | 76,01 | 15,2 | 34,64 | 11,55 | 0,316 |
| 400.052 | 2,630 | 3,34 | 8,98 | 4,49 | 16,86 | 5,62 | 0,197 |
| 400.054 | 2,900 | 3,69 | 14,97 | 5,98 | 19,83 | 6,61 | 0,217 |
| 400.055 | 2,210 | 2,82 | 3,08 | 2,47 | 12,41 | 4,13 | 0,167 |

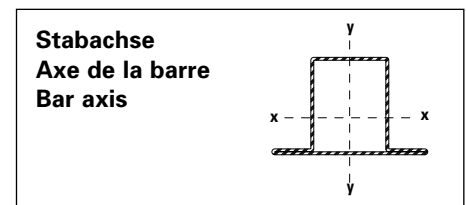

Artikelbibliothek
 Bibliothèque des articles
 Article library

DXF **DWG**

Bogentüren
Portes cintrées
Arched doors

Jansen-Economy 60 E30
 Jansen-Economy 60 E30
 Jansen-Economy 60 E30

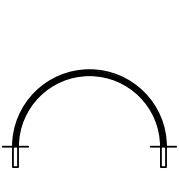
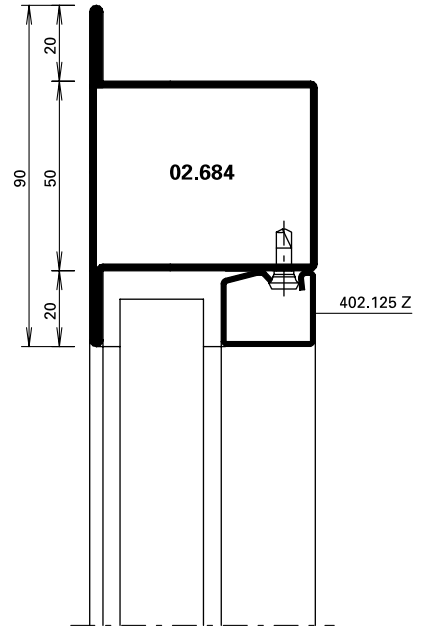
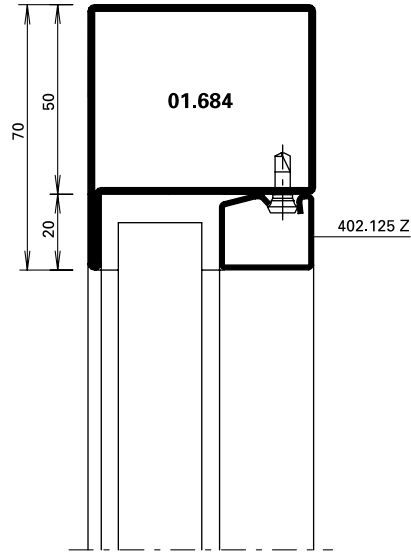
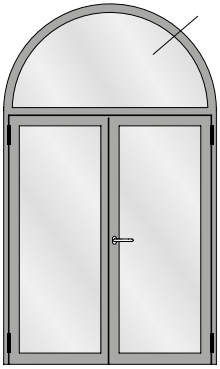

Halbrundbogen
 Arc semi-circulaire
 Semi-circular arch

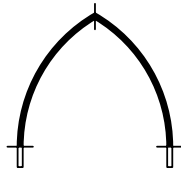

Spitzbogen
 Arc en ogive
 Gothic arch



Stichbogen
 Arc bombé
 Segmented arch



Korbbogen
 Anse de panier
 Oval arch

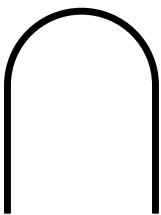

Halbrundbogen mit Schenkel
 Arc surhaussé prolongée
 Semi-circular arch with side extension

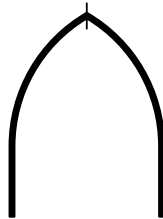

Spitzbogen mit Schenkel
 Arc en ogive prolongée
 Gothic arch with side extension

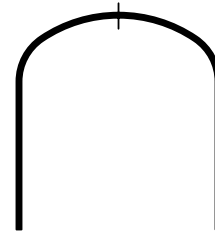



Korbbogen mit Schenkel
 Anse de panier prolongée
 Oval arch with side extension

Bogentüren
Portes cintrées
Arched doors

Jansen-Economy 60 E30
 Jansen-Economy 60 E30
 Jansen-Economy 60 E30

| Profil Profilé Profile | Min. Radius Rayon min. Min. radius R |
|------------------------------|---|
|------------------------------|---|

| | blank brut bright | verzinkt zingué galvanised |
|---|-------------------------|----------------------------------|
|  | mm | mm |
| 01.634 | 350 | |
| 01.684 | 450 | 900 |

| | mm | mm |
|---|-----|------|
|  | | |
| 02.634 | 350 | 600 |
| 02.684 | | 1050 |

| | mm |
|--|------|
|  | |
| 04.637 | 1550 |

| | mm |
|---|------|
|  | |
| 05.637 | 1550 |

| | mm | mm |
|---|-----|------|
|  | | |
| 400.052 | 900 | 1100 |
| 400.054 | | 1000 |
| 400.055 | | 700 |

| Stahl-Glasleisten Parcloles en acier Steel glazing beads | Min. Radius Rayon min. Min. radius R |
|--|---|
|--|---|

| | |
|---|---------|
|  | |
| 402.112 Z | 500 mm |
| 402.115 Z | 500 mm |
| 402.120 Z | 600 mm |
| 402.125 Z | 750 mm |
| 402.130 Z | 1000 mm |
| 402.135 Z | 1500 mm |

| Profil Profilé Profile | Min. Radius Rayon min. Min. radius R |
|------------------------------|---|
|------------------------------|---|

| | |
|--|--------|
|  | |
| 20/15/1,5 | 300 mm |
| 20/20/1,5 | 300 mm |
| 20/25/1,5 | 400 mm |
| 20/30/1,5 | 500 mm |
| 20/35/1,5 | 500 mm |

| Stahl-Glasleisten Parcloles en acier Steel glazing beads | Min. Radius Rayon min. Min. radius R |
|--|---|
|--|---|

| | |
|---|--------|
|  | |
| 62.507 Z | 300 mm |
| 62.508 Z | 300 mm |
| 62.509 Z | 300 mm |

Die Radien-Angaben beziehen sich auf die langjährige Erfahrung und Fertigung im Hause Jansen.

Les rayons indiqués se fondent sur la longue expérience et la fabrication au sein de la maison Jansen.

The radii specifications are based on the many years of experience Jansen has in fabrication.

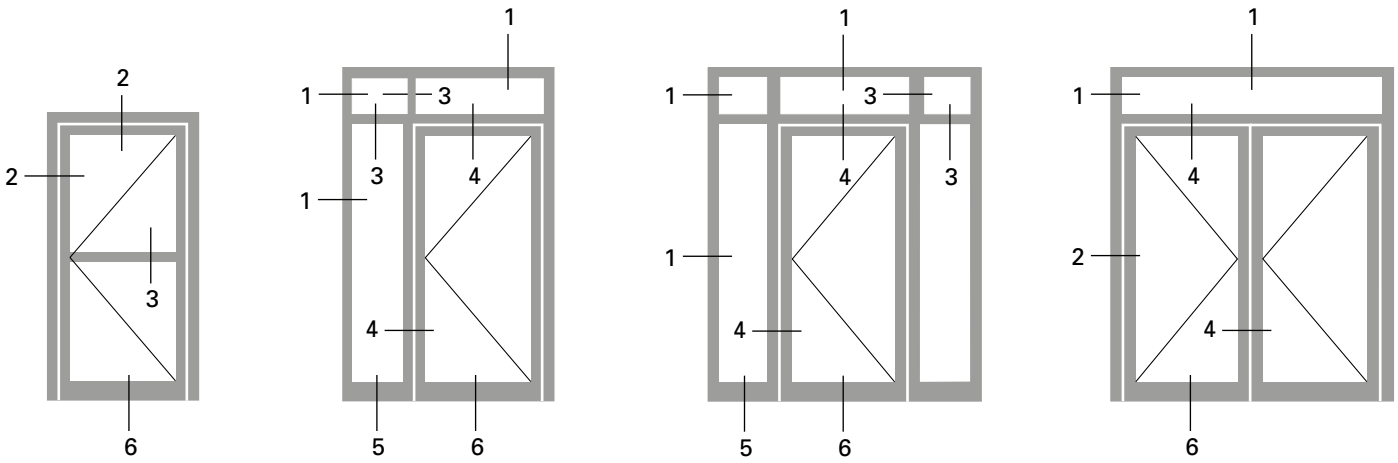

1.0

3.0

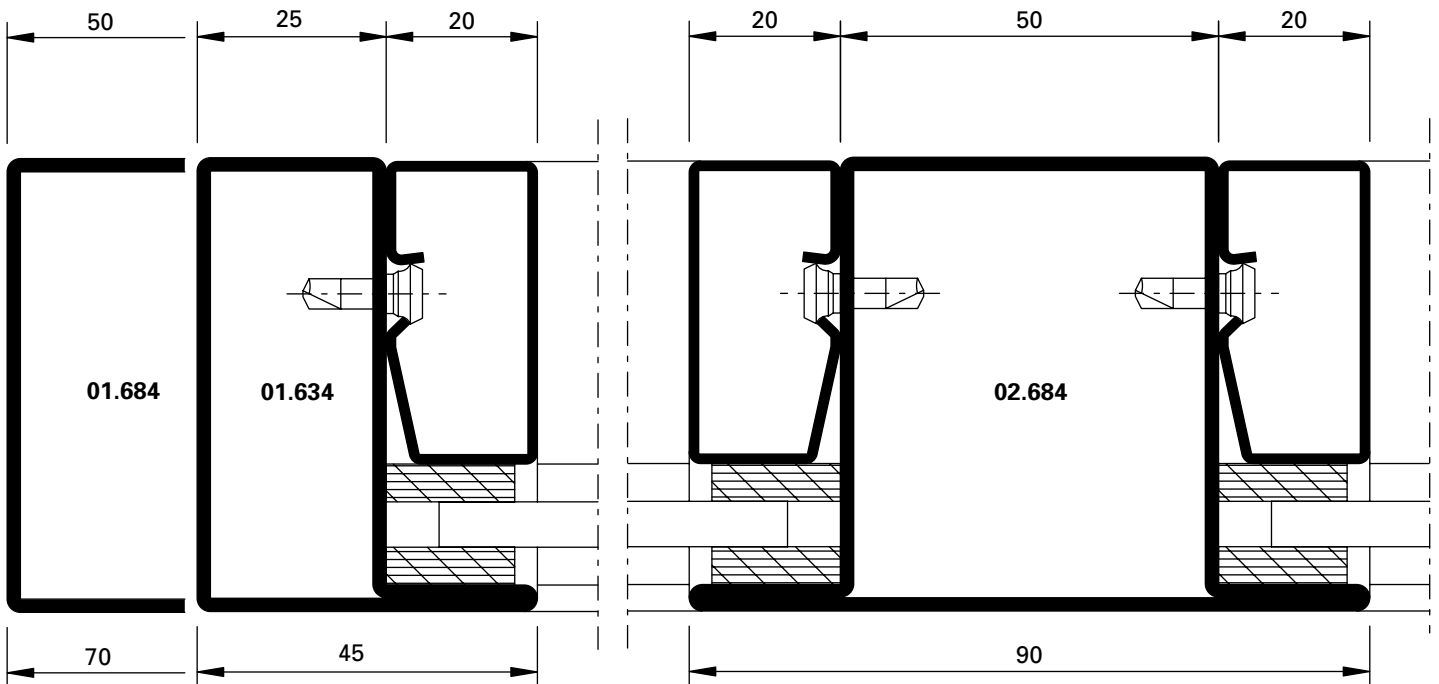

DXF **DWG** 41-0302-C-001

DXF **DWG** 41-0302-C-002

2.0

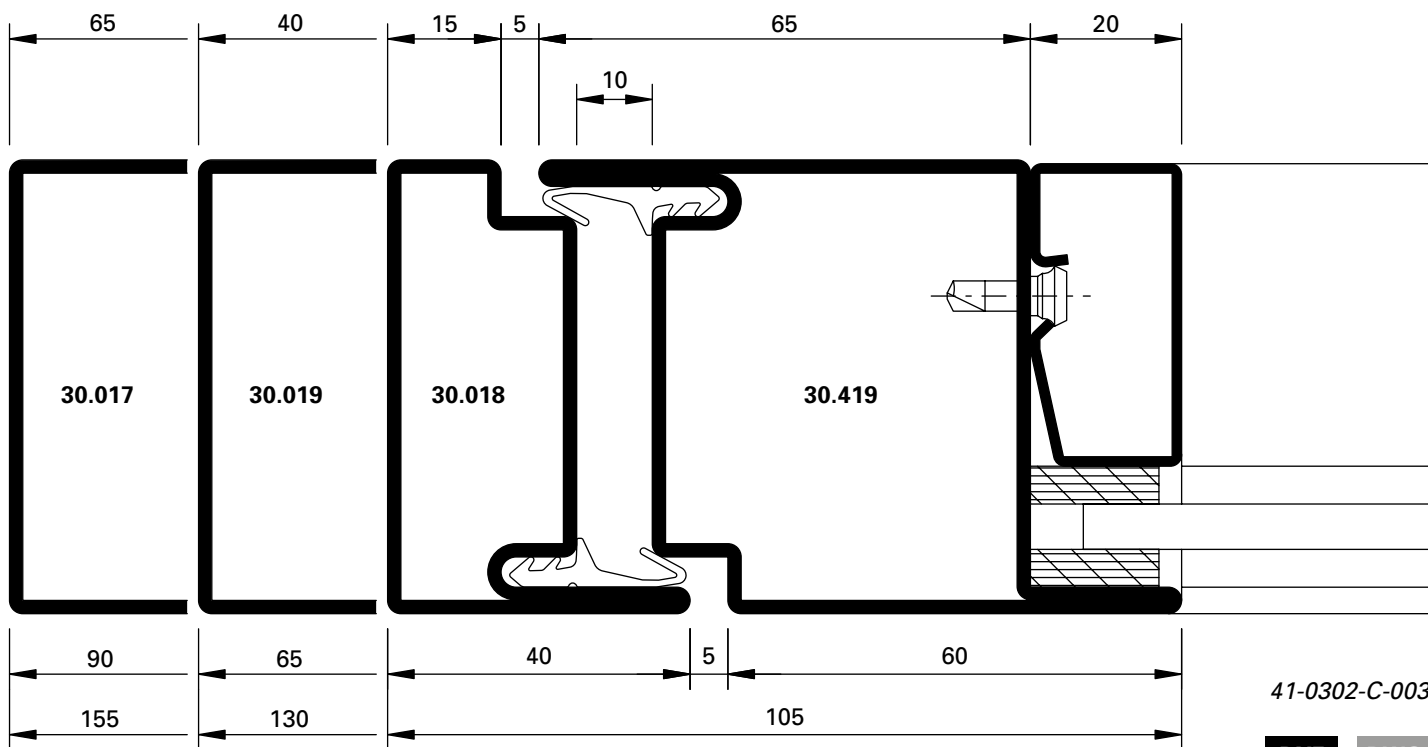

41-0302-C-003

DXF DWG

2.1

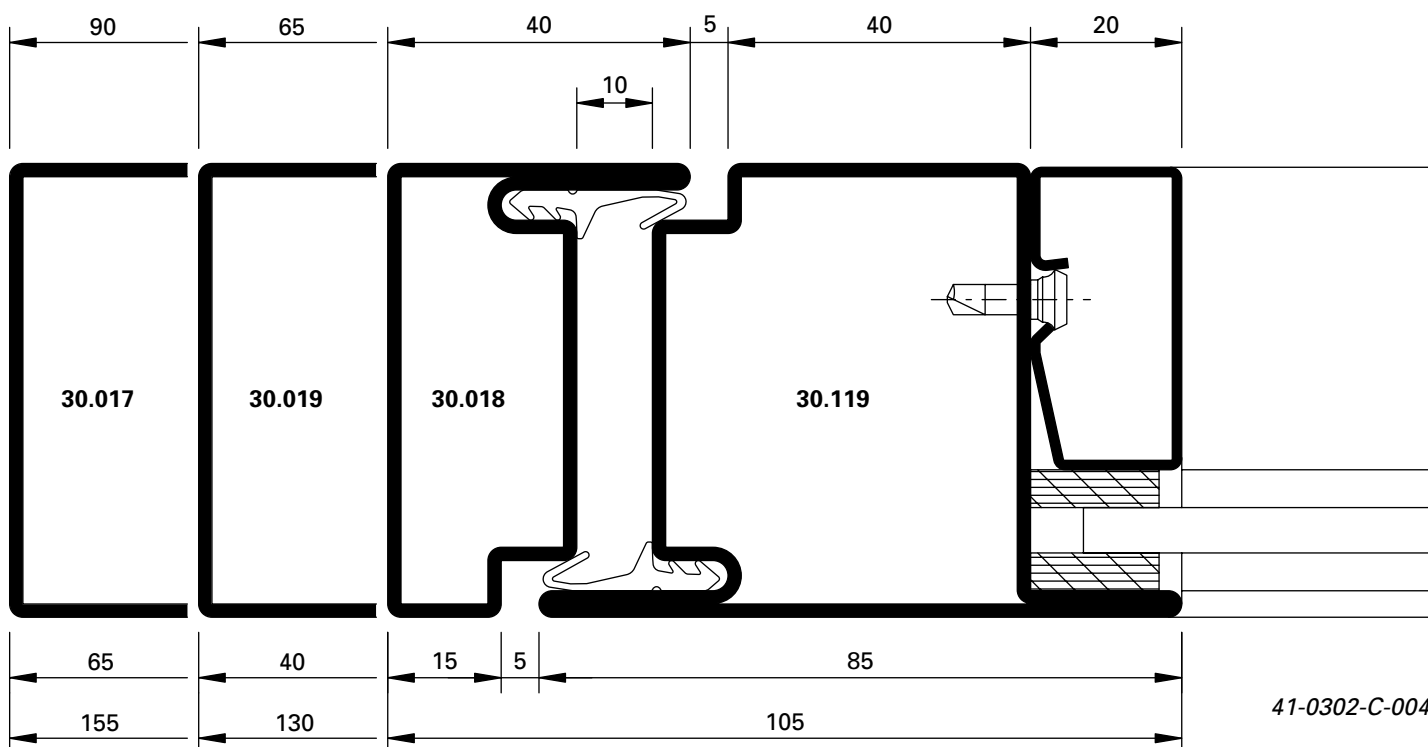

41-0302-C-004

DXF DWG

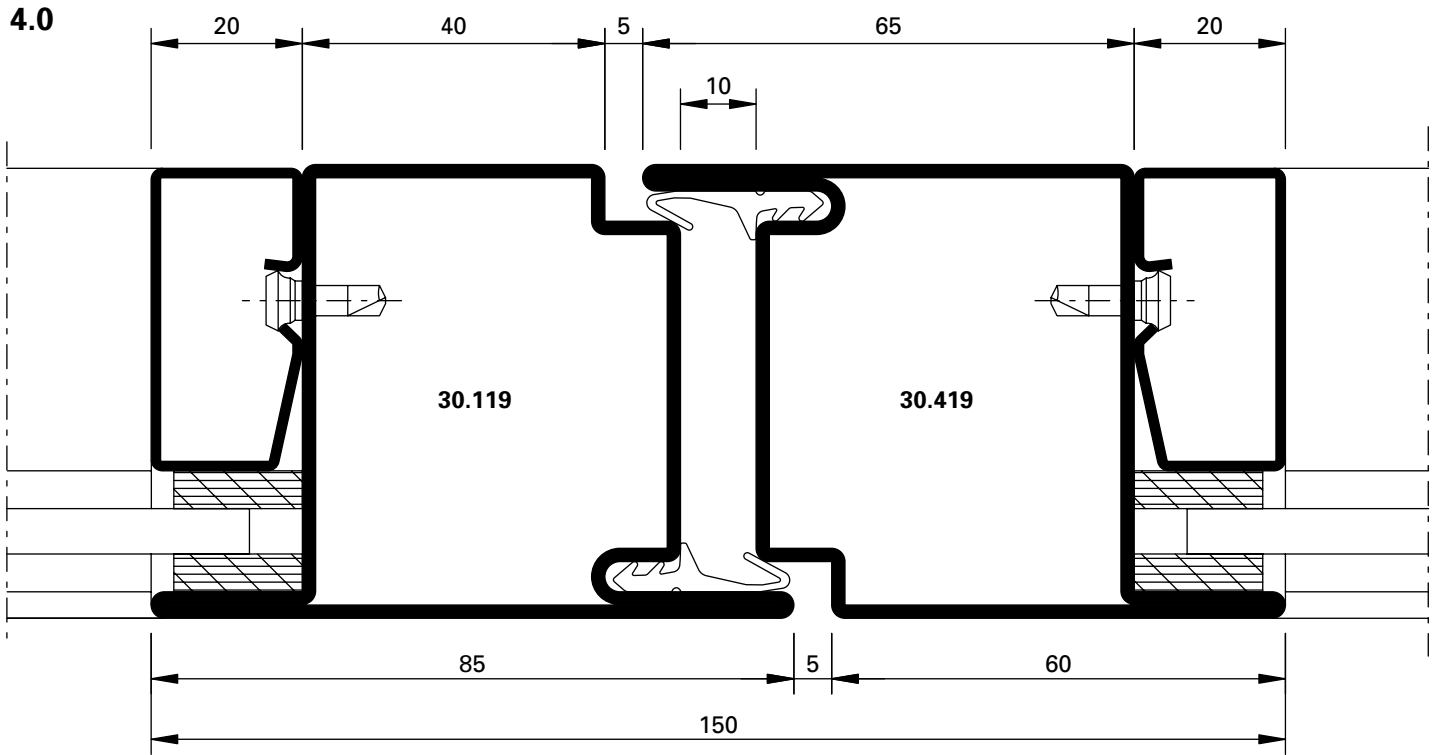

DXF **DWG** 41-0302-C-005

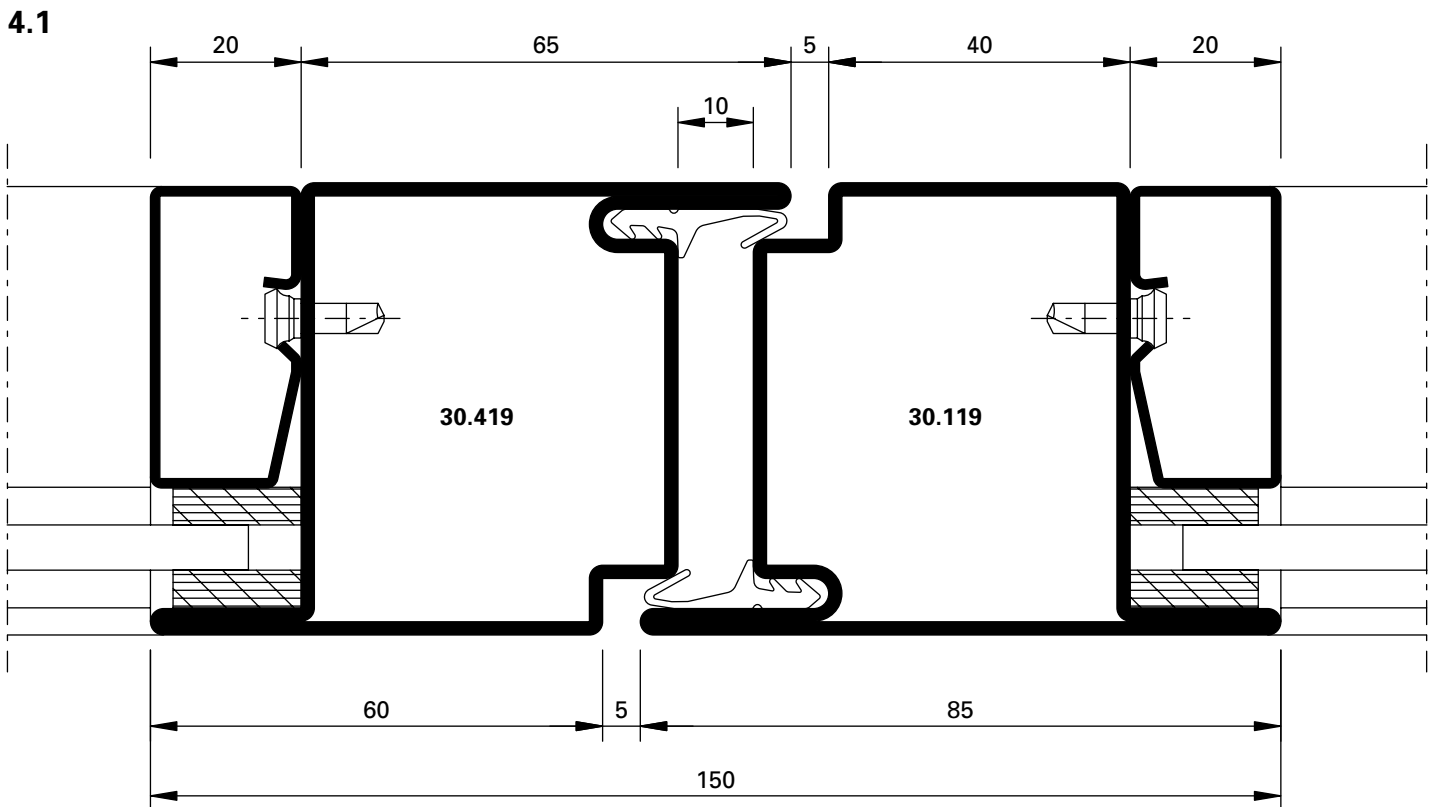

DXF **DWG** 41-0302-C-006

6.0

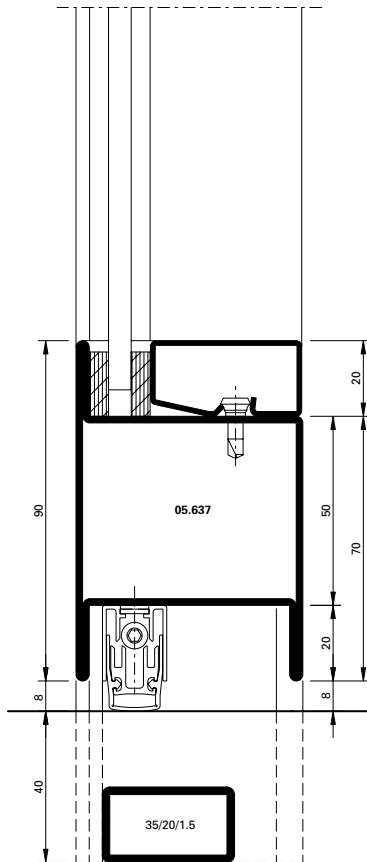

41-0302-C-008

DWG

DXF

6.1

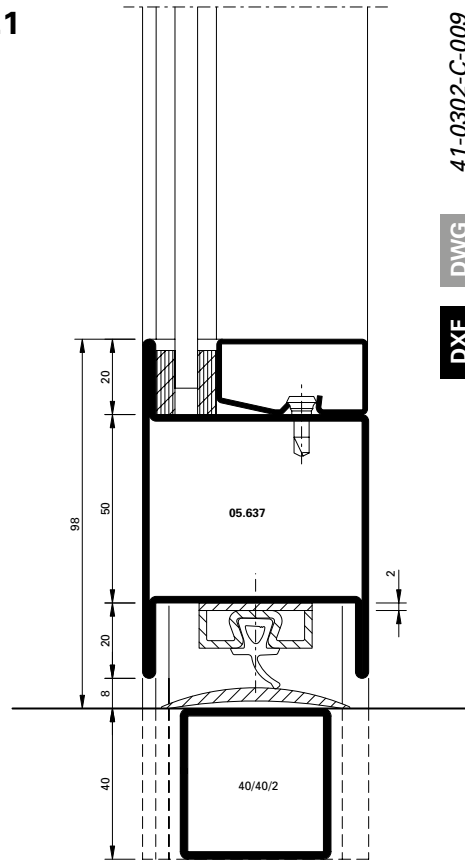

41-0302-C-009

DWG

DXF

6.2

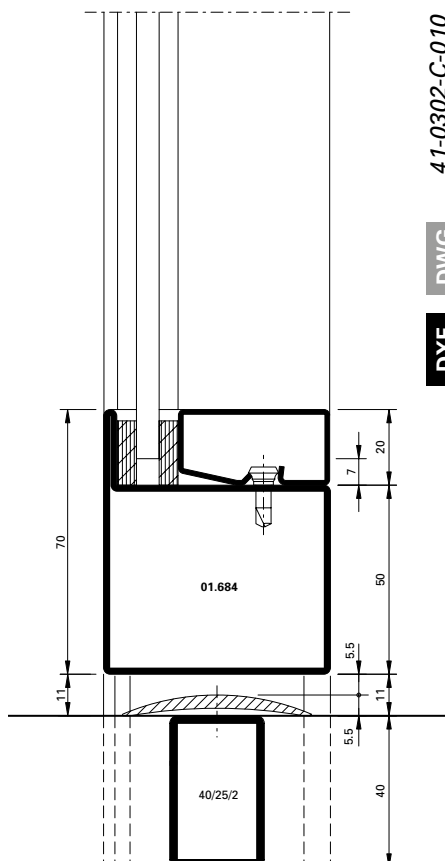

41-0302-C-010

DWG

DXF

Glasleisten-Varianten im Masstab 1:2

Variantes de parcloles à l'échelle 1:2

Glazing bead options on scale 1:2

Jansen-Economy 60 E30

Jansen-Economy 60 E30

Jansen-Economy 60 E30

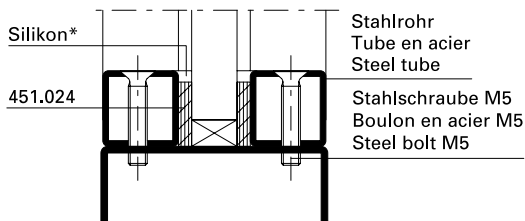
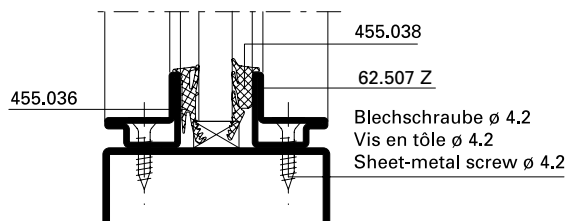
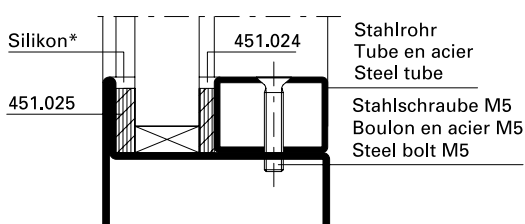
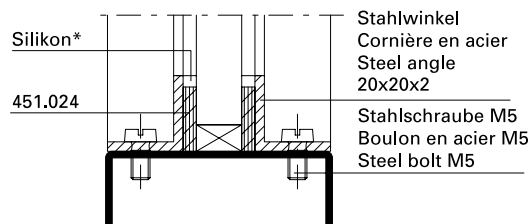
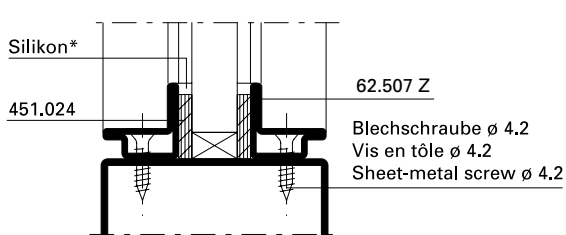
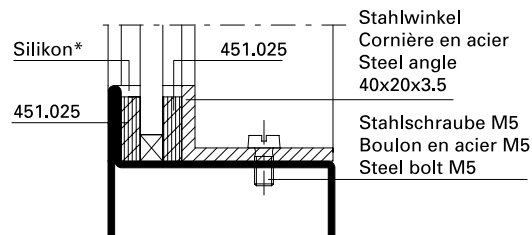
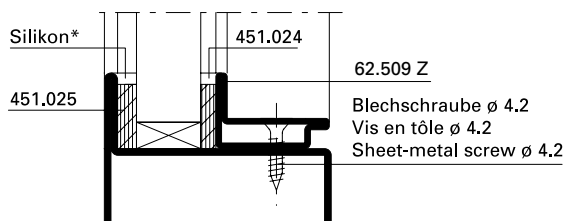
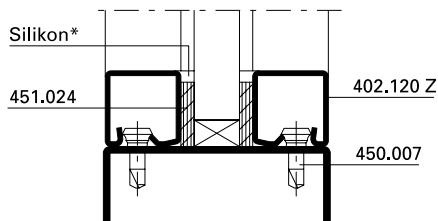
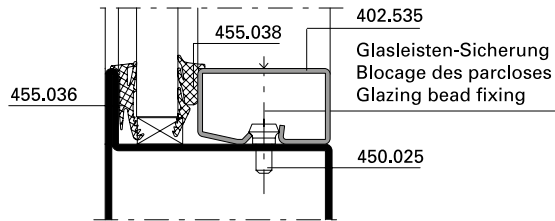
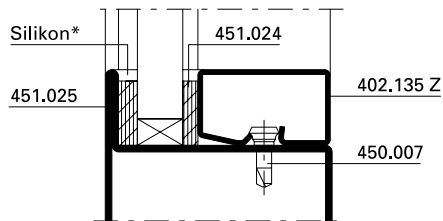

* Brandschutz-Silikon wahlweise

* Silicon difficilement combustible
au choix

* Fire resistant silicone optional

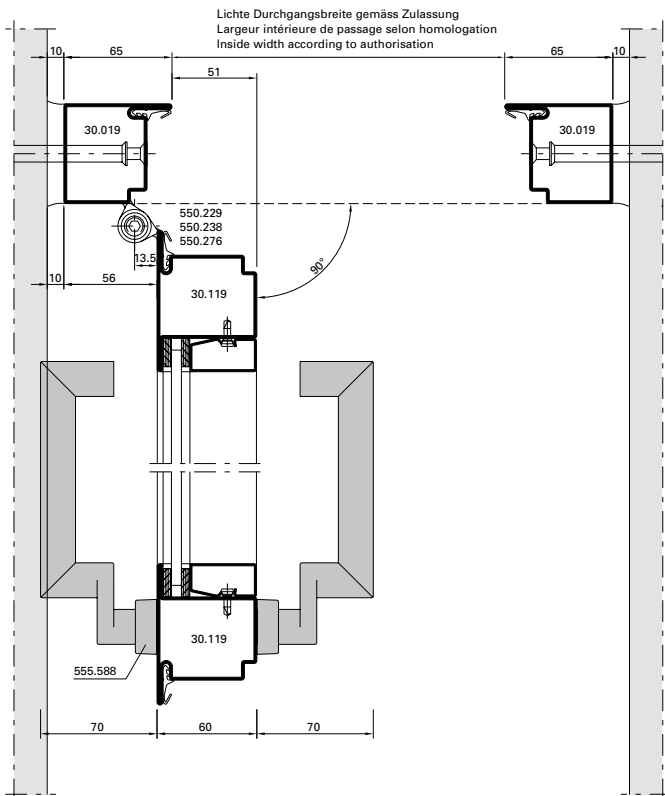

DXF **DWG** 41-0302-E-023

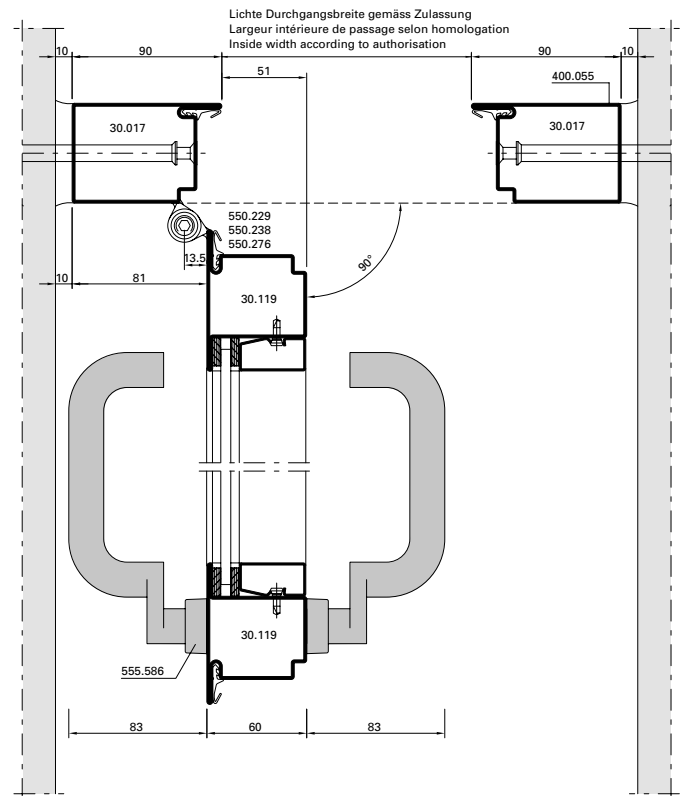

DXF **DWG** 41-0302-E-024

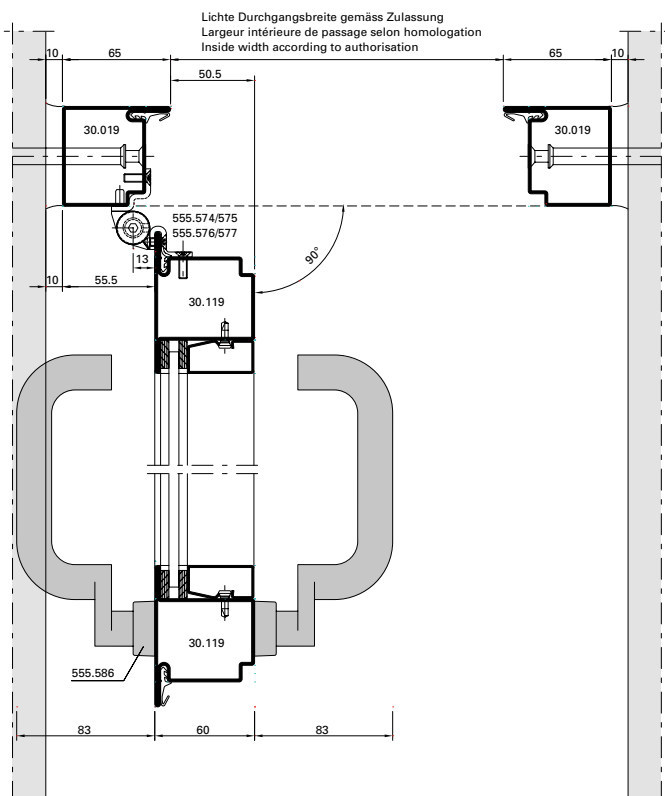

DXF **DWG** 41-0302-E-025

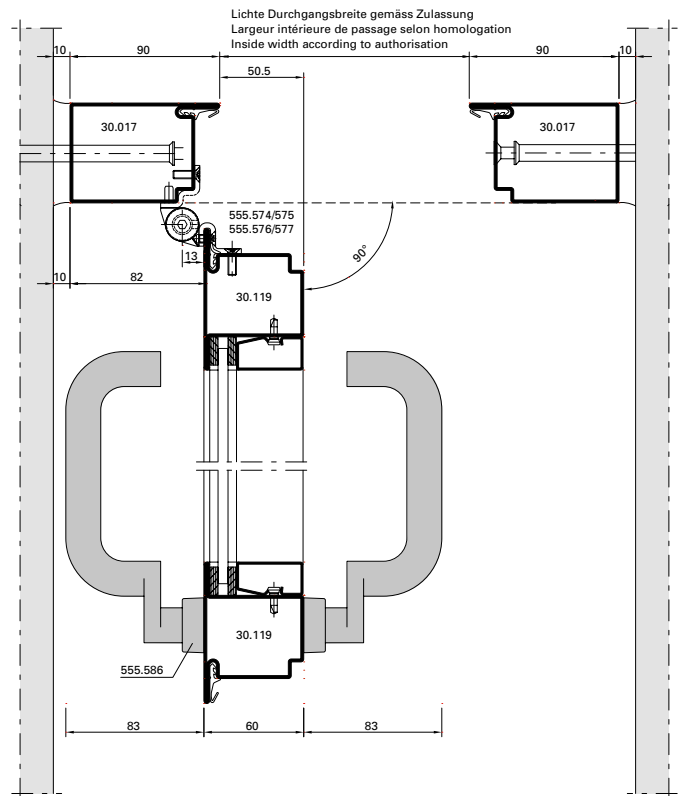

DXF **DWG** 41-0302-E-026

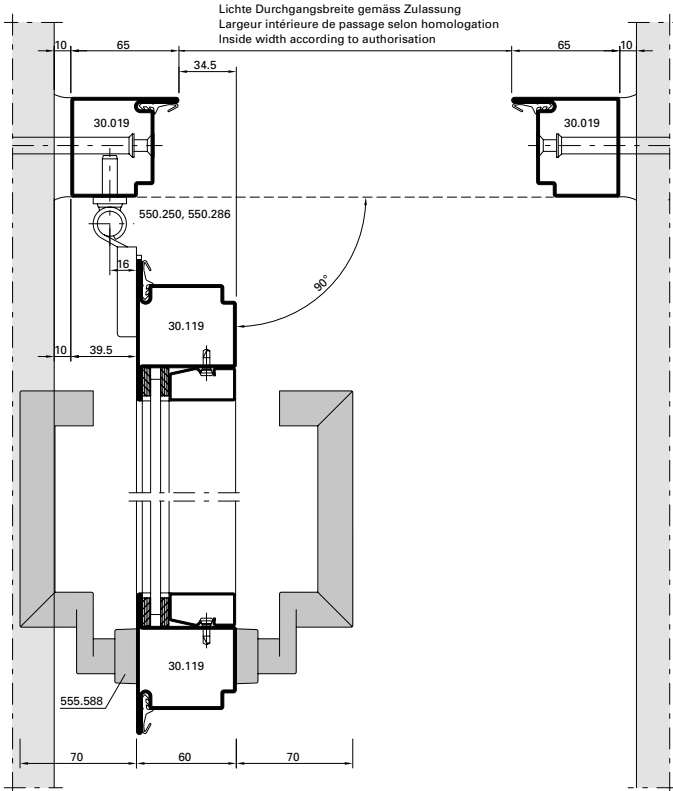

DXF **DWG** 41-0302-E-027

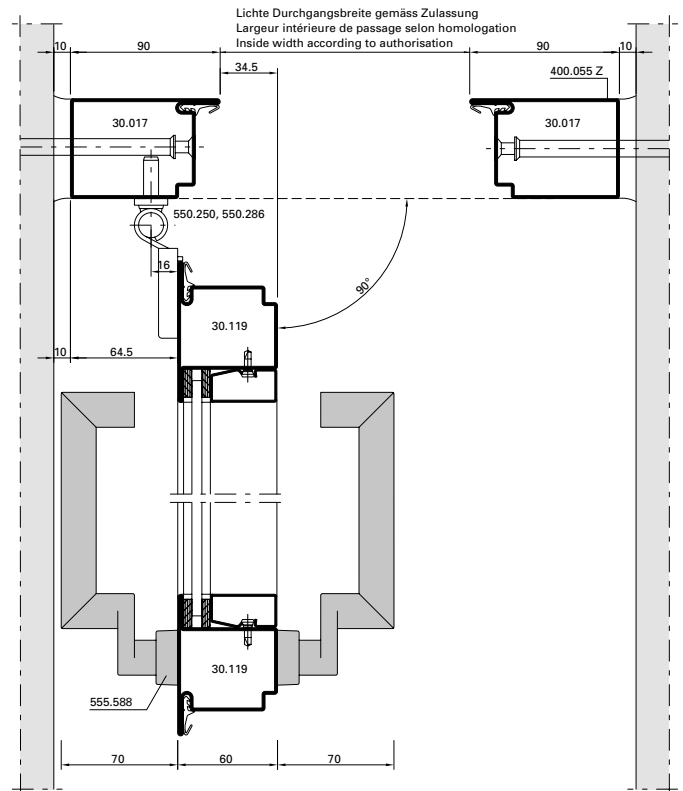

DXF **DWG** 41-0302-E-028

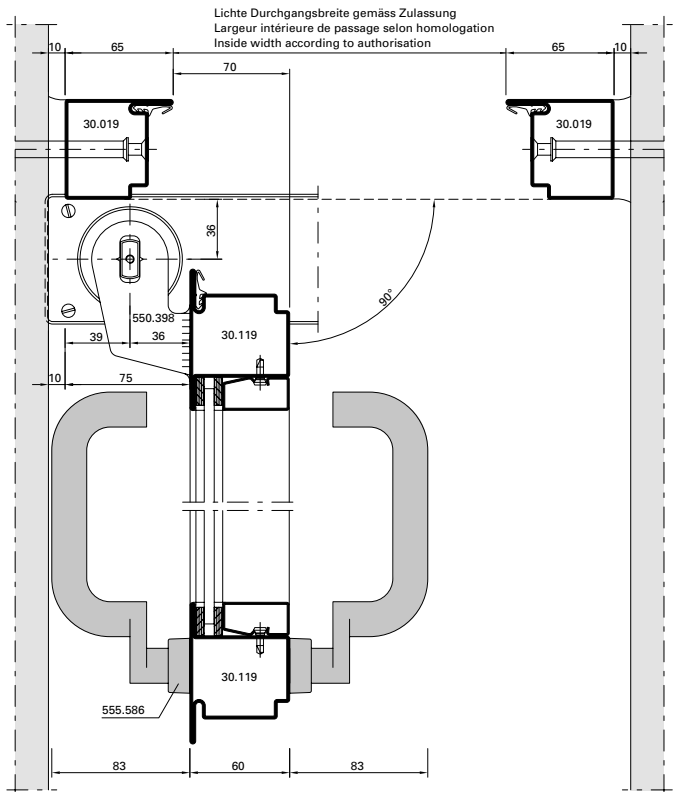

DXF **DWG** 41-0302-E-029

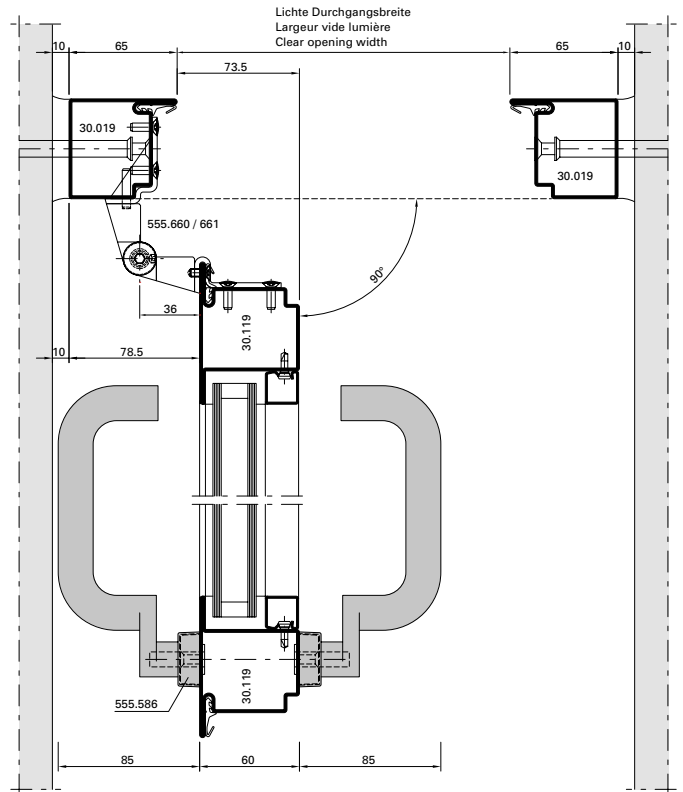

DXF **DWG** 41-0302-E-034

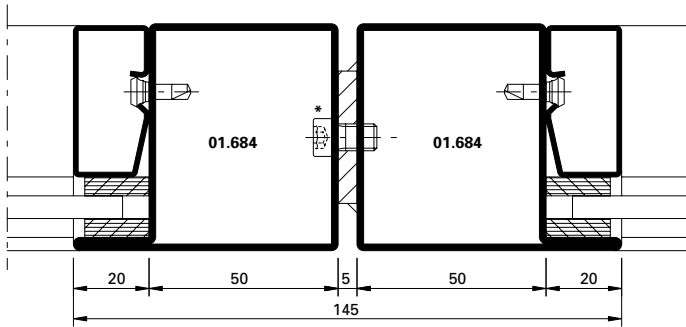

DXF **DWG** 41-0302-K-001

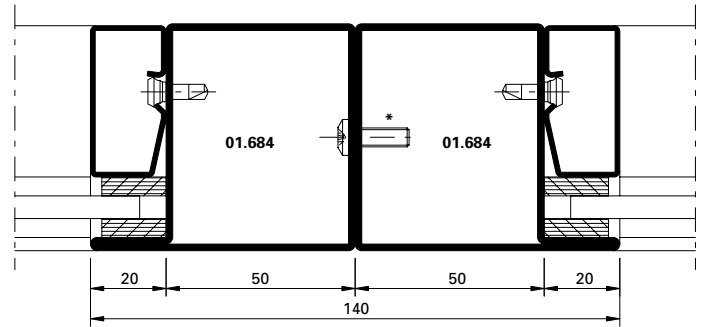

DXF **DWG** 41-0302-K-021

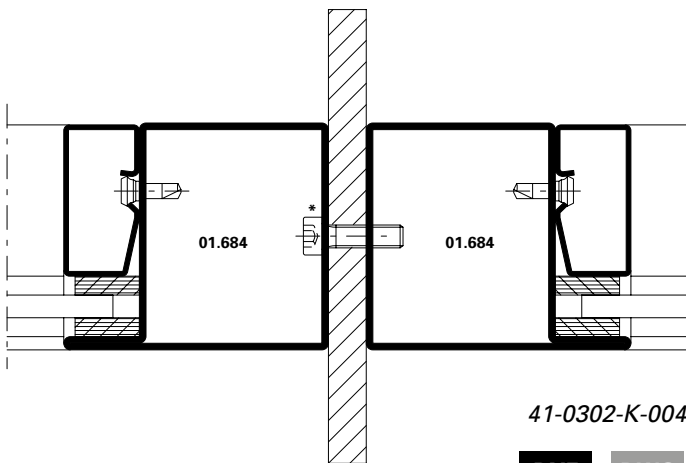

41-0302-K-004

DXF **DWG**

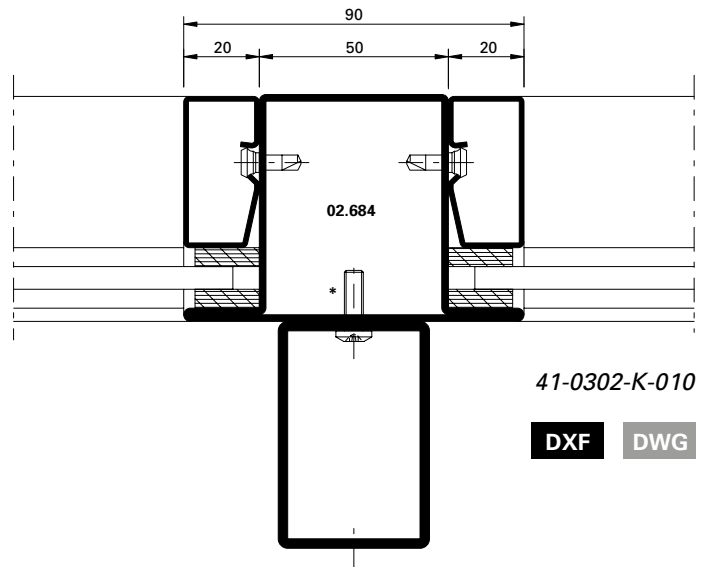

41-0302-K-010

DXF **DWG**

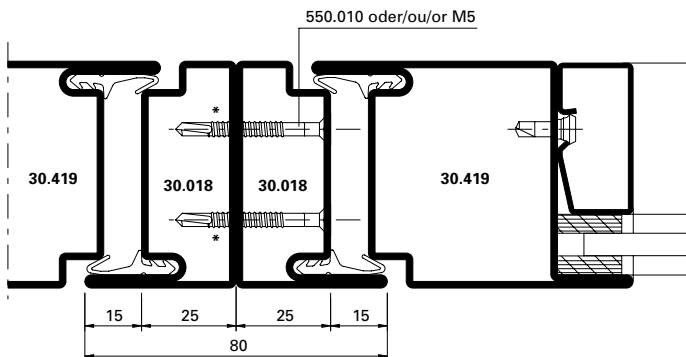

DXF **DWG** 41-0302-K-019

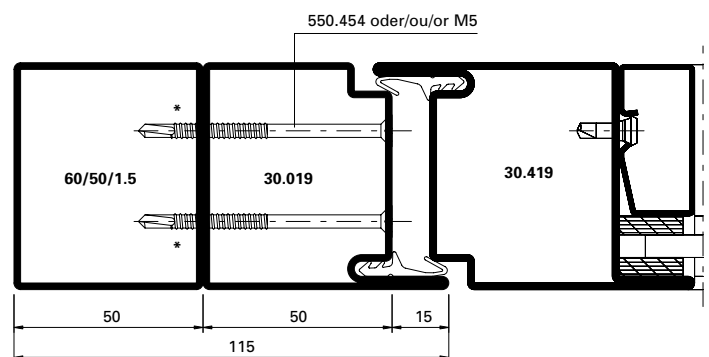

DXF **DWG** 41-0302-K-018

* Schrauben-Abstand \leq 500 mm

* Distance des vis \leq 500 mm

* Screw distance \leq 500 mm

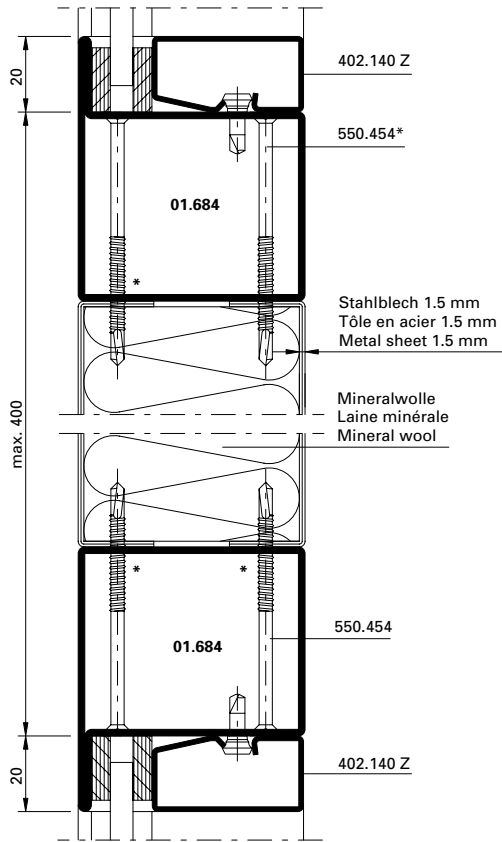

41-0302-K-011

DWG

DXF

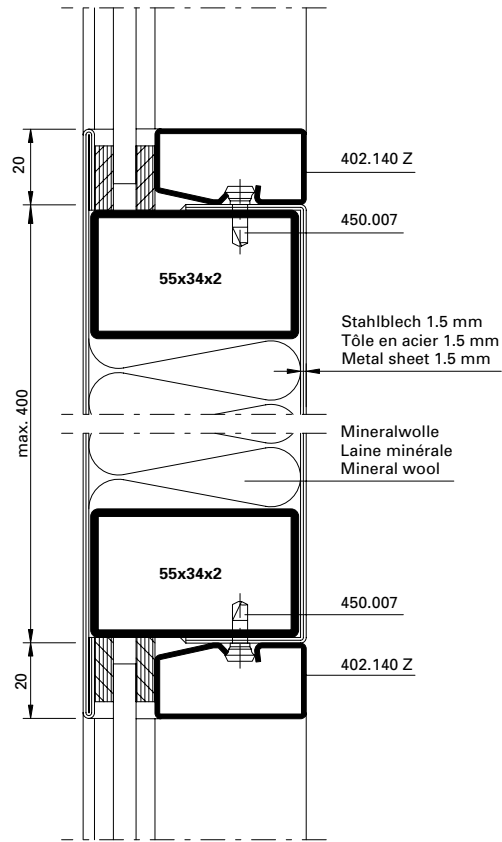

41-0302-K-012

DWG

DXF

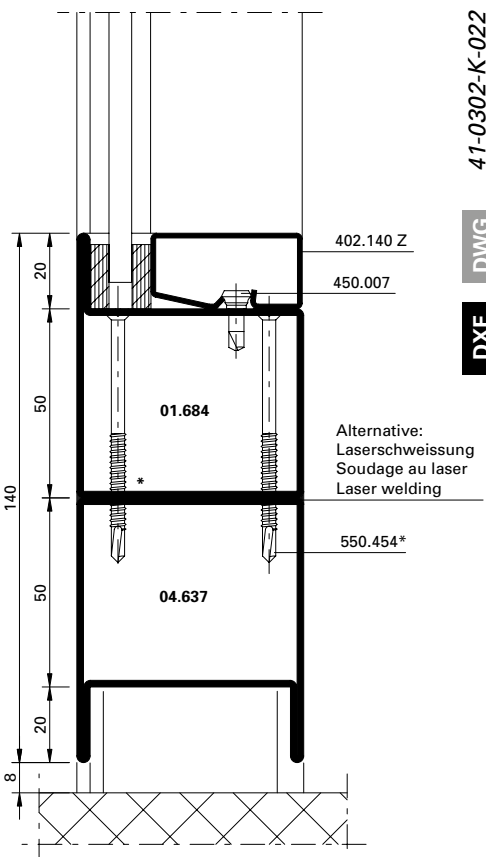

41-0302-K-022

DWG

DXF

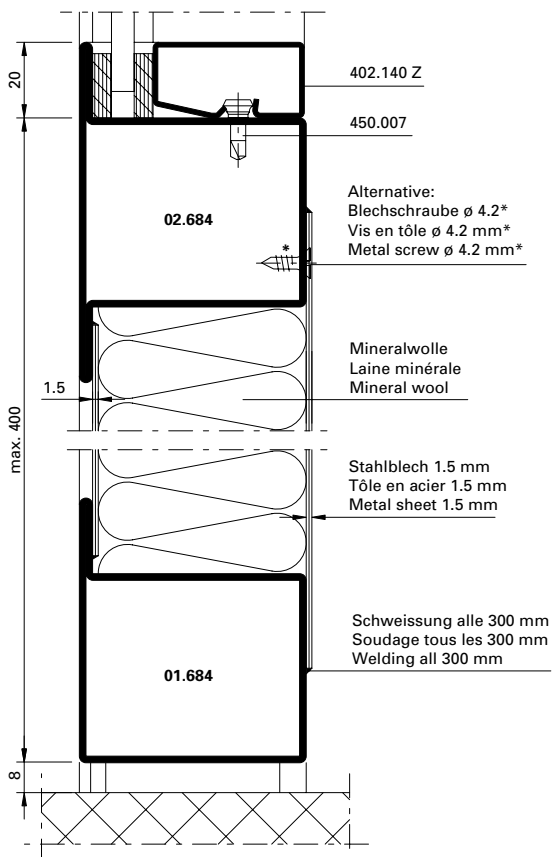

41-0302-K-023

DWG

DXF

* Schrauben-Abstand \leq 500 mm

* Distance des vis \leq 500 mm

* Screw distance \leq 500 mm

T-Verbinder schraubbar

Raccord en T à visser

Screwable connecting spigot

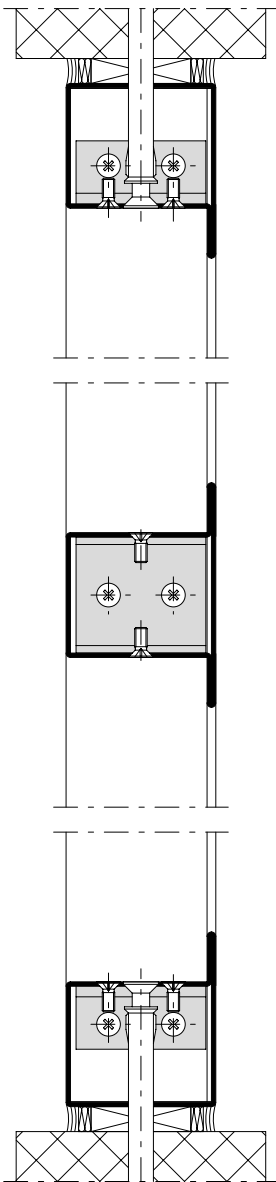

Stahlschraube M5 wahlweise Blindnietmutter M5
 Boulon en acier M5 au choix écrou rivet aveugle M5
 Steel bolt M5 optional blind rivet nut M5

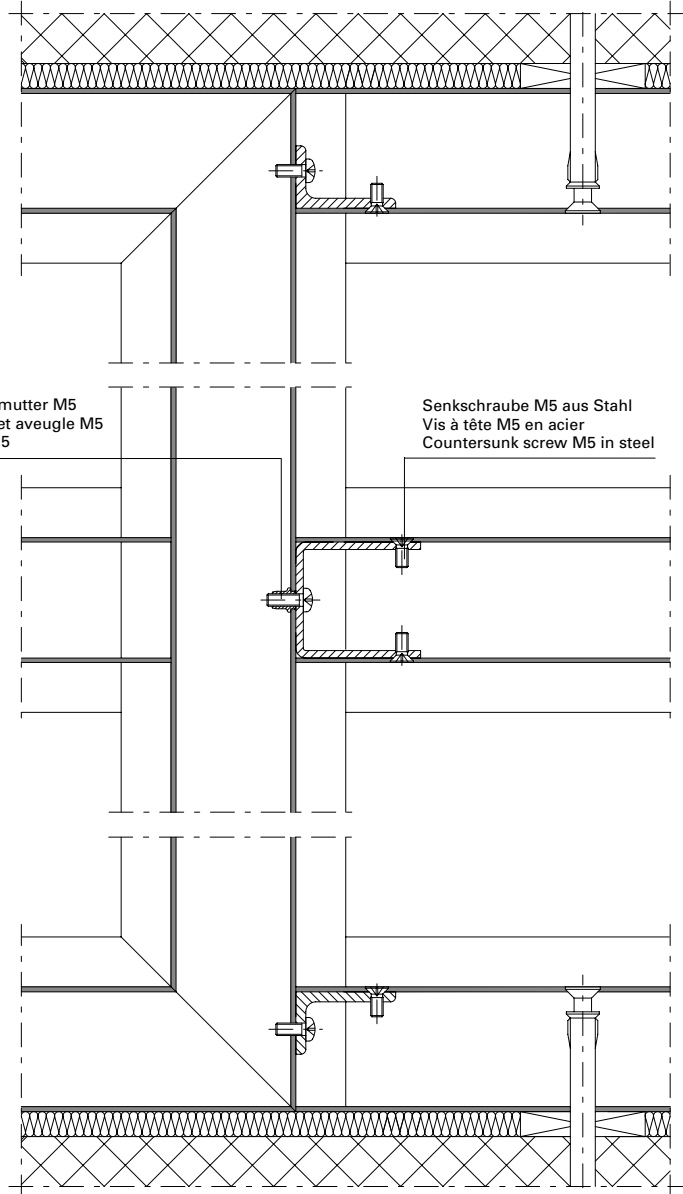

Senkschraube M5 aus Stahl
 Vis à tête M5 en acier
 Countersunk screw M5 in steel

T-Verbinder aus Winkelstahl*
 Raccord en T en cornière en acier*
 Connecting spigot in steel angle*

T-Verbinder aus U-Profil*
 Raccord en T en profilé en U*
 Connecting spigot in U profile*

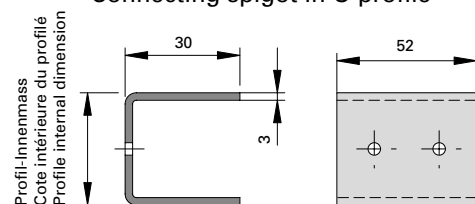
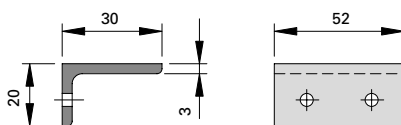

* Durch Metallbauer herzustellen

* A fabriquer par le constructeur

* To be manufactured by metal worker

Element-Kopplungen

Couplages d'éléments

Coupling element

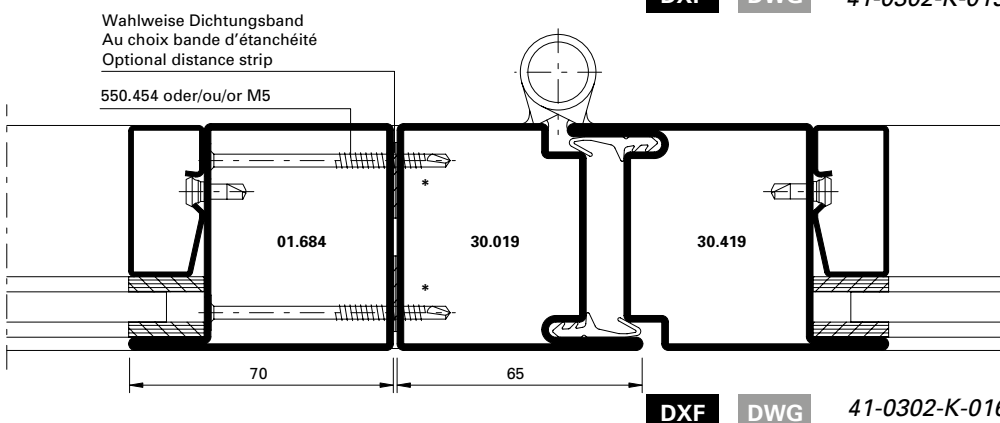
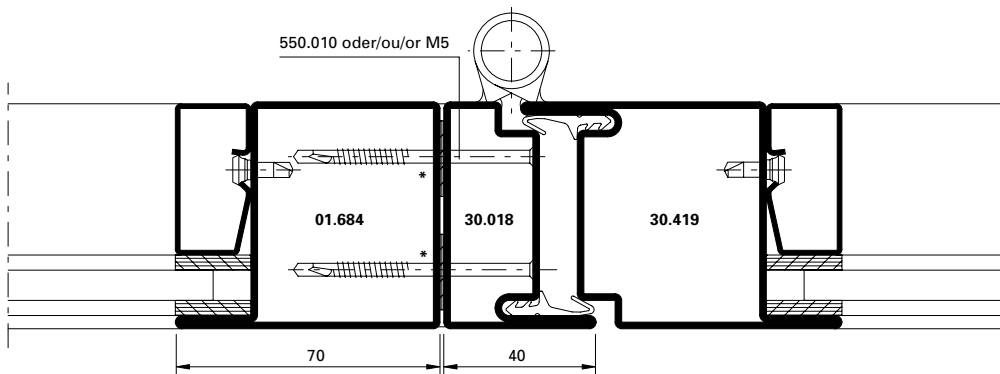
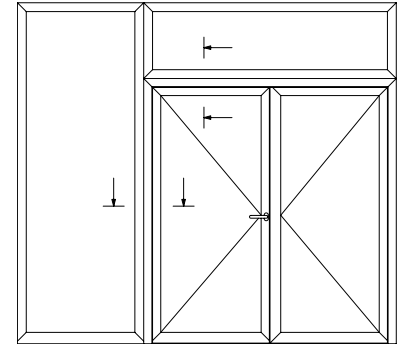
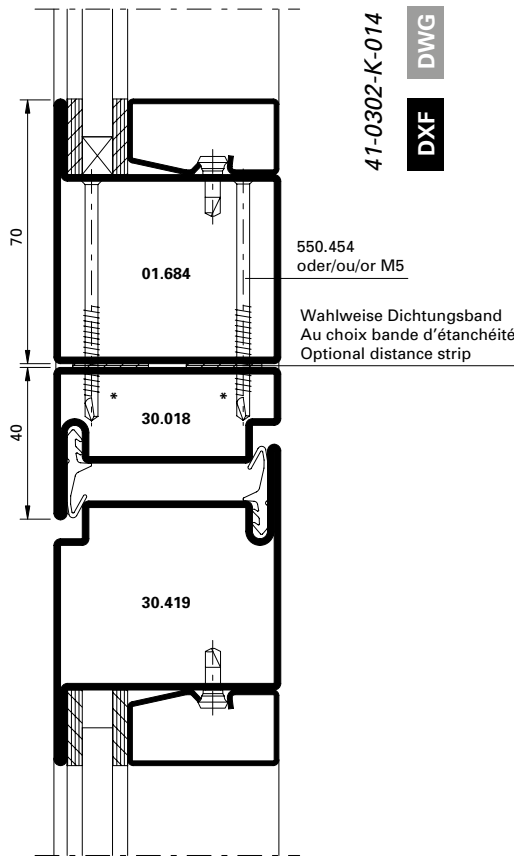
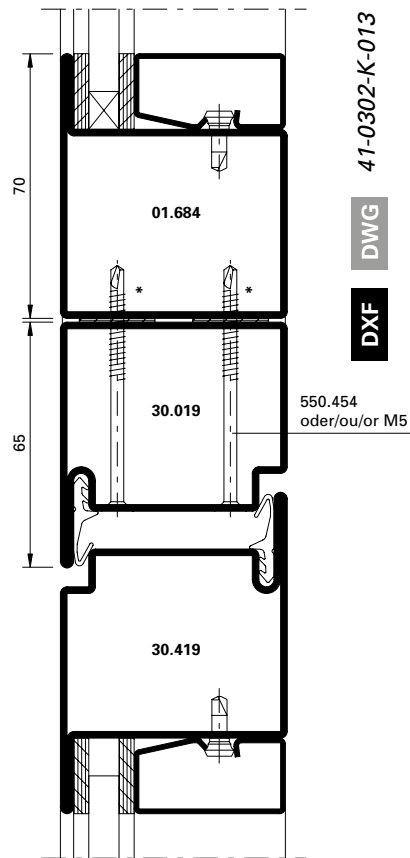

- * Schrauben-Abstand ≤ 500 mm
- * Distance des vis ≤ 500 mm
- * Screw distance ≤ 500 mm

Anschlüsse am Bau im Masstab 1:2
Raccords au mur à l'échelle 1:2
Attachment to structure on scale 1:2

Jansen-Economy 60 E30
 Jansen-Economy 60 E30
 Jansen-Economy 60 E30

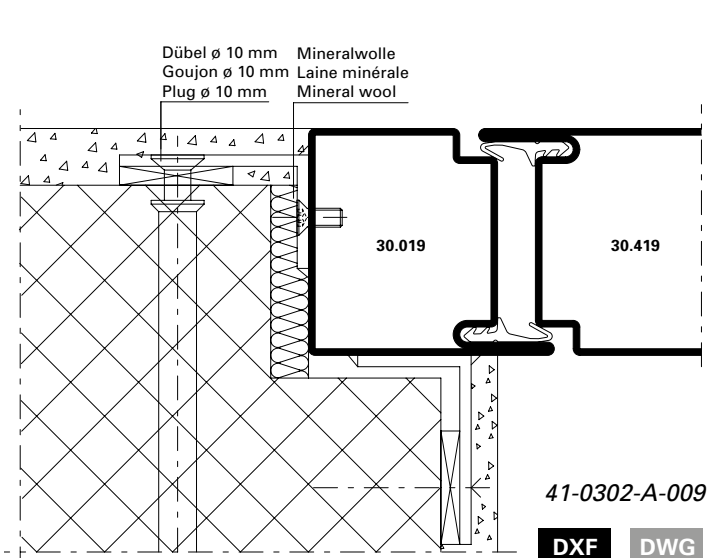
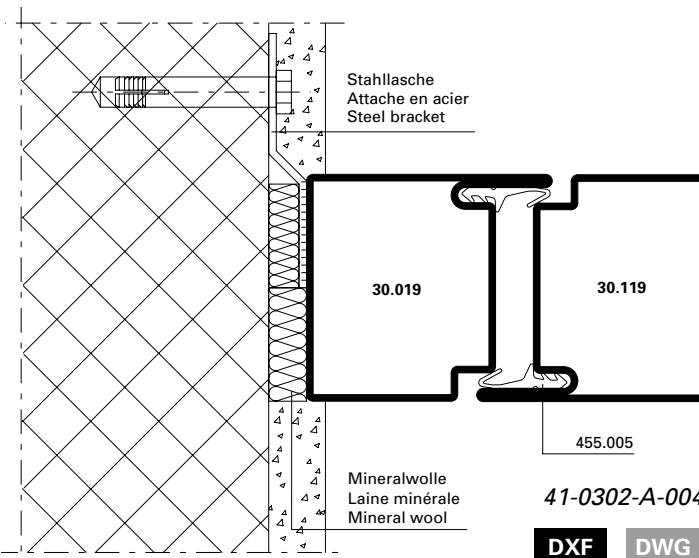
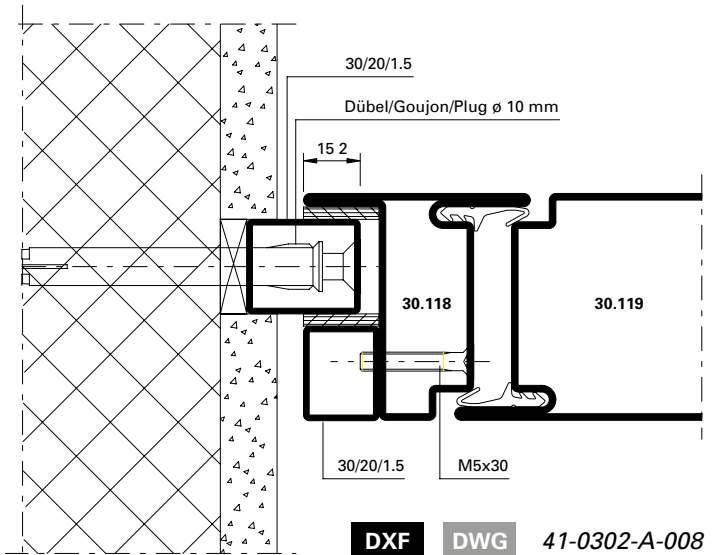
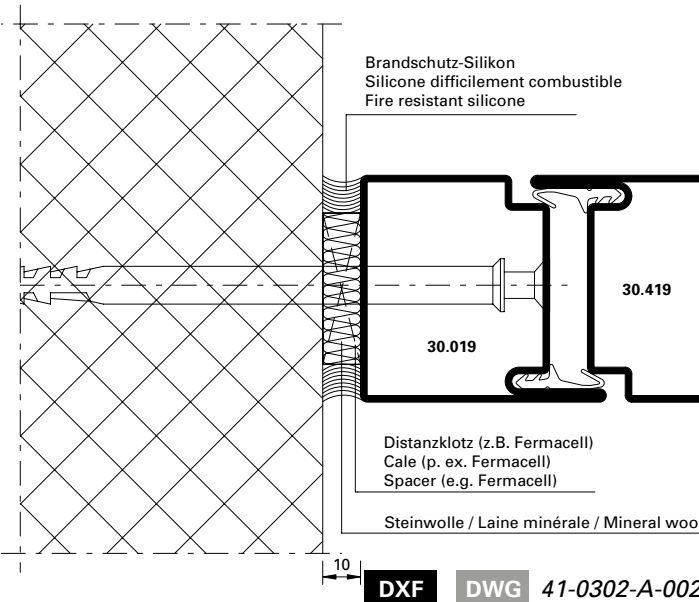
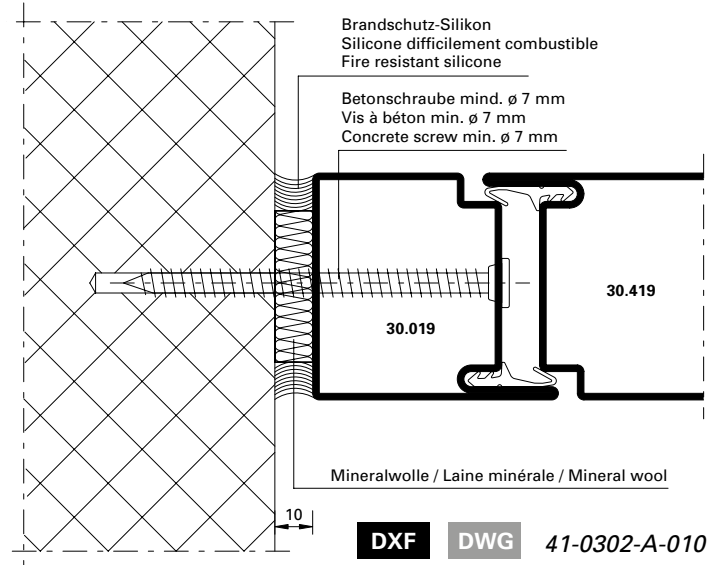
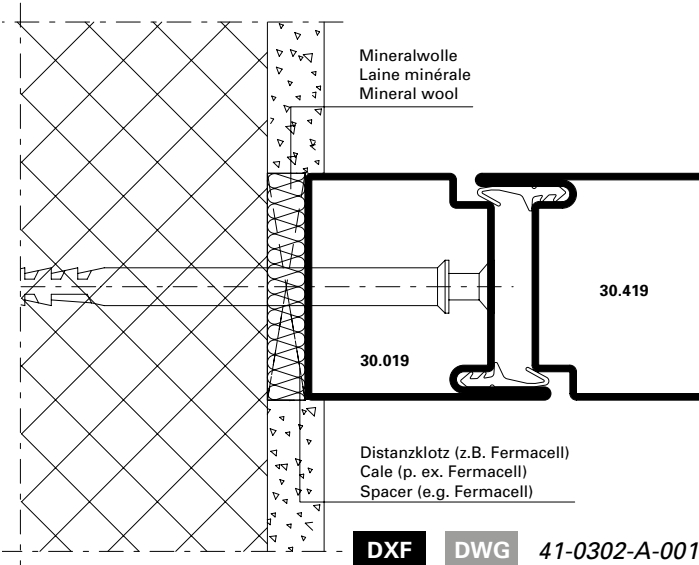

Anschlüsse am Bau im Massstab 1:2
Raccords au mur à l'échelle 1:2
Attachment to structure on scale 1:2

Jansen-Economy 60 E30
 Jansen-Economy 60 E30
 Jansen-Economy 60 E30

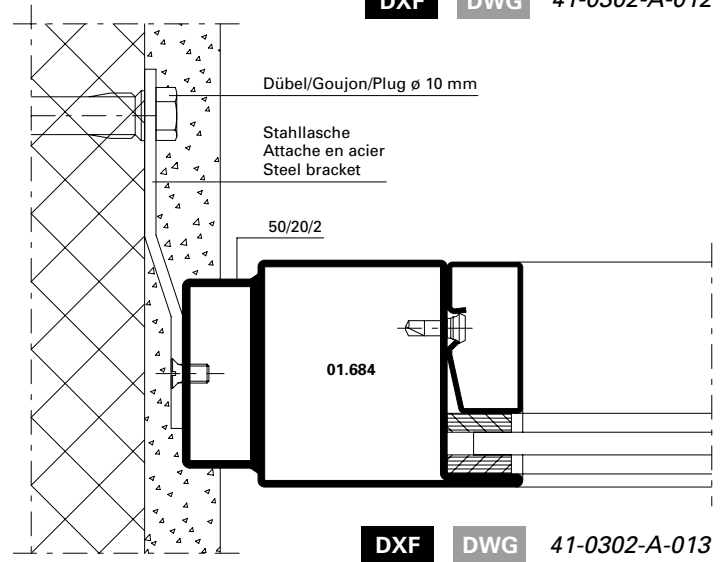
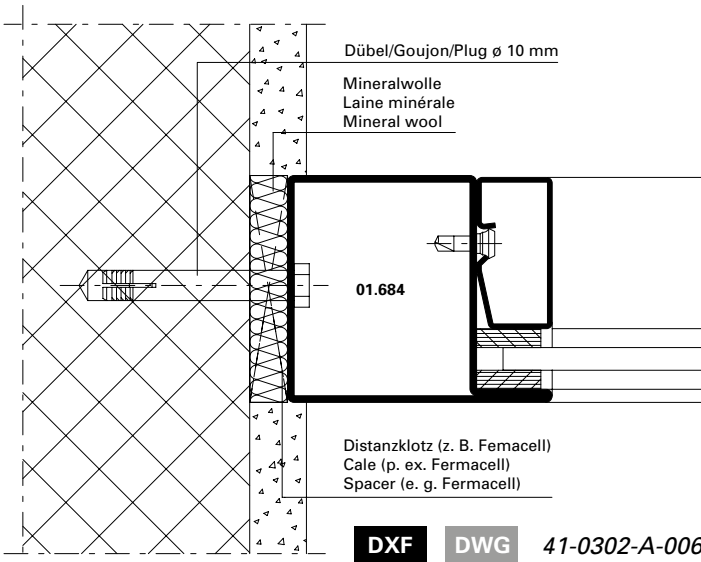
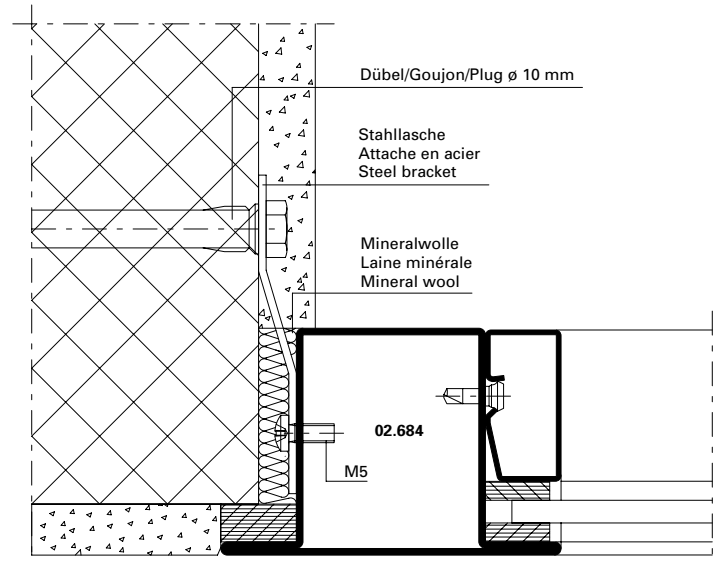
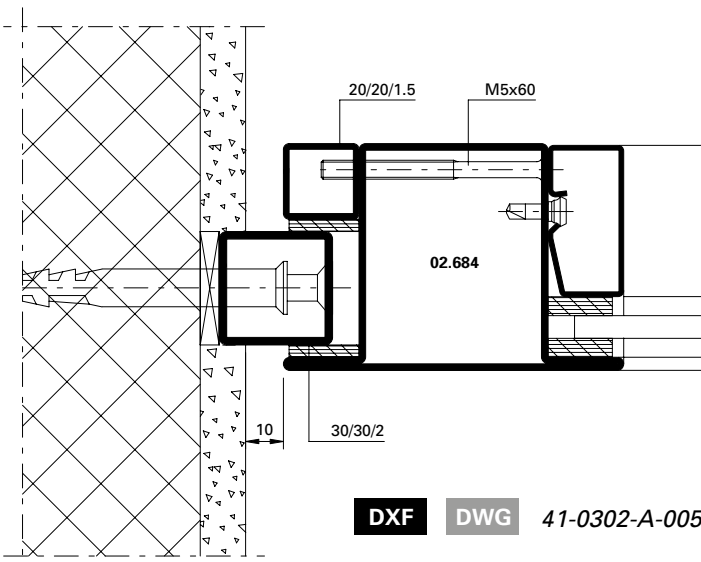
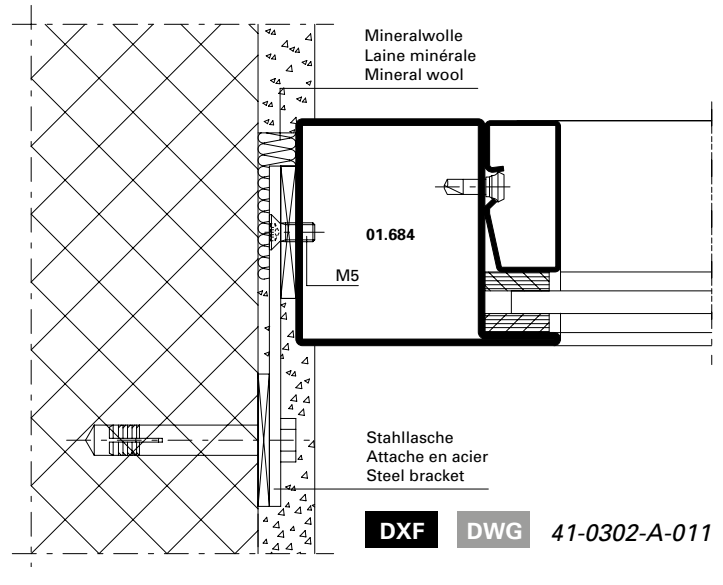
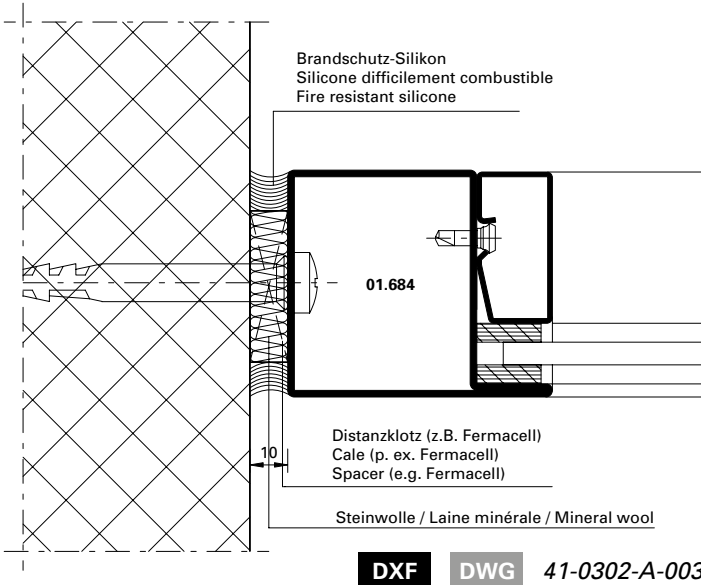

Anschlüsse am Bau im Massstab 1:2
Raccords au mur à l'échelle 1:2
Attachment to structure on scale 1:2

Jansen-Economy 60 E30
 Jansen-Economy 60 E30
 Jansen-Economy 60 E30

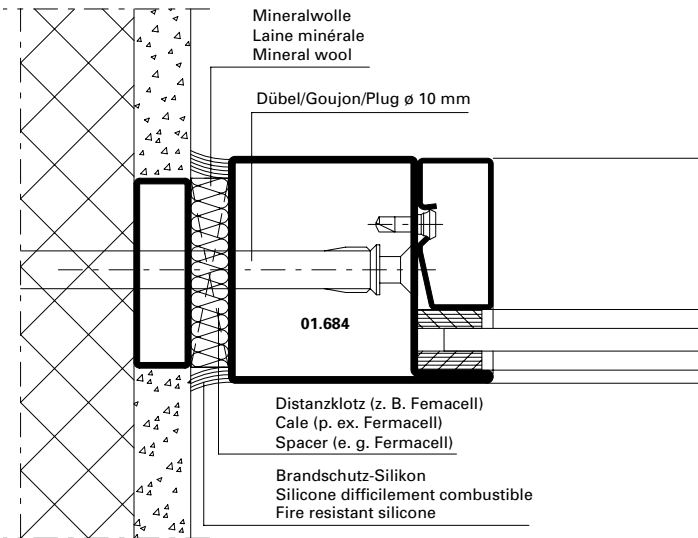

DXF DWG 41-0302-A-014

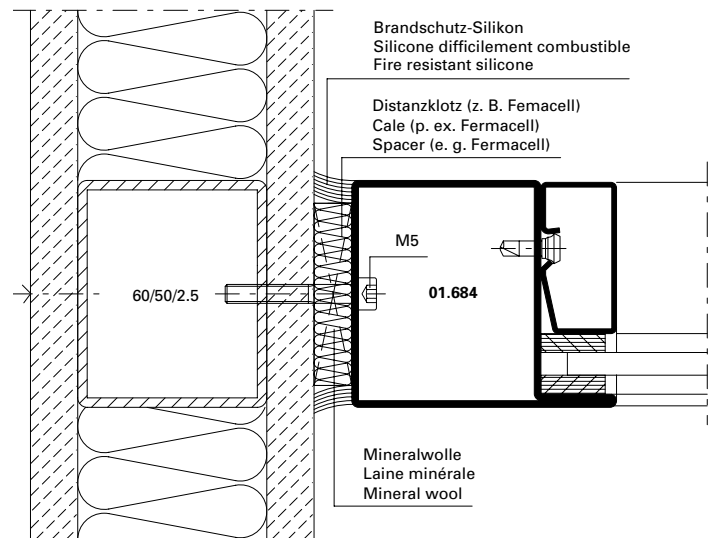

DXF DWG 41-0302-A-018

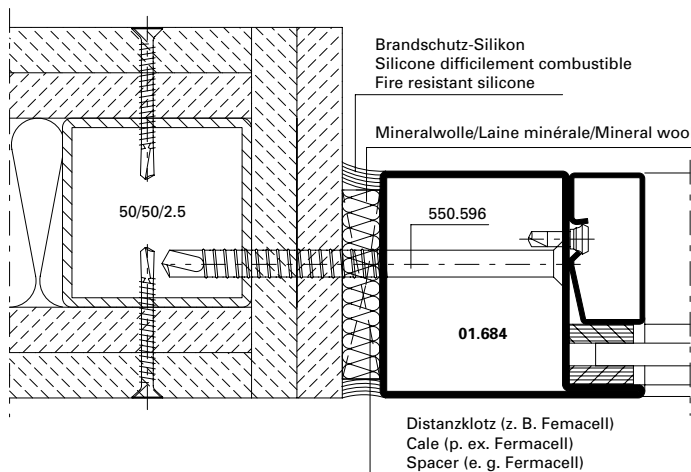

DXF DWG 41-0302-A-015

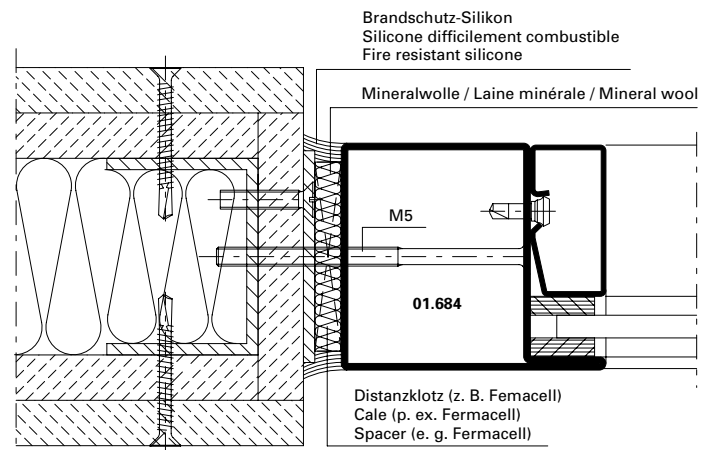

DXF DWG 41-0302-A-016

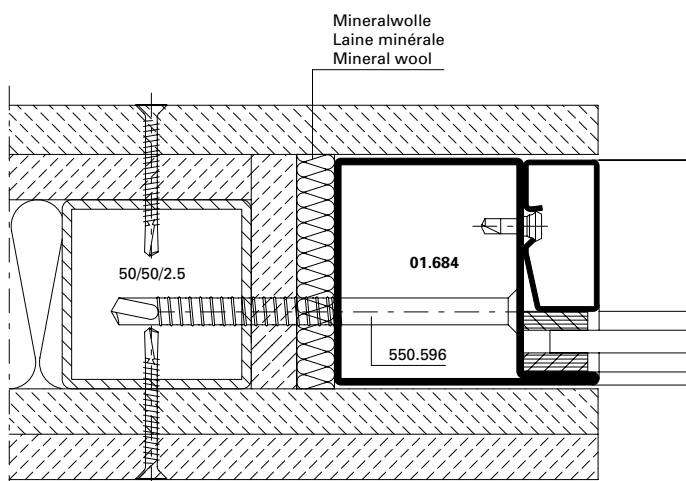

DXF DWG 41-0302-A-017

41-0302-A-019

DXF DWG

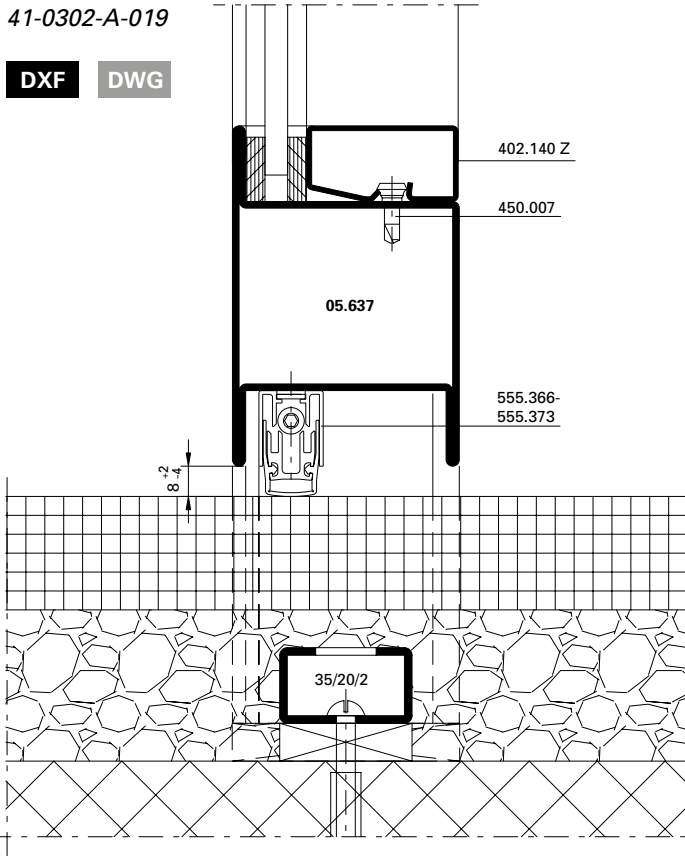

41-0302-A-020

DXF DWG

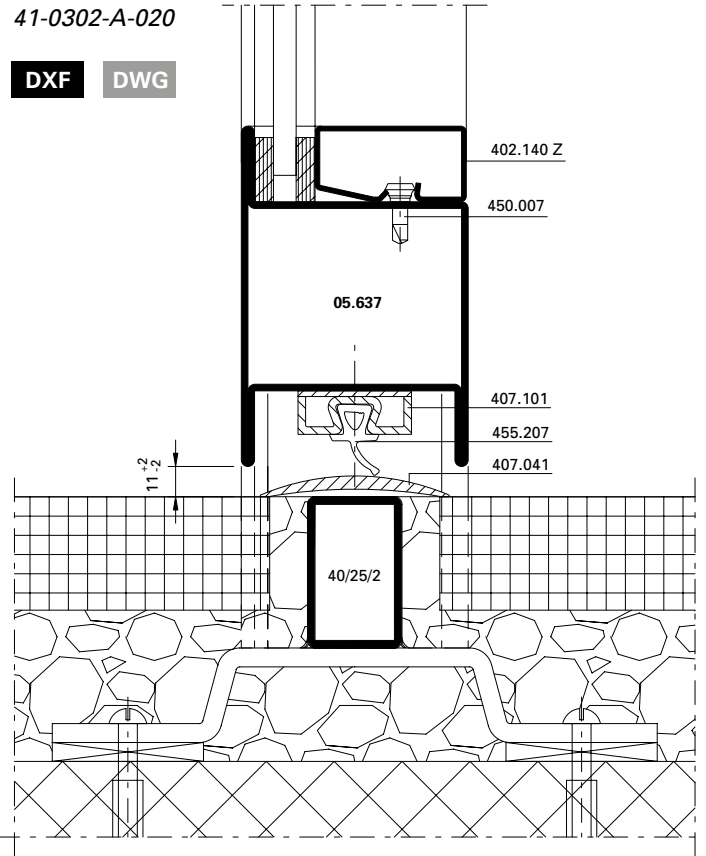

41-0302-A-021

DXF DWG

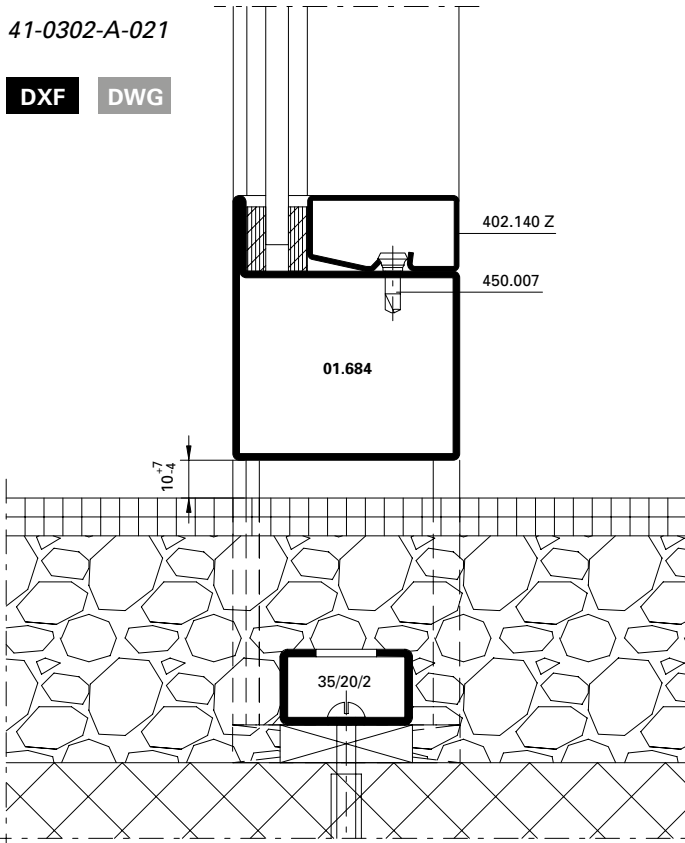

41-0302-A-022

DXF DWG

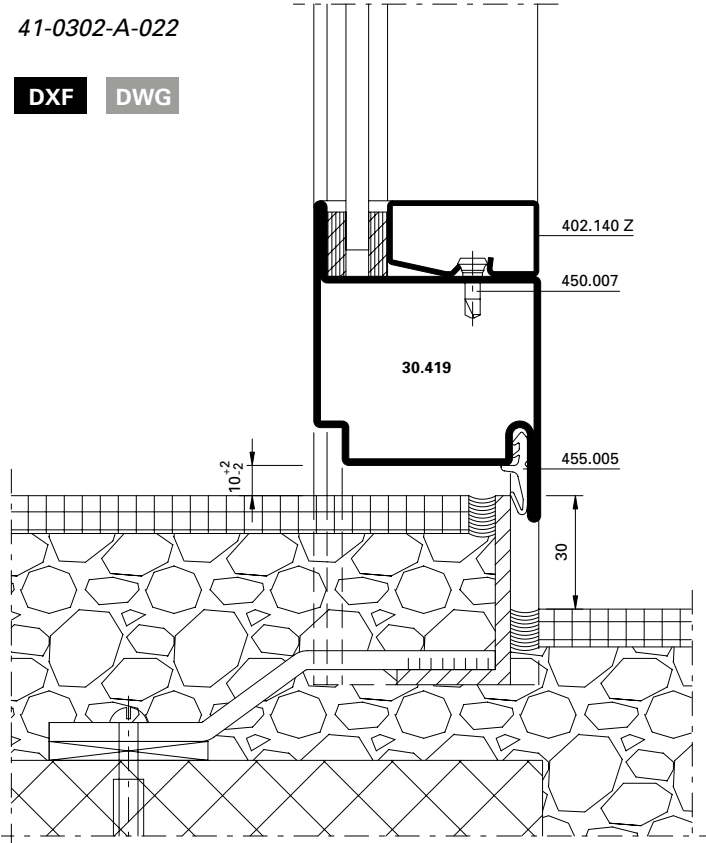

41-0302-A-023

DXF DWG

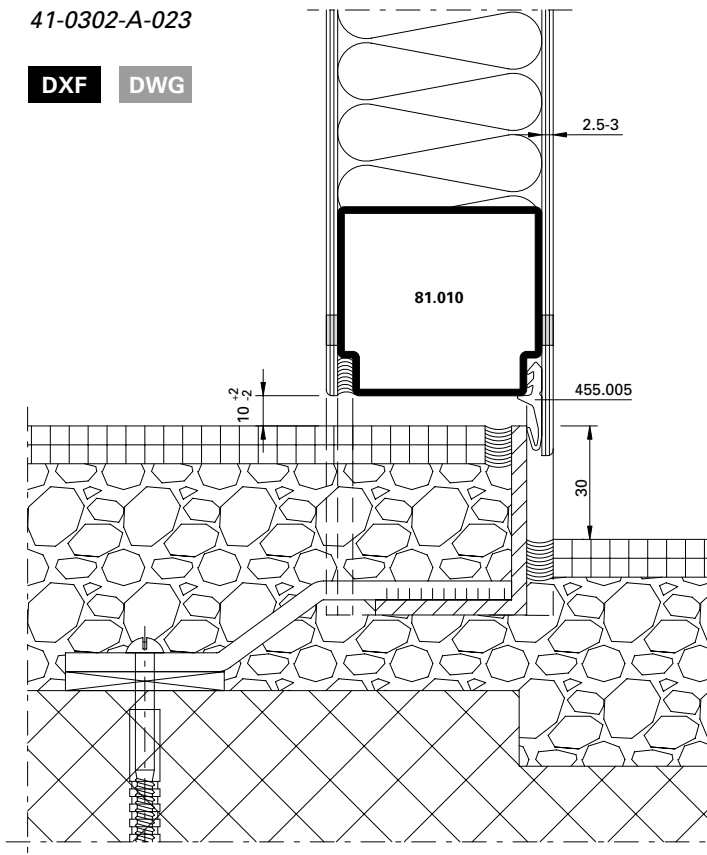

41-0302-A-024

DXF DWG

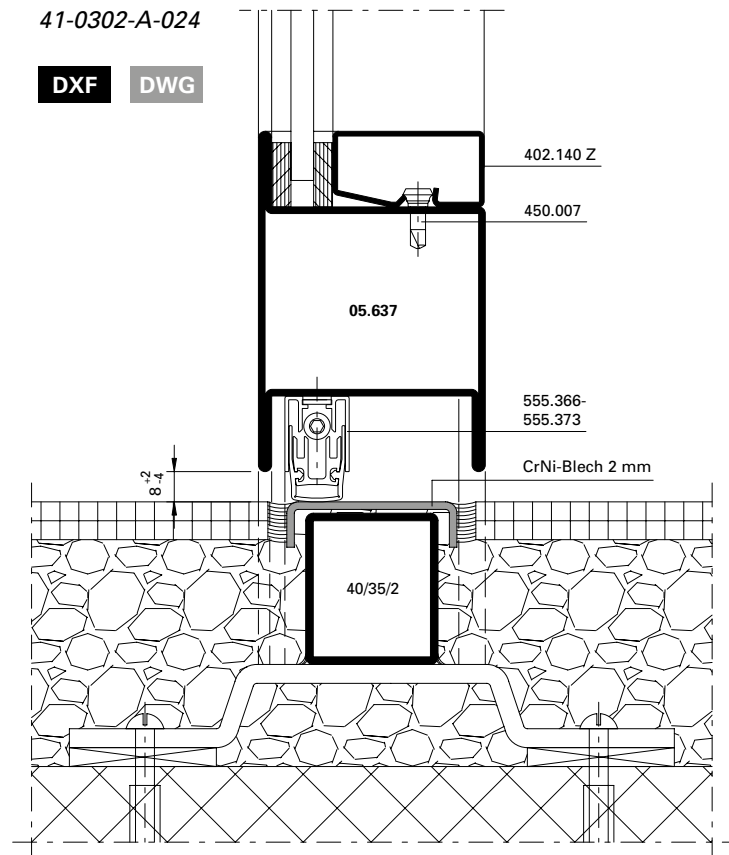

41-0302-A-025

DXF DWG

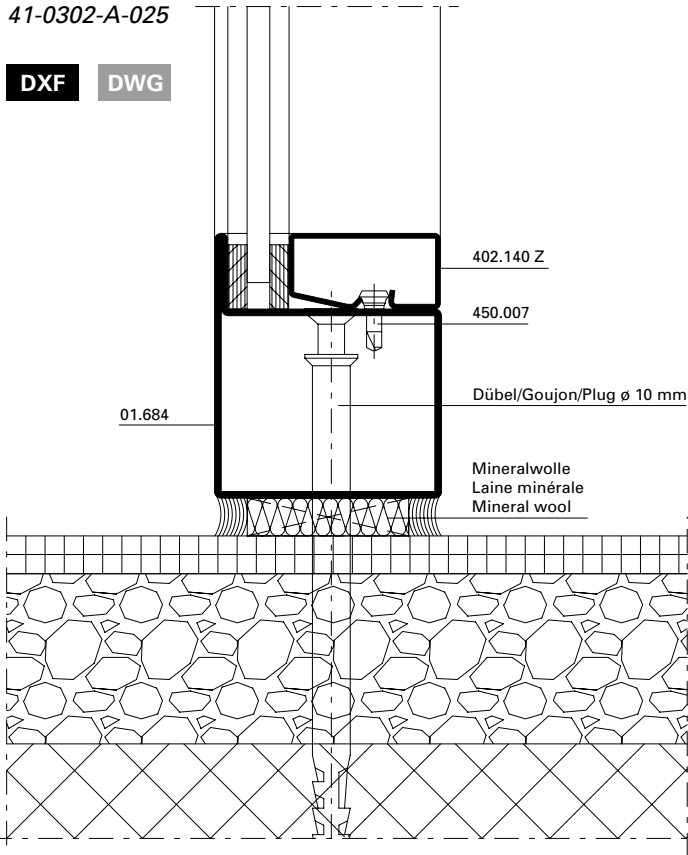

41-0302-A-027

DXF DWG

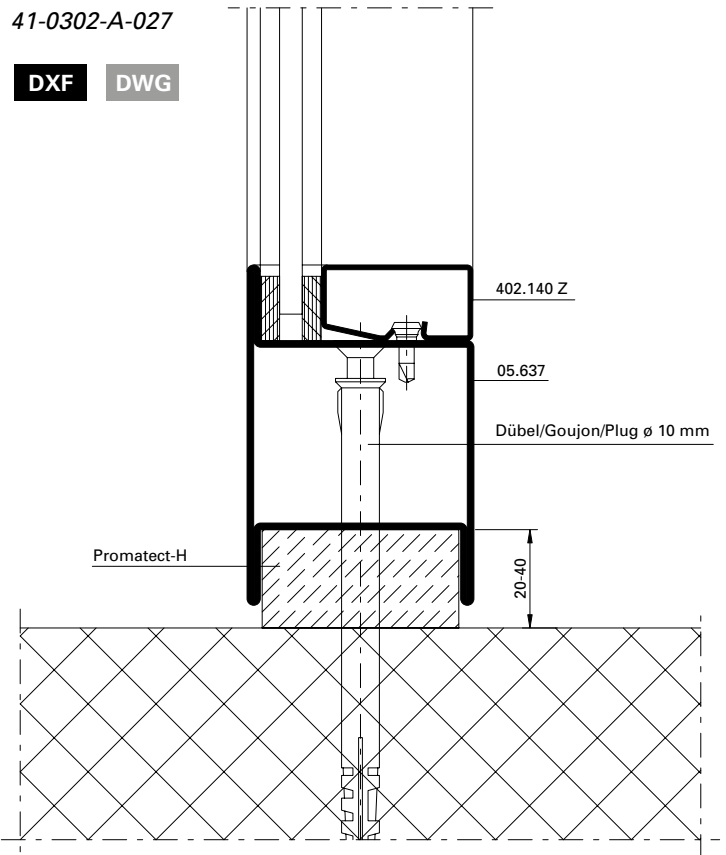

41-0302-A-026

DXF DWG

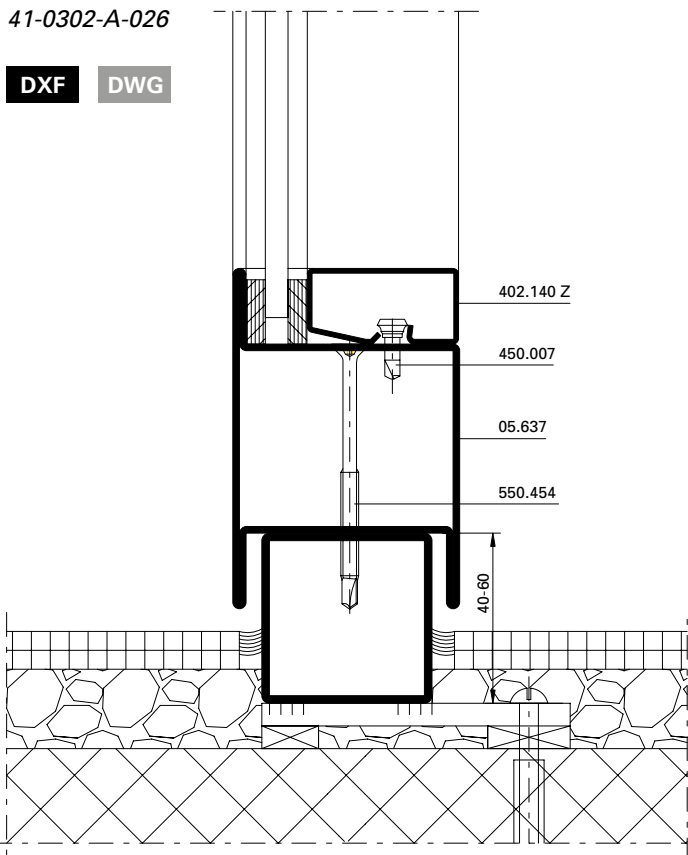

41-0302-A-028

DXF DWG

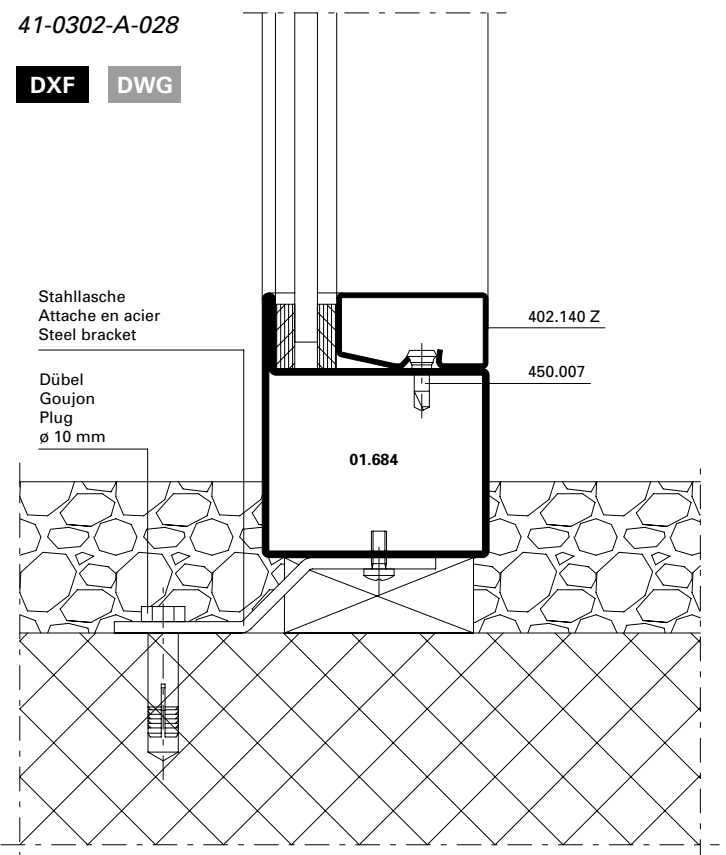

U_f-Werte
(nach EN ISO 10077-2:2018-01)

Auf den folgenden Seiten finden Sie die U_f-Werte für die verschiedenen Anwendungen von Jansen-Economy 60 E30.

Sie basieren auf folgenden Grundlagen:

Stahl

- Profile bandverzinkter Stahl, unbeschichtet
- Stahl-Glasleisten
- Trockenverglasung
- Nassverglasung

Valeurs U_f
(selon EN ISO 10077-2:2018-01)

Vous trouverez les valeurs U_f pour les différentes applications Jansen-Economy 60 E30 dans les pages qui suivent.

Elles se basent sur les principes suivants:

Acier

- Profilés en bande d'acier zingué, sans revêtement
- Parcloses en acier
- Vitrage à sec
- Vitrage à mastic

U_f values
(according to
EN ISO 10077-2:2018-01)

On the following pages you will find the U_f values for the various applications for Jansen-Economy 60 E30.

They are based on the following:

Steel

- Strip galvanised steel profiles, uncoated
- Steel glazing beads
- Glazing with dry glazing
- Glazing with sealing

U_f-Werte
 (nach EN ISO 10077-2:2018-01)

Valeurs U_f
 (selon EN ISO 10077-2:2018-01)

U_f values
 (according to EN ISO 10077-2:2018-01)

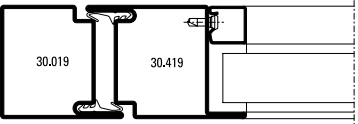
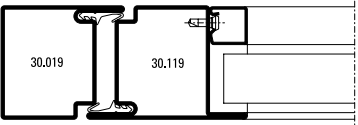
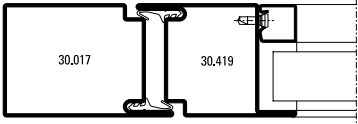
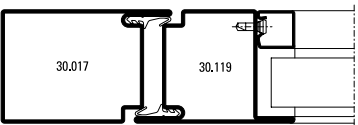
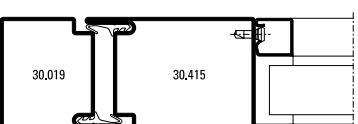
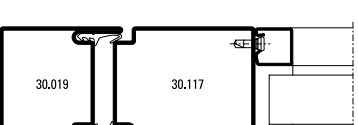
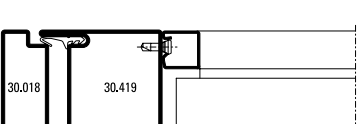
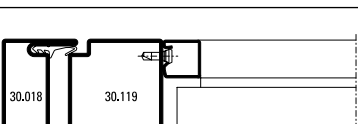
|  | Füllelementstärken Elements de remplissages Infill elements > 24 mm |
|--|--|
|  | 5,5 W/m²K |
|  | 5,6 W/m²K |
|  | 5,3 W/m²K |
|  | 5,3 W/m²K |
|  | 5,3 W/m²K |
|  | 5,3 W/m²K |
|  | 5,6 W/m²K |
|  | 5,7 W/m²K |

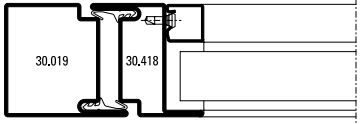
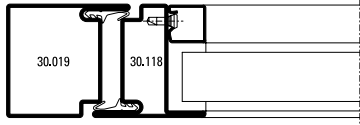
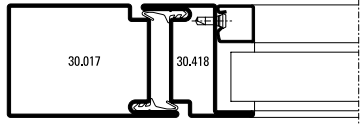
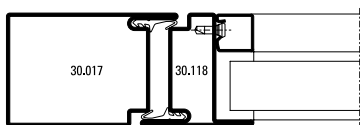
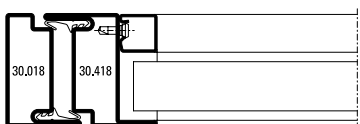
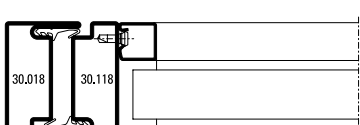
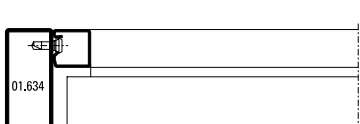
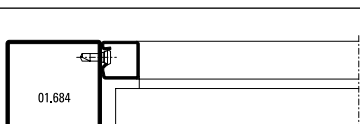
|  | Füllelementstärken Elements de remplissages Infill elements > 24 mm |
|--|--|
|  | 5,7 W/m²K |
|  | 5,8 W/m²K |
|  | 5,5 W/m²K |
|  | 5,5 W/m²K |
|  | 6,0 W/m²K |
|  | 6,1 W/m²K |
|  | 6,9 W/m²K |
|  | 6,1 W/m²K |

U_f-Werte
 (nach EN ISO 10077-2:2018-01)

Valeurs U_f
 (selon EN ISO 10077-2:2018-01)

U_f values
 (according to EN ISO 10077-2:2018-01)

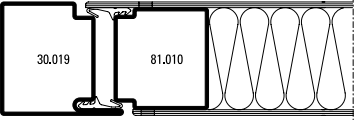
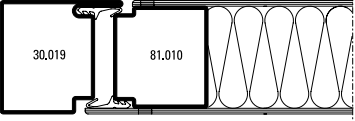
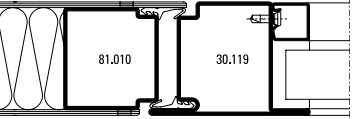
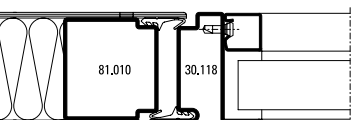
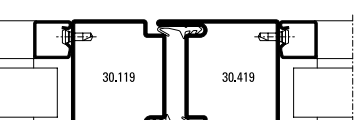
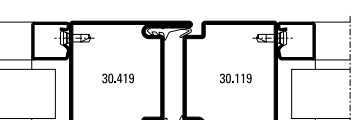
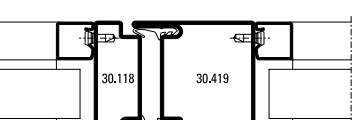
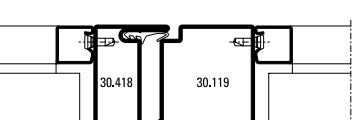
|  | Füllelementstärken Elements de remplissages Infill elements > 24 mm |
|---|--|
|  | 5,3 W/m²K |
|  | 5,3 W/m²K |
|  | 5,7 W/m²K |
|  | 6,0 W/m²K |
|  | 5,8 W/m²K |
|  | 5,8 W/m²K |
|  | 6,1 W/m²K |
|  | 6,1 W/m²K |

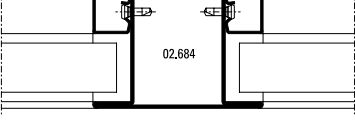
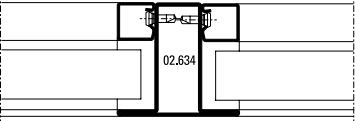
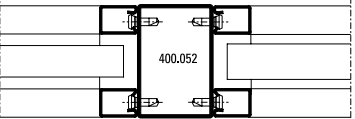
|  | Füllelementstärken Elements de remplissages Infill elements > 24 mm |
|---|--|
|  | 6,3 W/m²K |
|  | 7,2 W/m²K |
|  | 6,4 W/m²K* |

- * Nassverglasung
- * Vitrage à mastic
- * Glazing with sealing

U_f-Werte
 (nach EN ISO 10077-2:2018-01)

Valeurs U_f
 (selon EN ISO 10077-2:2018-01)

U_f values
 (according to EN ISO 10077-2:2018-01)

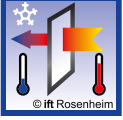
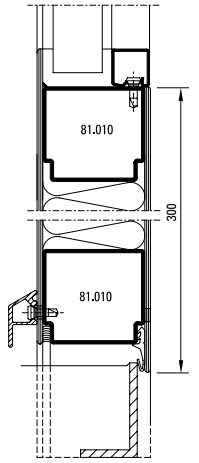
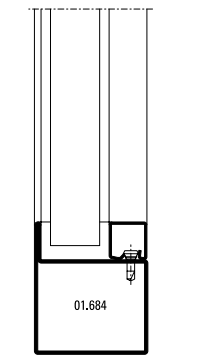
|  <p>Füllelementstärken Elements de remplissages Infill elements</p> <p>> 24 mm</p> | |
|---|-----------------------------|
|  | <p>4,4 W/m²K</p> |
|  | <p>6,1 W/m²K</p> |

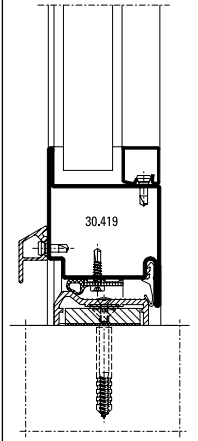
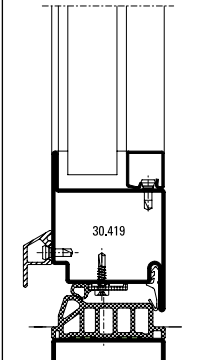
|  <p>Füllelementstärken Elements de remplissages Infill elements</p> <p>> 24 mm</p> | |
|--|-----------------------------|
|  | <p>6,1 W/m²K</p> |
|  | <p>5,6 W/m²K</p> |

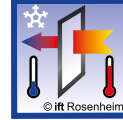
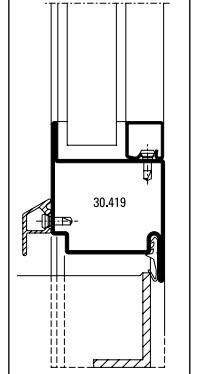
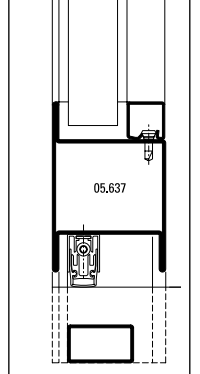
|  <p>Füllelementstärken Elements de remplissages Infill elements</p> <p>> 24 mm</p> | |
|--|-----------------------------|
|  | <p>6,8 W/m²K</p> |
|  | <p>5,6 W/m²K</p> |