

Jansen-Economy 50 E30/EW30/E60/EW60

Brandschutz-Türen und -Verglasungen aus Stahl und Edelstahl

Jansen-Economy 50 E30/EW30/E60/EW60

Portes et cloisons protection incendie en acier et acier Inox

Jansen-Economy 50 E30/EW30/E60/EW60

Fire resistant doors and screens in steel and stainless steel

Systemübersicht

Merkmale
Zulassungen
Systemausführungen
Typenübersicht

Sommaire du système

Caractéristiques
Homologations
Exécutions de système
Sommaire des types

Summary of system

Characteristics
Authorisations
System versions
Summary of types

2

Profilsortiment in Stahl und Edelstahl

Assortiment de profilé en acier et acier inox

Range of profiles in steel and stainless steel

11

Beispiele

Schnittpunkte
Konstruktionsdetails
Anschlüsse am Bau

Exemples

Coupes de détails
Détails de construction
Raccords au mur

Examples

Section details
Construction details
Attachment to structure

16

Leistungseigenschaften

Caractéristiques de performance

Performance characteristics

34

Alle Ausführungen dieser Dokumentation haben wir sorgfältig und nach bestem Wissen zusammengestellt. Wir können aber keine Verantwortung für die Benutzung der vermittelten Vorschläge und Daten übernehmen. Wir behalten uns technische Änderungen ohne Vorankündigung vor.
Aktuelle Version auf www.jansen.com

Nous avons apporté le plus grand soin à l'élaboration de cette documentation. Cependant, nous déclinons toute responsabilité pour l'utilisation faite de nos propositions et de nos données.
Nous nous réservons le droit de procéder à des modifications techniques sans préavis.
Version actuelle sur www.jansen.com

All the information contained in this documentation is given to the best of our knowledge and ability. However, we decline all responsibility for the use made of these suggestions and data.
We reserve the right to effect technical modifications without prior warning.
Current version available at www.jansen.com





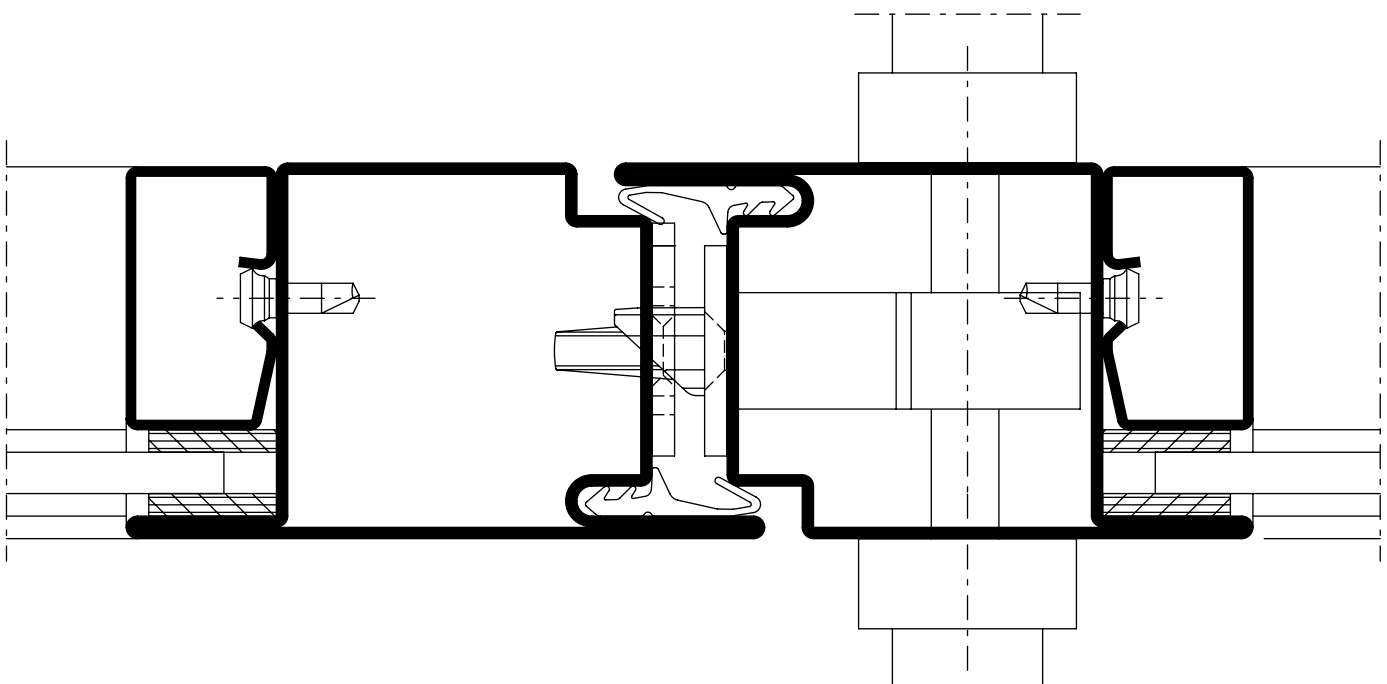

Merkmale
Caractéristiques
Characteristics

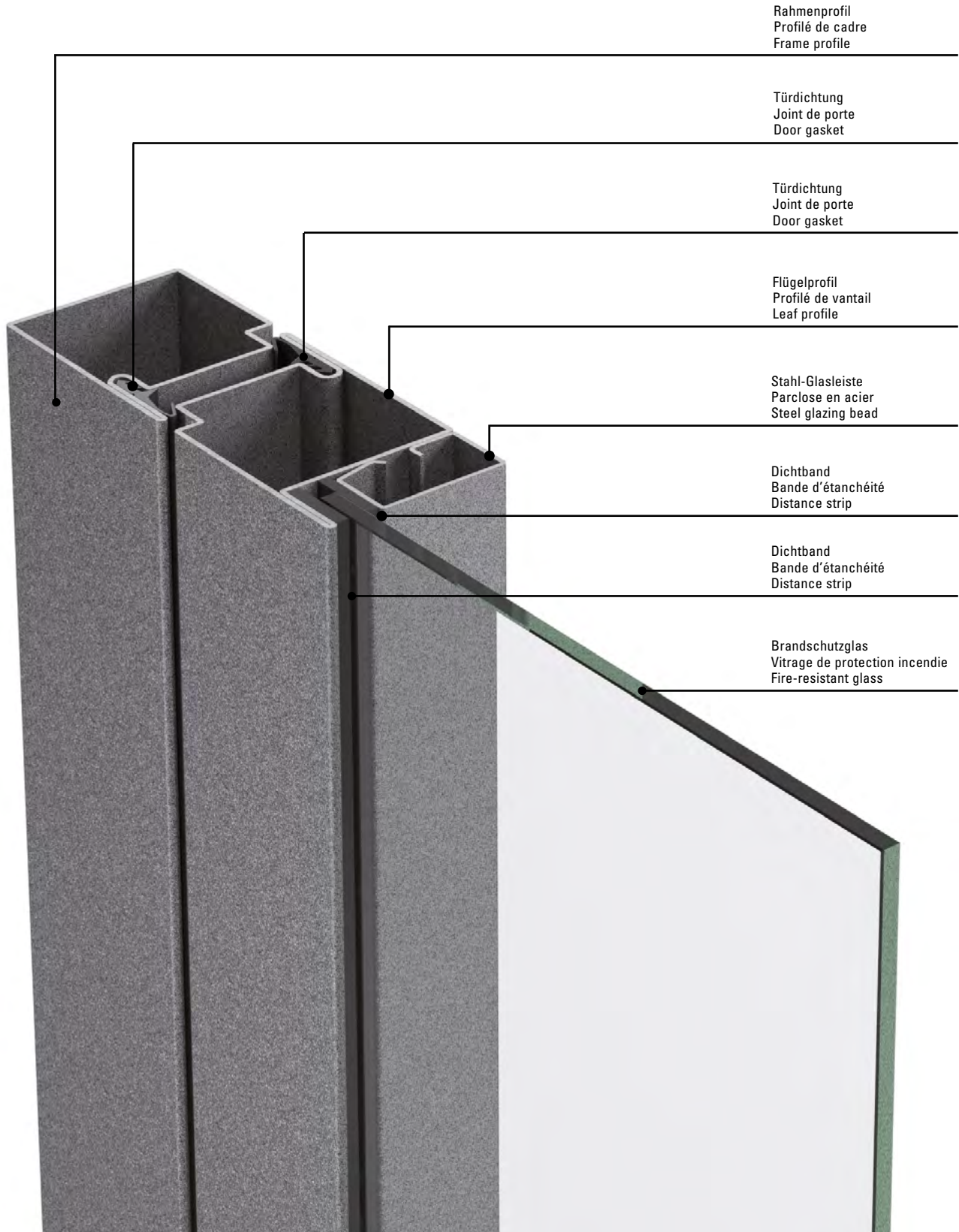
Jansen-Economy 50 E30
Jansen-Economy 50 E30
Jansen-Economy 50 E30

- Stahlsystem für Türen und Festverglasungen
- Bautiefe 50 mm, innen und aussen flächenbündig
- Schmale Ansichtsbreiten: Rahmen und Flügel ab 107,5 mm Stulppartie 155 mm
- Ein- und zweiflüglige Türen, nach innen und aussen öffnend, mit oder ohne Seitenteile und Oberlichter sowie Trennwände
- Türflügel bis 1750 x 3750 mm (BxH), landesspezifische Zulassung beachten
- Füllelementstärke von 5 bis 27 mm, Glaseinbau mittels Trocken- oder Nassverglasung
- Systemprüfungen nach EN 16034 und Produktnorm EN 14351-1
- Stahlprofile blank oder bandverzinkt
- Grosses Sortiment an systemgeprüften Türbeschlägen
- Barrierefreie Schwellenausbildungen
- Geeignet für Pulver- und Nasslackbeschichtungen
- Système en acier pour portes et vitrages fixes
- Profondeur de montage 50 mm, montage à fleur à l'intérieur et à l'extérieur
- Fines largeurs de face: Cadre et vantaux à partir de 107,5 mm Partie tête 155 mm
- Portes à un et deux vantaux, ouverture vers l'intérieur et vers l'extérieur, combinables avec parties latérales, impostes et vitrage fixe
- Vantaux de porte jusqu'à 1750 x 3750 mm (LaxH), il convient de respecter les prescriptions et règlements des divers pays concernés
- Élément de remplissage de 5 à 27 mm d'épaisseur, Montage du vitrage à sec ou à silicone
- Contrôles des systèmes selon EN 16034 et la norme produit EN 14351-1
- Profilés en acier brut ou galvanisé en continu
- Grand assortiment de ferrures de porte homologuées
- Formes de seuil sans barrière
- Convient aux revêtements par poudre ou peinture liquide
- Steel system for doors and fixed glazing
- 50 mm basic depth, flush-fitted on the inside and outside
- Narrow face widths: Frame and leaf from 107.5 mm Meeting stile assembly 155 mm
- Single and double-leaf doors, inward and outward-opening, can be combined with side-lights, toplight or fixed glazing
- Door leaf up to 1750 x 3750 mm (WxH), the regulations and bye-laws in force in the particular country must be respected
- Infill unit thickness of 5 to 27 mm, Glazing installed by means of dry or wet glazing
- System tests in accordance with EN 16034 and EN 14351-1
- Raw finish or strip galvanised steel profiles
- Large range of system-tested door fittings
- Easy-access thresholds
- Suitable for powder and wet paint coating





Norm	Eigenschaft Caractéristique Characteristic	Klassifizierung/Wert Classification / Valeur Classification / Value									
 EN ISO 10077-2	Wärmedurchgangskoeffizient U_f (W/(m²·K)) Transmission thermique U_f (W/(m²·K)) Thermal production U_f (W/(m²·K))	npd	ab 5.65 W/m ² K à partir de 5.65 W/m ² K from 5.65 W/m ² K								
 EN 1191 EN 1603	Dauerfunktionsprüfung Durabilité mécanique Mechanical durability	D	1 5'000	2 10'000	3 20'000	4 50'000	5 100'000	6 200'000	7 500'000	8 1'000'000	
 EN 179 EN 1125	Fähigkeit zur Freigabe Capacité au déclenchement Ability to release	Anforderung erfüllt Exigence remplie Requirement fulfilled									
 EN 1634-1 EN 13501-2	Brandschutz Résistance aux feu Fire resistance	E30 / EW30 / E60 / EW60									
 EN 16034 EN 13501-2	Selbstschliessung Fermeture automatique Self-closing	C									
 EN 16034	Dauerhaftigkeit der Selbstschliessung gegenüber Alterung (Korrosion) Endurance de la fermeture automatique contre le vieillissement (corrosion) Durability of self-closing against ageing (corrosion)	erzielt atteinte achieved									



Fluchttürsysteme

- Fluchttürsysteme geeignet für Notausgänge und Paniktüren
- Fluchttürnorm EN 179 für Notausgangsverschlüsse erfüllt
- Fluchttürnorm EN 1125 für Panikverschlüsse erfüllt

Systèmes de porte de secours

- Systèmes de porte de secours pour issues de secours et portes panique
- Norme relative aux portes de secours EN 179, remplie pour les fermetures d'issue de secours
- Norme relative aux portes de secours EN 1125, remplie pour les fermetures panique

Emergency exit systems

- Emergency exit systems suitable for emergency exits and panic doors
- Emergency exit standard EN 179 for emergency exit devices fulfilled
- Emergency exit standard EN 1125 for panic exit devices fulfilled



Jansen-Economy 50 E30 / EW30 / E60 / EW60 Edelstahl

- Werkstoff 1.4307 und 1.4404
- Für ein- und zweiflüglige Brandschutztüren mit oder ohne Seitenteile bzw. Oberlicht
- Für Brandschutztrennwände
- Für Aussenanwendungen
- Schlanke Rahmen und Türprofile mit nur 50 mm Bautiefe

Jansen-Economy 50 E30 / EW30 / E60 / EW60 acier inox

- Matériaux 1.4307 et 1.4404
- Pour portes coupe-feu à un/deux vantaux avec ou sans pièces latérales ou imposte
- Pour cloisons coupe-feu
- Pour l'extérieur
- Cadres et profilés de porte fins avec une profondeur d'encastrement de seulement 50 mm

Jansen Economy 50 E30 / EW30 / E60 / EW60 stainless steel

- Material 1.4307 and 1.4404
- For single and double-leaf fire doors with or without sidelight/toplight
- For fire walls
- For external use
- Narrow frames and door profiles with just 50 mm basic depth

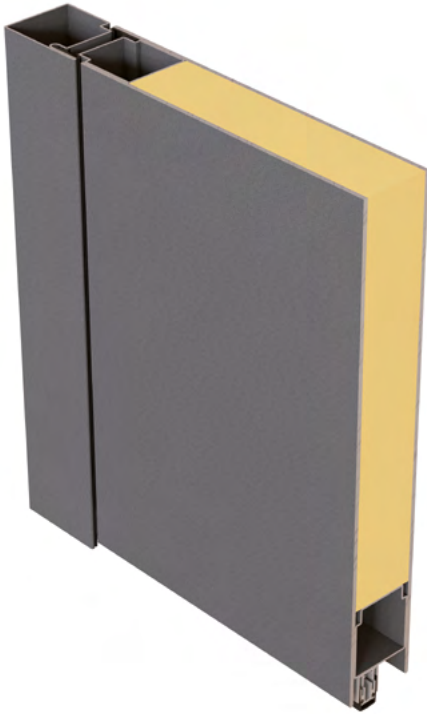

Verblechte Jansen-Economy 50 E30 Türen

- Für ein- und zweiflügelige Brandschutztüren mit oder ohne Seitenteile resp. Oberlichter
- Flächenbündig verblechte Türen
- Bleche können an den Rahmen geschweisst oder geklebt werden
- Mit oder ohne Glasausschnitte möglich

Portes tôlées Jansen-Economy 50 E30

- Pour des portes coupe-feu à un/deux vantaux avec ou sans pièces latérales ou impostes
- Portes tôlées à fleur
- Les tôles peuvent être soudées ou collées sur le cadre
- Possibles avec ou sans panneaux de verre

Jansen Economy 50 E30 sheet metal doors

- For single and double-leaf fire doors with or without sidelights or toplights
- Flush-fitted sheet metal doors
- Sheet metal can be welded or bonded to the frame
- Possible with or without glass vision panels

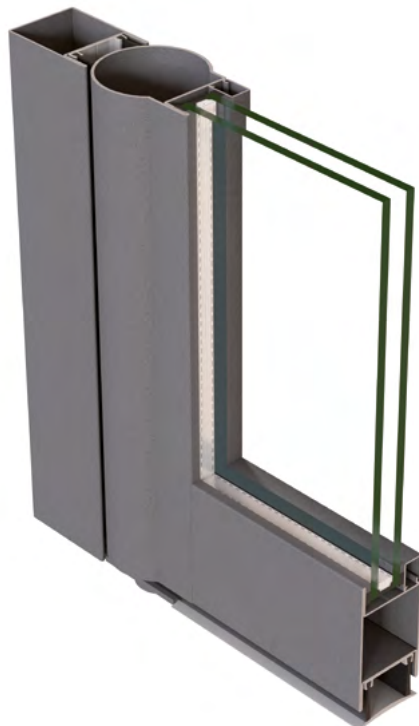

Jansen-Economy 50 E30 / EW30 / E60 / EW60 Fingerschutztüren

- Keine Quetsch- und Scherstellen nach DIN 18650
- Wartungsarme Bandlager unten und oben
- Geeignet für Gebäude mit starkem Publikumsverkehr
- Geprüft nach EN 14351-1

Portes anti-pince-doigts

Jansen-Economy 50 E30 / EW30 / E60 / EW60

- Absence de zones d'écrasement et de cisaillement selon DIN 18650
- Paliers de paumelle inférieur et supérieur exigeant peu de maintenance
- Adapté à des bâtiments publics fortement fréquentés
- Contrôlé selon la norme EN 14351-1

Jansen Economy 50 E30 / EW30 / E60 / EW60 anti-finger-trap doors

- No crushing and shearing points as per DIN 18650
- Low-maintenance hinge bush at top and bottom
- Suitable for buildings subject to frequent use by the public
- Tested in accordance with EN 14351-1

Jansen Docu Center

Die Plattform zum effizienten Arbeiten mit Jansen Dokumentationen. Im Jansen Docu Center stehen alle Produktinformationen jederzeit digital in der aktuellsten Version zur Verfügung: von Architekten-Informationen über Bestell- und Fertigungskatalogen bis hin zu Anleitungen und Prospekten sowie Videos.

Die Inhalte können einfach und schnell aufgerufen werden. Ein für den Anwender komfortables papierloses Arbeiten, das zahlreiche Vorteile bietet.

Jansen Docu Center

La plate-forme pour travailler efficacement avec les documentations Jansen. Le Jansen Docu Center met à votre disposition les informations sur les produits, en format numérique et dans une version actualisée: des catalogues de commande et de fabrication aux instructions et prospectus, en passant par les informations destinées aux architectes et vidéos.

Les contenus sont facilement et rapidement accessibles. Une manière de travailler confortable et offrant de nombreux avantages.

Jansen Docu Center

The platform for working efficiently with Jansen documentation. The latest version of all the product information is available digitally at any time in the Jansen Docu Center – from order and fabrication manuals to architect information, instructions and brochures and videos.

The content can be retrieved quickly and easily. The user can work conveniently without paper, which has numerous benefits.

Download CAD Daten

DXF

DWG

Sie können die Zeichnungen in den Formaten DXF und/oder DWG herunterladen. Klicken Sie auf das entsprechende Icon und der Download erfolgt.

Die Hinweise «Artikelbibliothek/Türbeschläge/Fensterbeschläge» bedeuten, dass Sie mit einem Klick die gesamte Artikelbibliothek des entsprechenden Systems herunterladen (Profile, Beschläge, Glasleisten, Zubehör etc.).

Info und Beratung

Gerne beraten wir Sie persönlich und stehen Ihnen bei Fragen zur Verfügung. Bitte schreiben Sie uns Ihre Anliegen an: info@jansen.com

Télécharger fichiers DAO

DXF

DWG

Vous pouvez télécharger les dessins aux formats DXF et/ou DWG. Cliquez sur l'icône correspondante et le téléchargement s'effectuera.

Les indications «Bibliothèque des articles/Ferures de porte/Ferrures de fenêtres» signifie que vous téléchargez la totalité de la bibliothèque des articles du système donné (profilés, ferrures, parclozes, accessoires etc.).

Info et conseils

Nous vous conseillerons volontiers individuellement et sommes à votre disposition si vous avez des questions à poser. Veuillez nous envoyer votre requête à: info@jansen.com

Download CAD files

DXF

DWG

You can download the drawings in DXF and/or DWG format. Click on the relevant icon to begin the download.

The items «Article library/Door fittings/Window fittings» means that you download the entire article library for the corresponding system with one click (profiles, fittings, glazing beads, accessories etc.).

Information and advice

We would be delighted to provide you with advice in person and are available to answer any questions you may have. Please write to us with your queries at: info@jansen.com

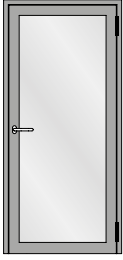

Einflügelige Türe
Porte à un vantail
Single leaf door

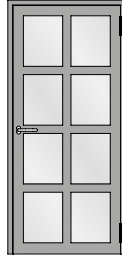

Einflügelige Türe mit Riegel
Porte à un vantail avec traverse
Single leaf door with transom

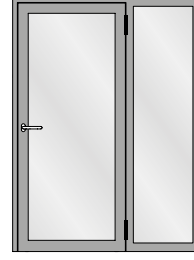

Einflügelige Türe mit festem Seitenteil
Porte à un vantail avec partie latérale fixe
Single leaf door with fixed side light

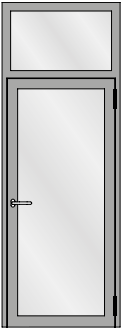

Einflügelige Türe mit festem Oberlicht
Porte à un vantail avec imposte fixe
Single leaf door with fixed top light

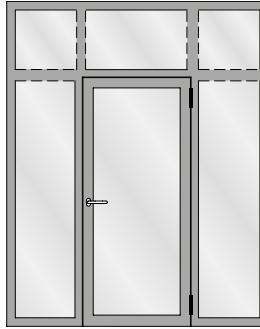

Einflügelige Türe mit zwei festen Seitenteilen
und festem Oberlicht
Porte à un vantail avec deux parties latérale fixe
et imposte fixe
Single leaf door with two fixed side light and
fixed top light

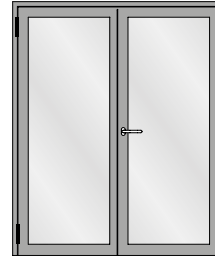

Zweiflügelige Türe
Porte à deux vantaux
Double leaf door



Zweiflügelige Türe mit zwei festen Seitenteilen
Porte à deux vantaux avec deux parties
latérales fixes
Double leaf door with two fixed side lights

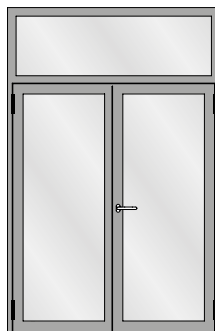

Zweiflügelige Türe mit festem Oberlicht
Porte à deux vantaux avec imposte fixe
Double leaf door with fixed top light

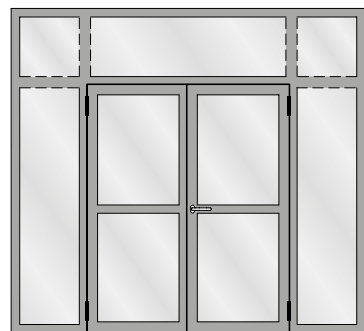

Zweiflügelige Türe mit zwei festen Seitenteilen
und festen Oberlichtern
Porte à deux vantaux avec deux parties latérales
fixes et impostes fixes
Double leaf door with two fixed side lights and
fixed top lights

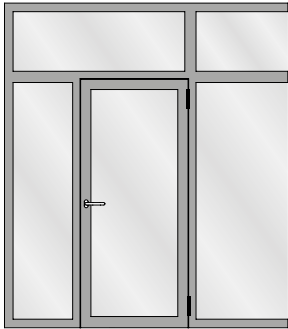

Festverglasung mit einflügeliger Türe
Vitrage fixe avec porte à un vantail
Fixed glazing with single leaf door

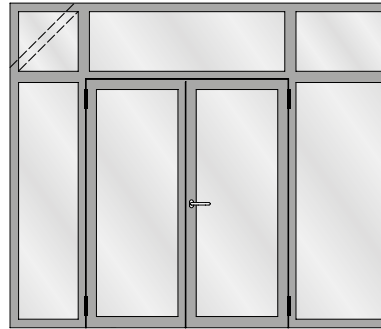

Festverglasung mit zweiflügeliger Türe
Vitrage fixe avec porte à deux vantaux
Fixed glazing with double leaf door

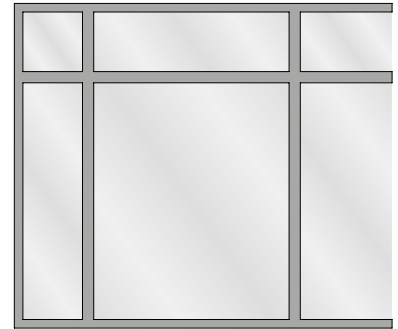

Festverglasung
Vitrage fixe
Fixed glazing

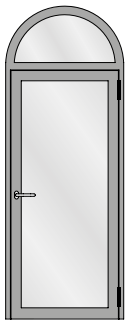

Einflügelige Türe mit Rundbogen-Oberlicht
Porte à un vantail avec imposte demi-ronde
Single leaf door with round arched top light

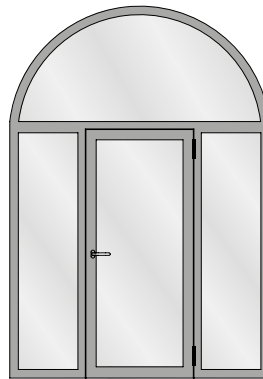

Einflügelige Türe mit zwei festen Seitenteilen
und Rundbogen-Oberlicht
Porte à un vantail avec deux parties latérales
fixes et imposte demi-ronde
Single leaf door with two fixed side lights and
round arched top light

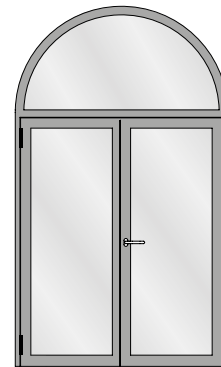

Zweiflügelige Türe mit Rundbogen-Oberlicht
Porte à deux vantaux avec imposte demi-ronde
Double leaf door with round arched top light

**Für Festverglasungen gelten
nationale Zulassungen.**

**Les homologations nationales
s'appliquent aux vitrages fixes.**

**National approvals apply to fixed
glazing.**

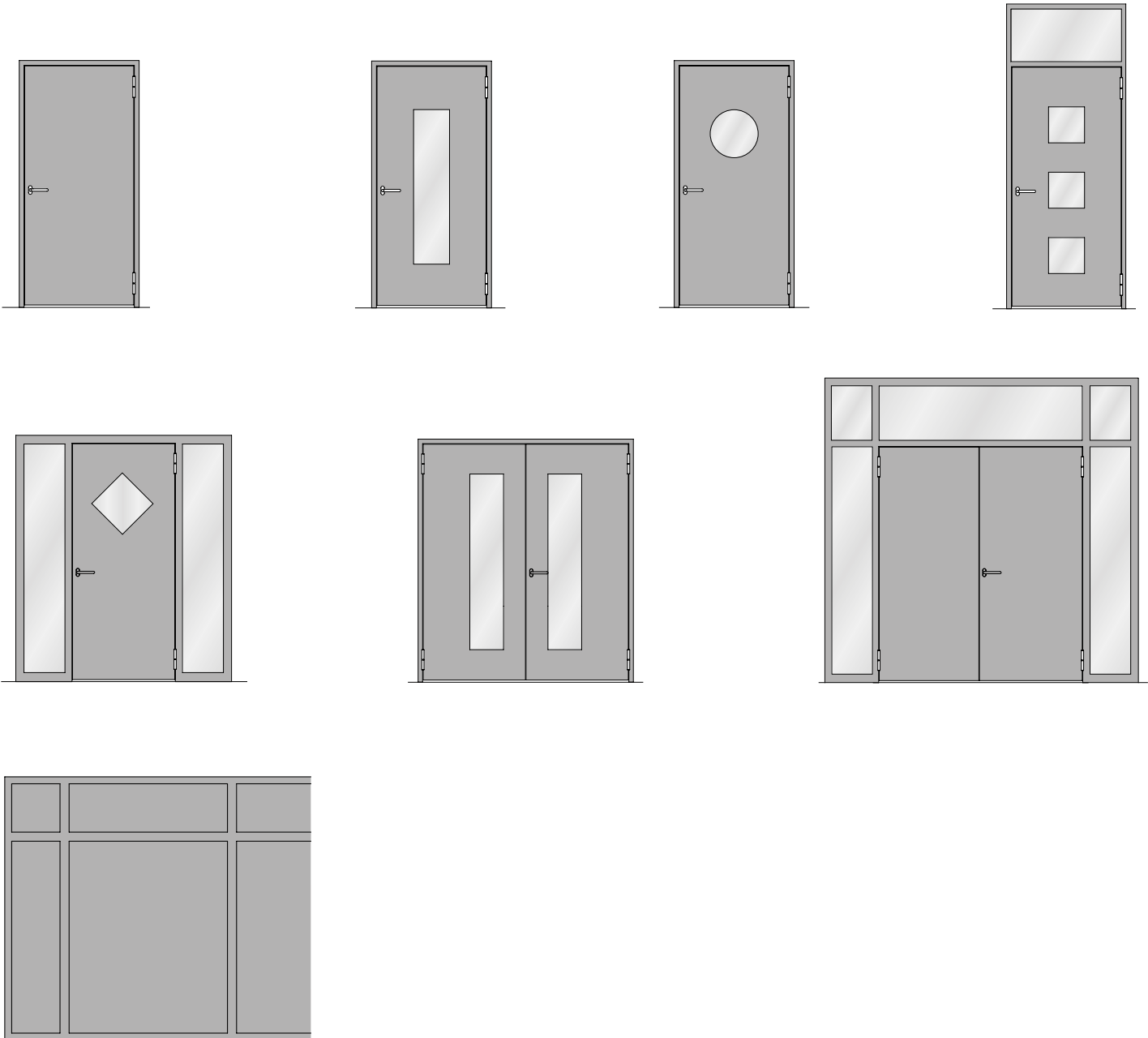

Für Festverglasungen gelten nationale Zulassungen.

Les homologations nationales s'appliquent aux vitrages fixes.

National approvals apply to fixed glazing.

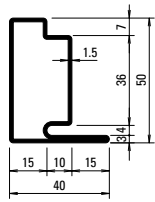

30.006
30.006 Z
 30.006.01
 30.006.05

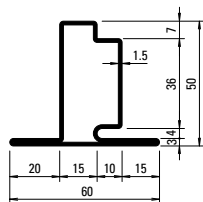

30.106
30.106 Z

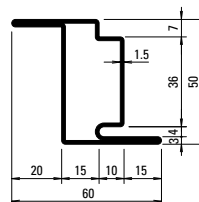

30.406
30.406 Z

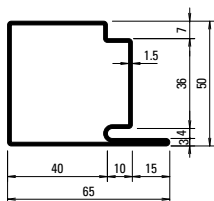

30.007
30.007 Z
 30.007.01
 30.007.05

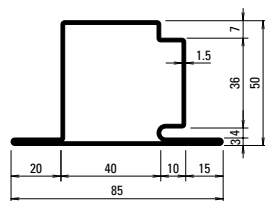

30.107
30.107 Z
 30.107.01
 30.107.05

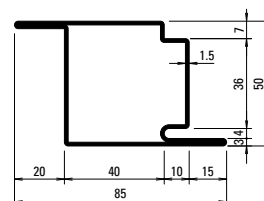

30.407
30.407 Z
 30.407.01
 30.407.05

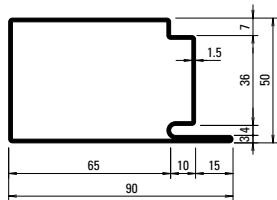

30.008
30.008 Z

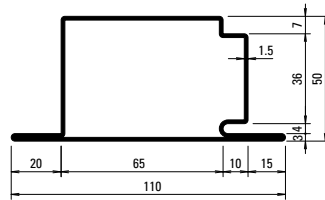

30.108
30.108 Z

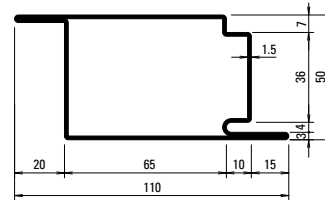

30.408
30.408 Z

Gewichte für die Edelstahl-Profile siehe Seite 13
 Poids pour profilés en acier Inox voir page 13
 Weights for stainless steel profiles see page 13

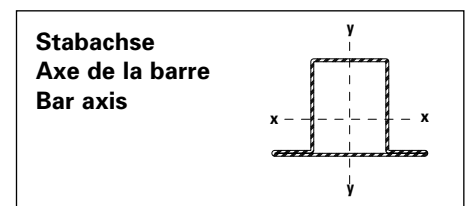

Profil-Nr.	G kg/m	F cm ²	I _x cm ⁴	W _x cm ³	I _y cm ⁴	W _y cm ³	U m ² /m
30.006	2,330	2,97	9,31	3,00	3,96	1,62	0,190
30.106	2,830	3,60	10,87	3,19	7,52	2,41	0,230
30.406	2,830	3,60	13,79	5,31	7,52	2,41	0,230
30.007	2,960	3,77	14,23	4,78	16,30	4,64	0,240
30.107	3,450	4,40	16,09	4,97	24,97	5,64	0,280
30.407	3,450	4,40	18,48	7,16	24,97	5,64	0,280

Profil-Nr.	G kg/m	F cm ²	I _x cm ⁴	W _x cm ³	I _y cm ⁴	W _y cm ³	U m ² /m
30.008	3,590	4,57	19,06	6,59	40,34	8,68	0,290
30.108	4,080	5,20	21,15	6,76	56,20	9,84	0,330
30.408	4,080	5,20	23,17	9,02	56,20	9,84	0,330

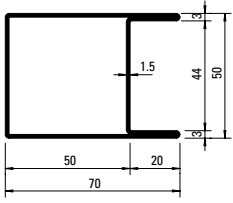

04.568
04.568 Z

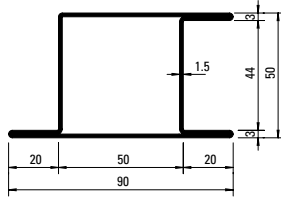

05.568
05.568 Z
 05.568.01
 05.568.05

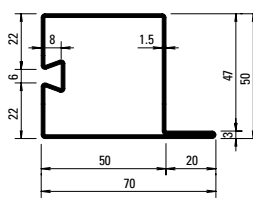

32.388
32.388 Z

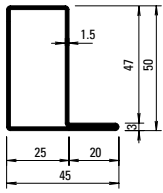

01.534
01.534 Z
 01.534.01
 01.534.05

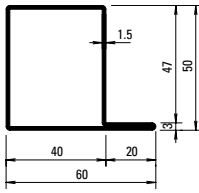

01.564
01.564 Z
 01.564.01
 01.564.05

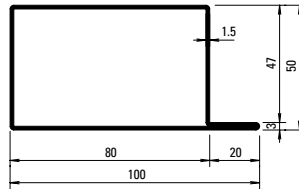

01.592
01.592 Z

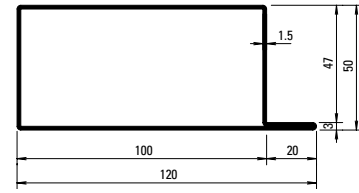

01.596
01.596 Z

Oberfläche/Werkstoff

Artikel-Nr.

ohne Zusatz = blank

mit Z = bandverzinkter Stahl

Werkstoff 1.4404 (AISI 316L)

mit 01 = blank

mit 03 = geschliffen, Korn 220-240

Werkstoff 1.4307 (AISI 304L)

mit 05 = blank

mit 07 = geschliffen, Korn 220-240

Edelstahl geschliffen auf Anfrage

Surface/Matériau

No. d'article

sans supplément = brut

avec Z = bande d'acier zinguée

Matériau 1.4404 (AISI 316L)

avec 01 = brut

avec 03 = polies, grain 220-240

Matériau 1.4307 (AISI 304L)

avec 05 = brut

avec 07 = polies, grain 220-240

Acier Inox polie sur demande

Surface/Material

Part no.

without addition = bright

with Z = strip galvanised steel

Material 1.4404 (AISI 316L)

with 01 = bright

with 03 = polished, grain 220-240

Material 1.4307 (AISI 304L)

with 05 = bright

with 07 = polished, grain 220-240

Stainless steel polished on request

Profil-Nr.	G kg/m	F cm ²	I _x cm ⁴	W _x cm ³	I _y cm ⁴	W _y cm ³	U m ² /m
01.534	2,130	2,71	9,35	3,11	4,78	1,73	0,185
01.564	2,490	3,17	12,10	4,12	11,20	3,25	0,216
01.592	3,430	4,37	19,35	6,86	46,90	8,80	0,296
01.596	3,900	4,97	22,93	8,25	77,23	12,30	0,336

Profil-Nr.	G kg/m	F cm ²	I _x cm ⁴	W _x cm ³	I _y cm ⁴	W _y cm ³	U m ² /m
04.568	3,190	4,06	17,76	7,11	21,77	6,20	0,275
05.568	3,620	4,65	20,62	7,37	32,39	6,55	0,315
32.388	2,940	3,74	14,10	4,89	18,50	4,56	0,254

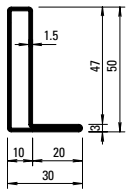

01.531
01.531 Z

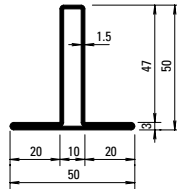

02.531
02.531 Z

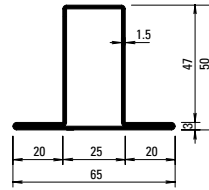

02.534
02.534 Z
 02.534.01
 02.534.05

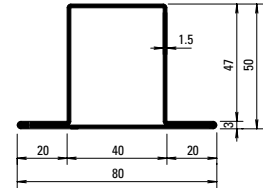

02.564
02.564 Z
 02.564.01
 02.564.05

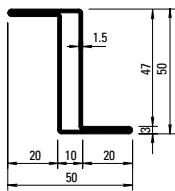

03.531
03.531 Z

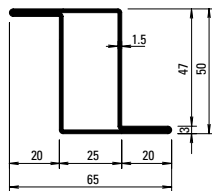

03.534
03.534 Z

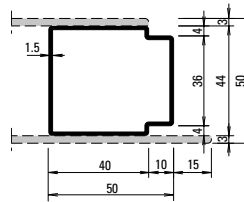

81.009
81.009 Z

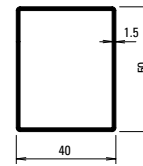

400.048
400.048 Z

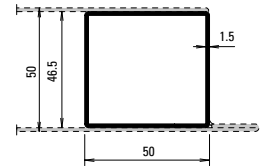

400.049
400.049 Z

Profil-Nr.	G kg/m	F cm ²	I _x cm ⁴	W _x cm ³	I _y cm ⁴	W _y cm ³	U m ² /m
01.531	1,770	2,26	6,55	2,11	1,42	0,67	0,155
02.531	2,240	2,86	8,00	2,31	3,26	1,30	0,195
02.534	2,590	3,30	10,99	3,30	8,56	2,63	0,224
03.531	2,240	2,85	10,63	4,25	3,25	1,30	0,194
02.564	2,950	3,75	13,90	4,31	17,60	4,40	0,255
03.534	2,590	3,30	13,28	5,13	8,56	2,63	0,224
81.009	2,090	2,67	7,79	3,54	9,63	3,76	0,182
400.048	2,050	2,58	9,46	3,78	6,70	3,35	0,177
400.049	2,200	2,77	10,61	4,24	9,49	4,08	0,190

Artikelbibliothek
 Bibliothèque des articles
 Article library

DXF **DWG**

Gewichte für Edelstahl-Profile

.01 = Werkstoff 1.4404 (AISI 316L)
 .05 = Werkstoff 1.4307 (AISI 304L)

30.006.01	=	2,232 kg/m
30.007.01	=	2,832 kg/m
30.107.01	=	3,288 kg/m
30.407.01	=	3,288 kg/m
01.534.01	=	2,153 kg/m
02.534.01	=	2,622 kg/m
01.564.01	=	2,513 kg/m
02.564.01	=	2,975 kg/m
05.568.01	=	3,672 kg/m

Poids pour profilés en acier Inox

.01 = matériau 1.4404 (AISI 316L)
 .05 = matériau 1.4307 (AISI 304L)

30.006.05	=	2,204 kg/m
30.007.05	=	2,797 kg/m
30.107.05	=	3,247 kg/m
30.407.05	=	3,247 kg/m
01.534.05	=	2,126 kg/m
02.534.05	=	2,589 kg/m
01.564.05	=	2,481 kg/m
02.564.05	=	2,938 kg/m
05.568.05	=	3,626 kg/m

Weights for stainless steel profiles

.01 = material 1.4404 (AISI 316L)
 .05 = material 1.4307 (AISI 304L)

Bogentüren
Portes cintrées
Arched doors

Jansen-Economy 50 E30
 Jansen-Economy 50 E30
 Jansen-Economy 50 E30

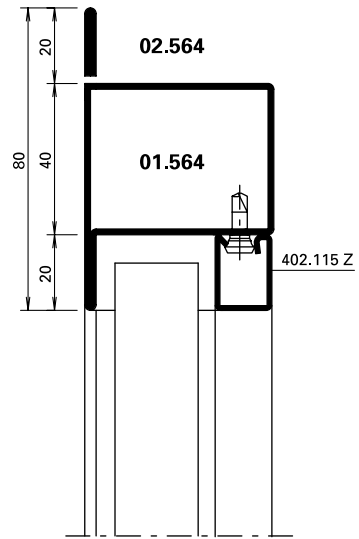
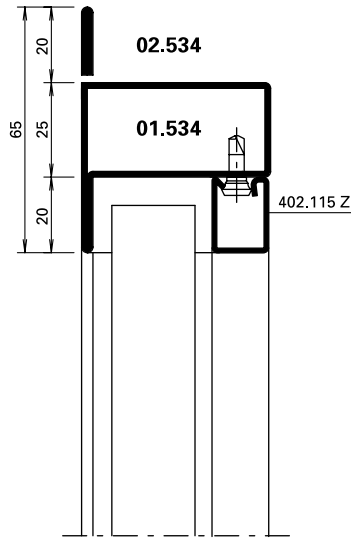
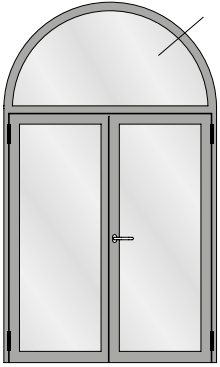

Halbrundbogen
 Arc semi-circulaire
 Semi-circular arch

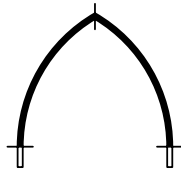

Spitzbogen
 Arc en ogive
 Gothic arch



Stichbogen
 Arc bombé
 Segmented arch



Korbbogen
 Anse de panier
 Oval arch

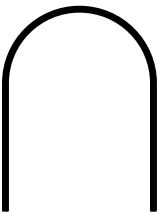

Halbrundbogen mit Schenkel
 Arc surhaussé prolongée
 Semi-circular arch with side extension

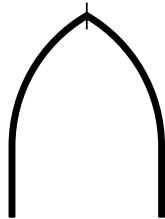

Spitzbogen mit Schenkel
 Arc en ogive prolongée
 Gothic arch with side extension

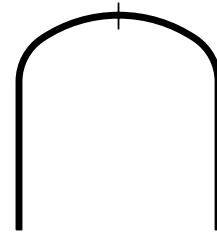



Korbbogen mit Schenkel
 Anse de panier prolongée
 Oval arch with side extension

Bogentüren
Portes cintrées
Arched doors

Jansen-Economy 50 E30
 Jansen-Economy 50 E30
 Jansen-Economy 50 E30

Profil Profilé Profile	Min. Radius Rayon min. Min. radius R	
------------------------------	---	--

	blank brut bright	verzinkt zinguée galvanised
	mm	mm
01.531	350	
01.534	400	800
01.564	650	1050
01.592	1100	

	blank brut bright	verzinkt zinguée galvanised
	mm	mm
02.531	350	600
02.534	400	800
02.564	650	1050

	blank brut bright	verzinkt zinguée galvanised
	mm	mm
03.531	600	
03.534	500	800

	blank brut bright	verzinkt zinguée galvanised
	mm	
04.568	850	

	blank brut bright	verzinkt zinguée galvanised
	mm	mm
05.568	850	1250

	blank brut bright	verzinkt zinguée galvanised
	mm	mm
400.048	550	650
400.049	550	850
81.009	1050	

Profil Profilé Profile	Min. Radius Rayon min. Min. radius R	
------------------------------	---	--

	blank brut bright	verzinkt zinguée galvanised
	mm	mm
30.006	500	500
30.007	550	550

	blank brut bright	verzinkt zinguée galvanised
	mm	mm
30.106	700	700
30.107	750	750

	blank brut bright	verzinkt zinguée galvanised
	mm	mm
30.406	700	700
30.407	750	750

Stahl-Glasleisten Parcloses en acier Steel glazing beads	Min. Radius Rayon min. Min. radius R
--	---

	
402.112 Z	500 mm
402.115 Z	500 mm
402.120 Z	600 mm
402.125 Z	750 mm
402.130 Z	1000 mm
402.135 Z	1500 mm

Stahl-Glasleisten Parcloses en acier Steel glazing beads	Min. Radius Rayon min. Min. radius R
--	---

	
62.507 Z	300 mm
62.508 Z	300 mm
62.509 Z	300 mm

Biegen von Edelstahl-Profilen auf Anfrage!

Die Radien-Angaben beziehen sich auf die langjährige Erfahrung und Fertigung im Hause Jansen.

Profilés acier Inox sur demande!

Les rayons indiqués se fondent sur la longue expérience et la fabrication au sein de la maison Jansen.

Stainless steel profiles on request!

The radii specifications are based on the many years of experience Jansen has in fabrication.

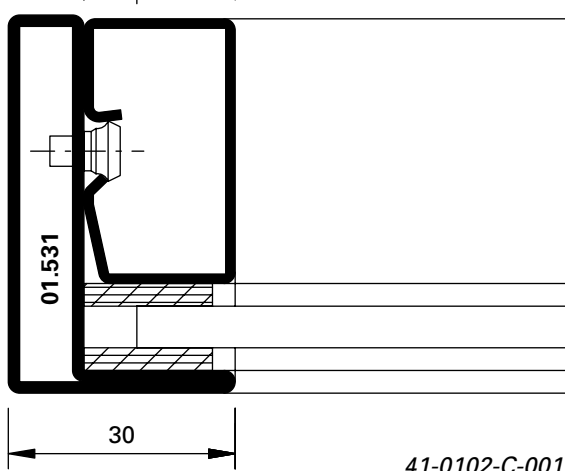
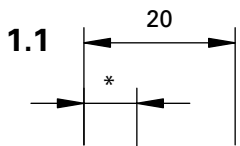
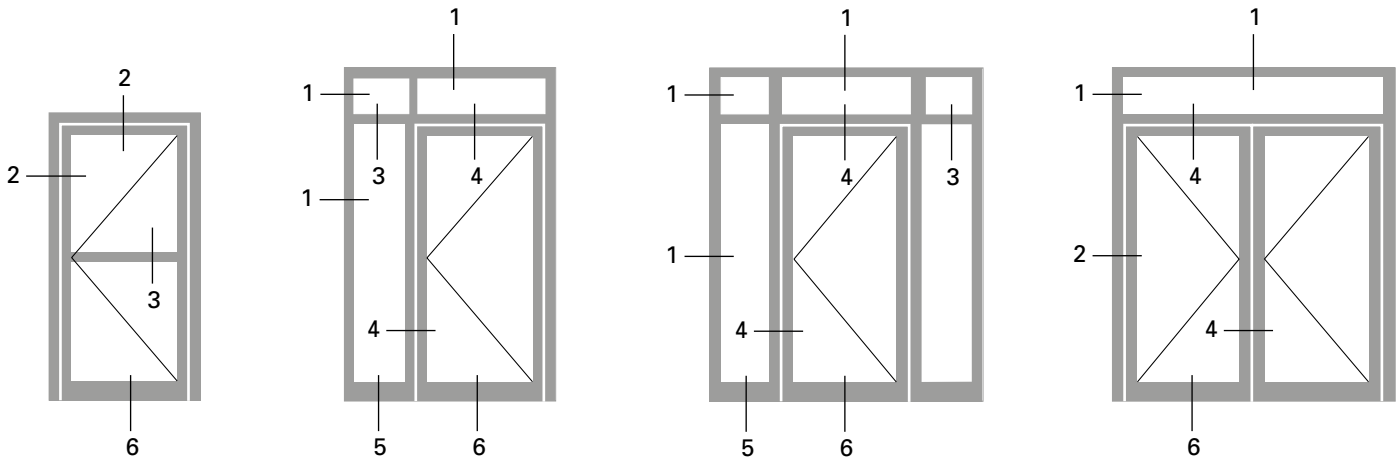

DXF DWG

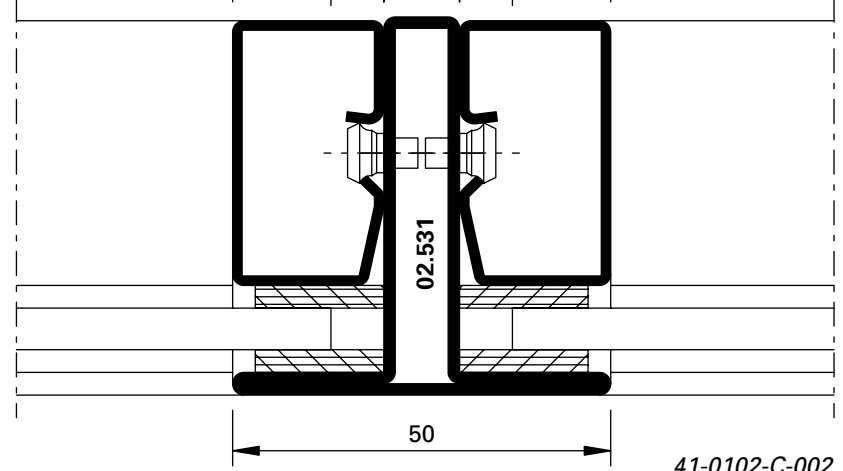
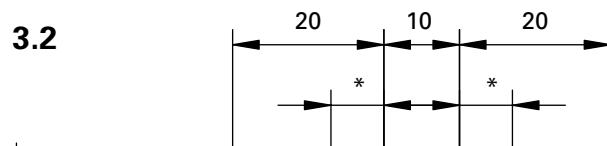

DXF DWG

1.0

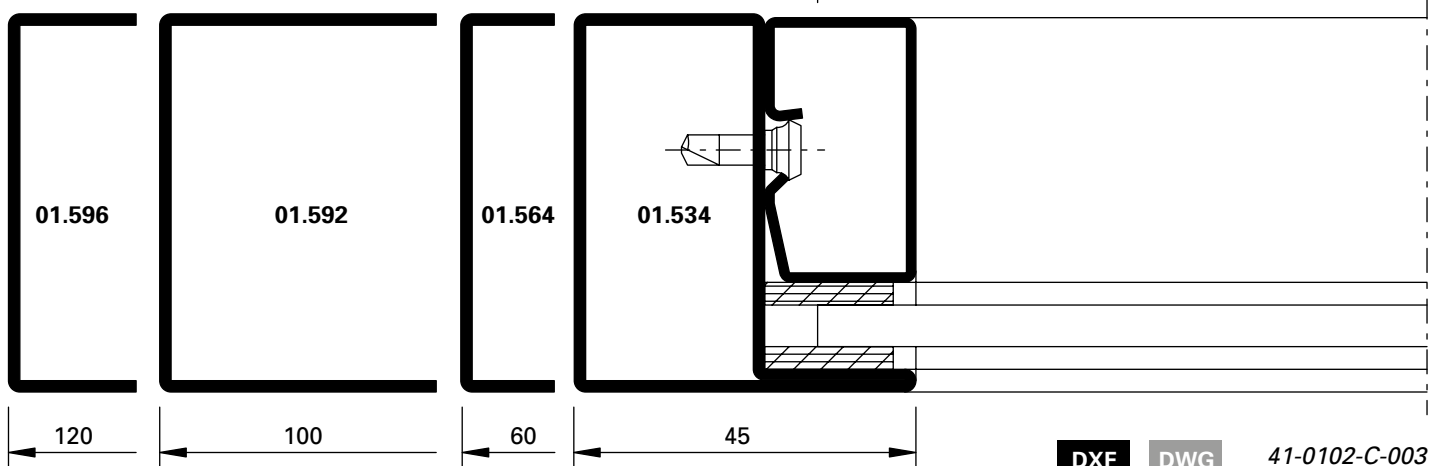
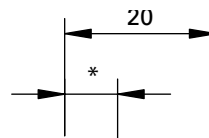

DXF DWG

* Je nach Glasfabrikat

* Selon le fabricant du vitrage

* Depending on the make of glass

2.0

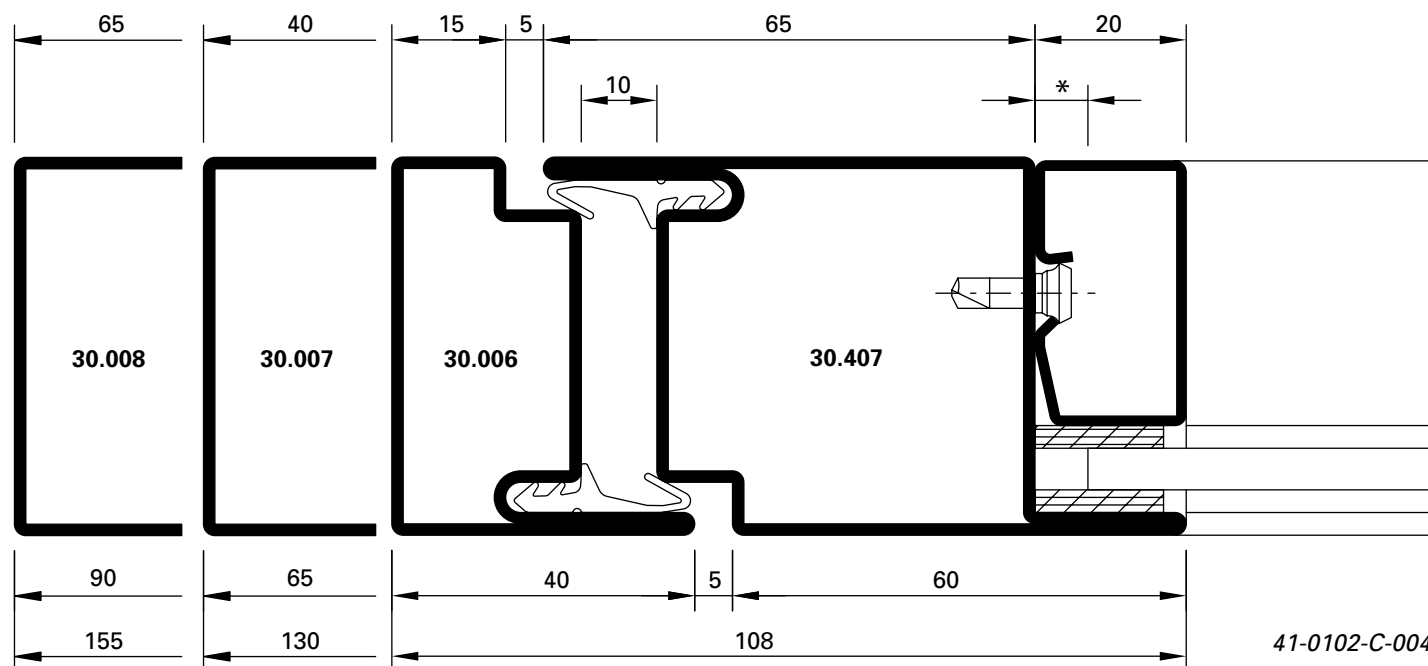

41-0102-C-004

DXF DWG

2.1

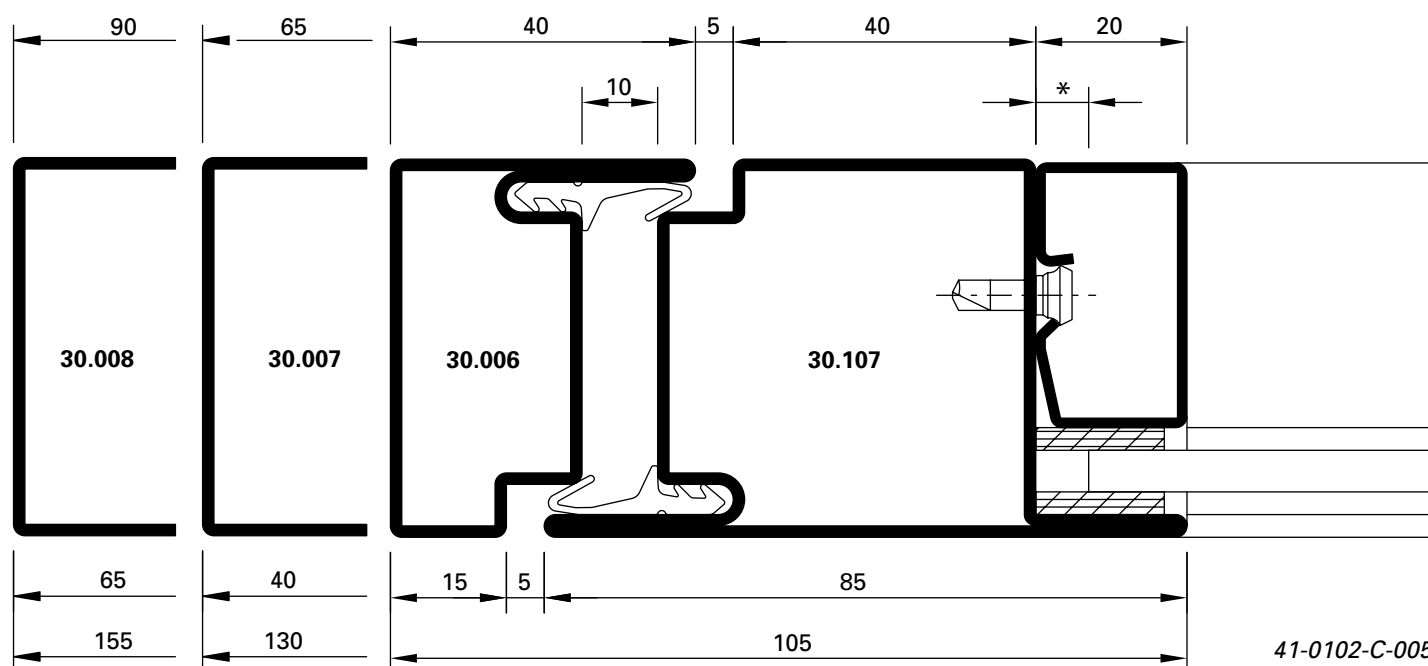

41-0102-C-005

DXF DWG

* Je nach Glasfabrikat

* Selon le fabricant du vitrage

* Depending on the make of glass

4.0

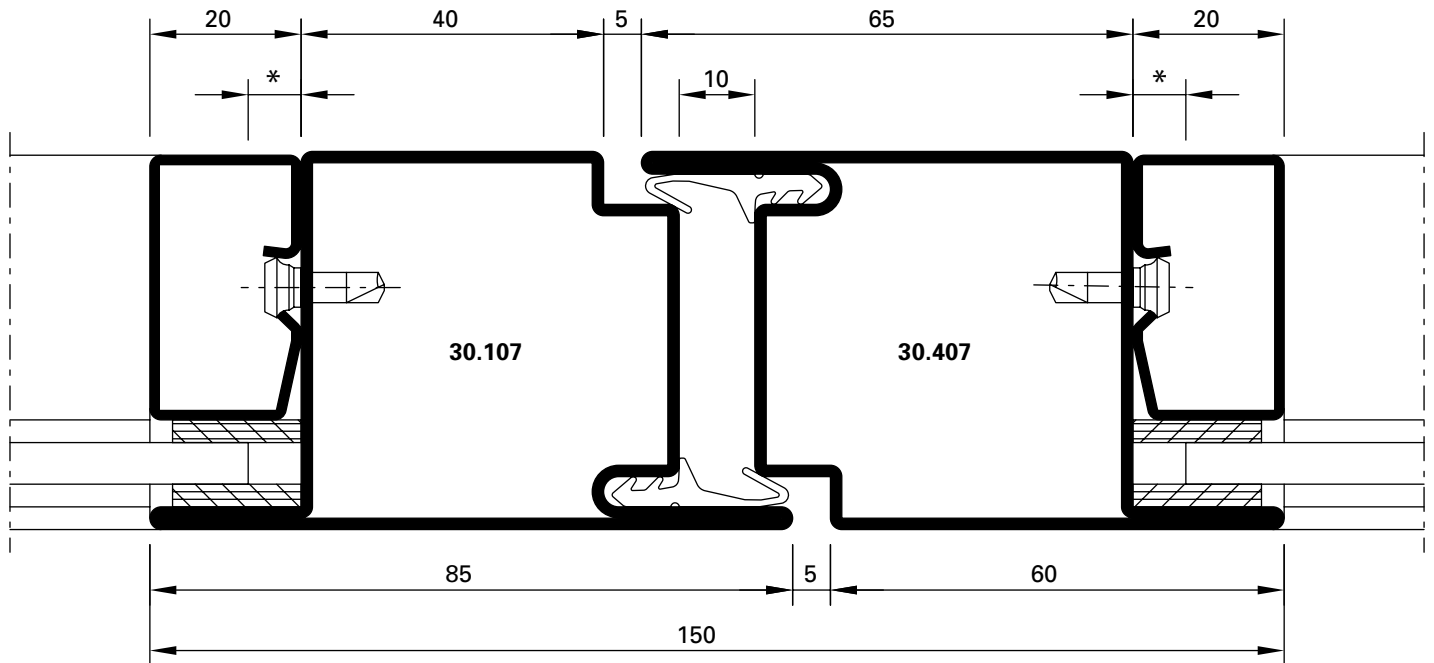

DXF DWG 41-0102-C-006

4.1

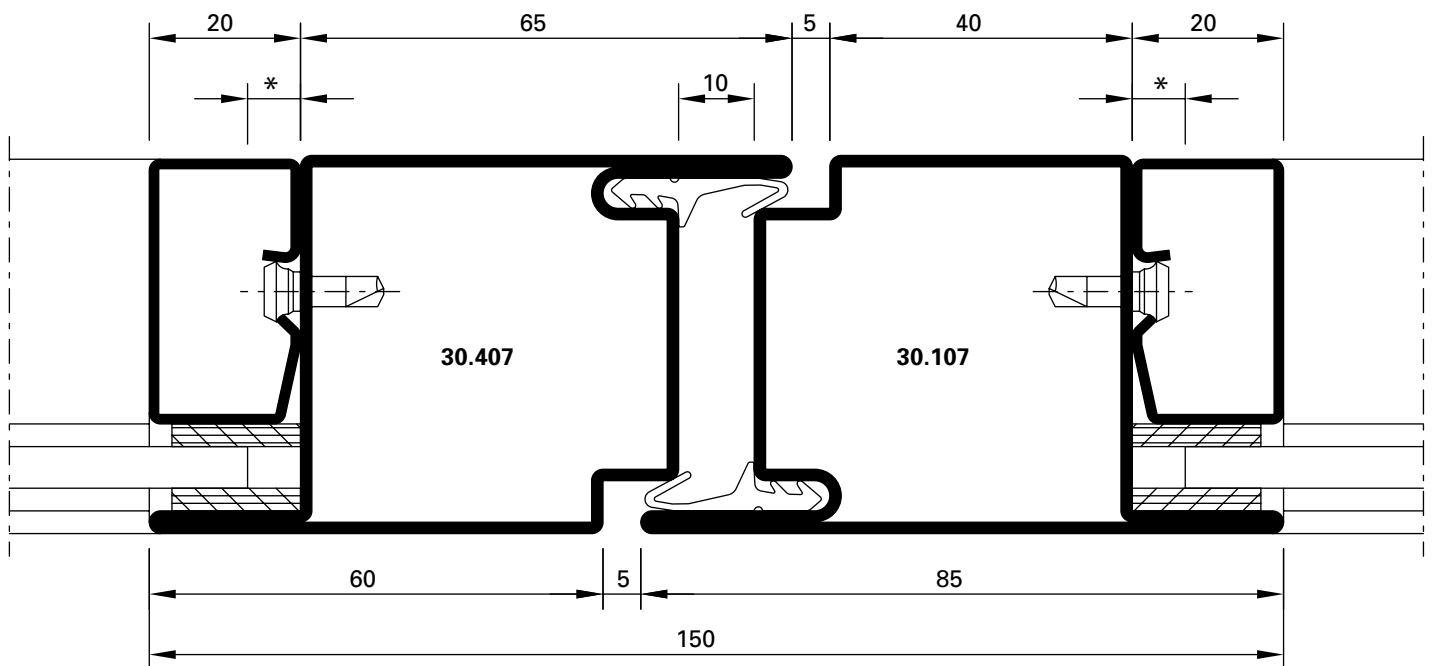

DXF DWG 41-0102-C-007

* Je nach Glasfabrikat

* Selon le fabricant du vitrage

* Depending on the make of glass

2.2

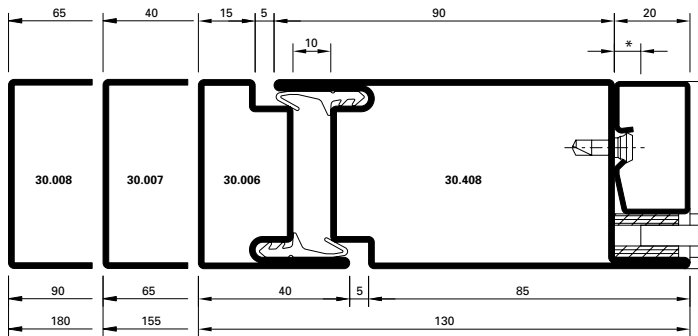

DXF **DWG** 41-0102-C-008

2.3

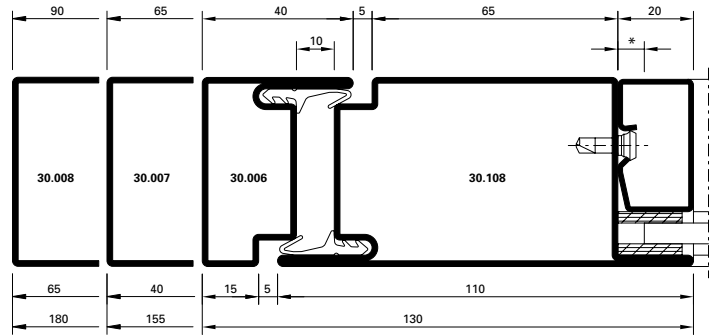

DXF **DWG** 41-0102-C-009

2.4

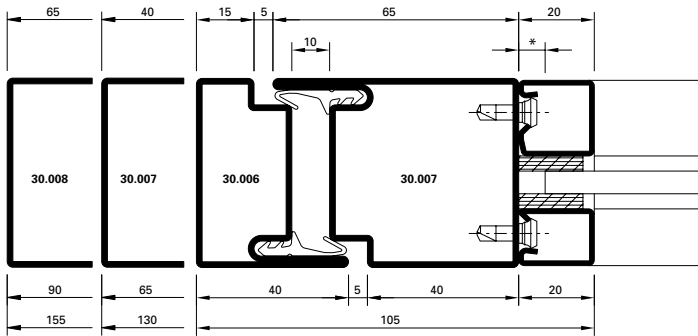

DXF **DWG** 41-0102-C-010

4.2

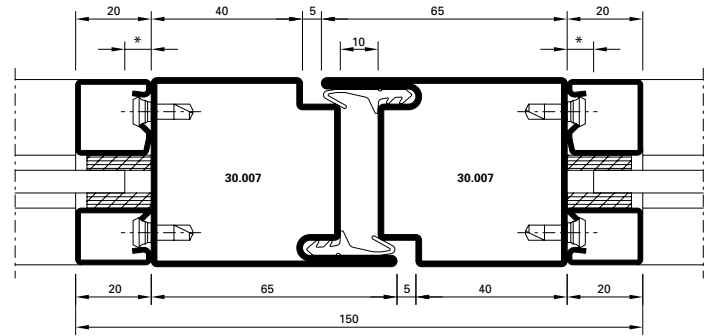

DXF **DWG** 41-0102-C-011

3.0

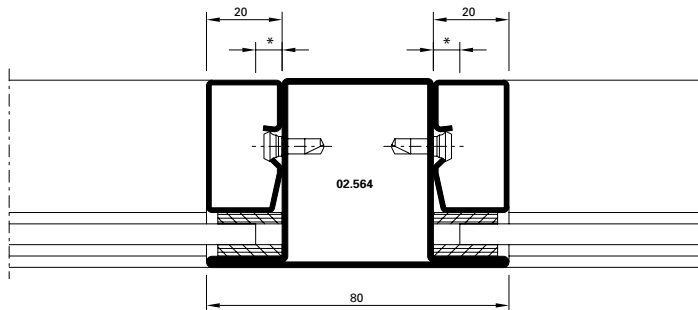

DXF **DWG** 41-0102-C-012

3.1

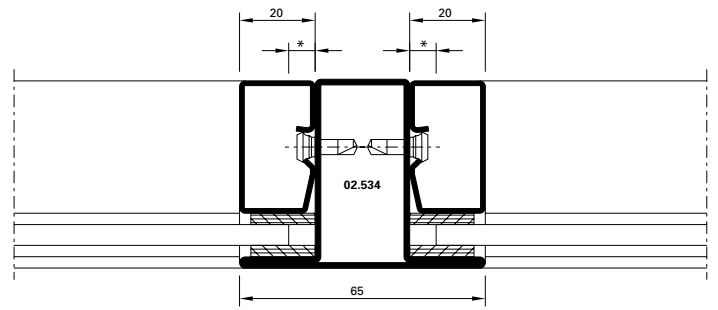

DXF **DWG** 41-0102-C-013

* Je nach Glasfabrikat

* Selon le fabricant du vitrage

* Depending on the make of glass

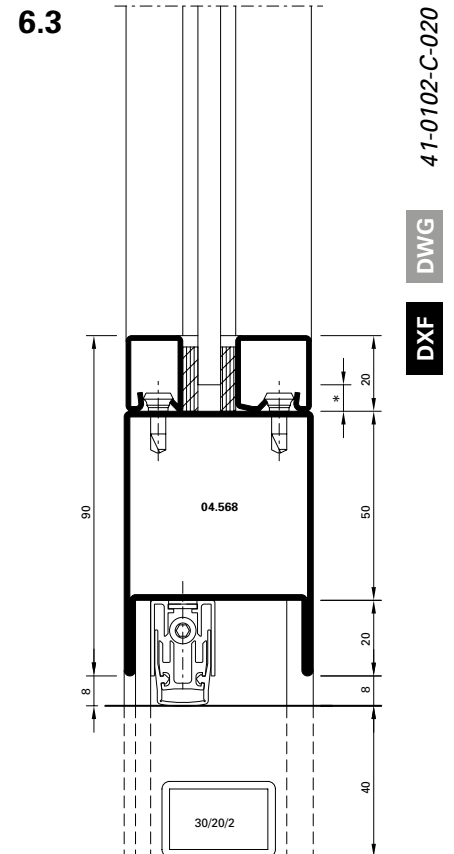
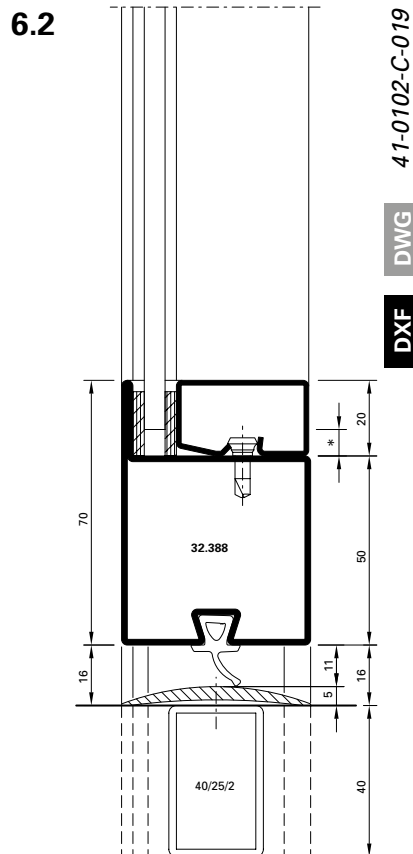
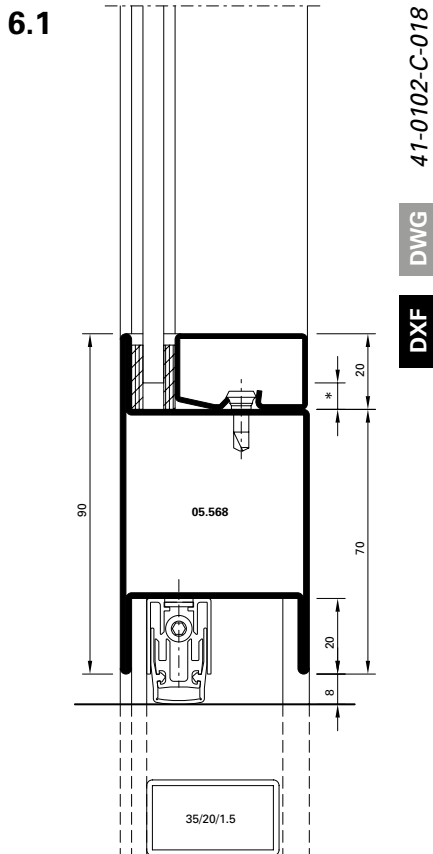
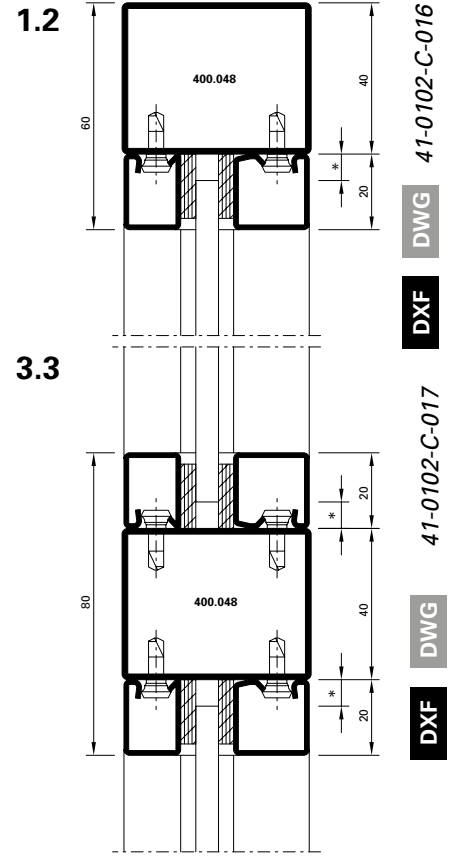
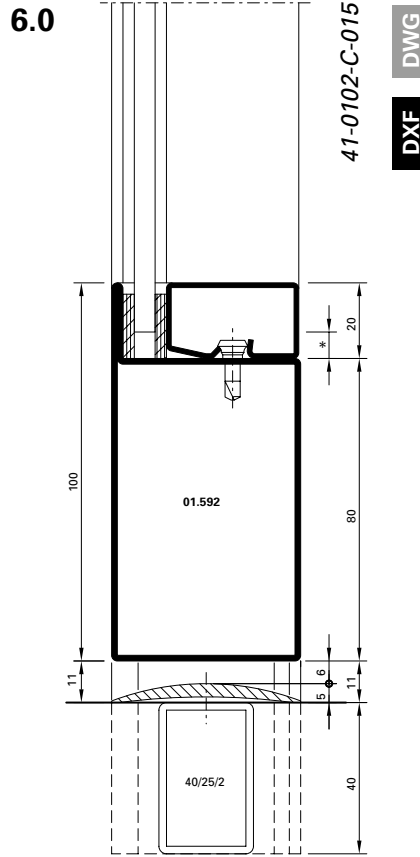
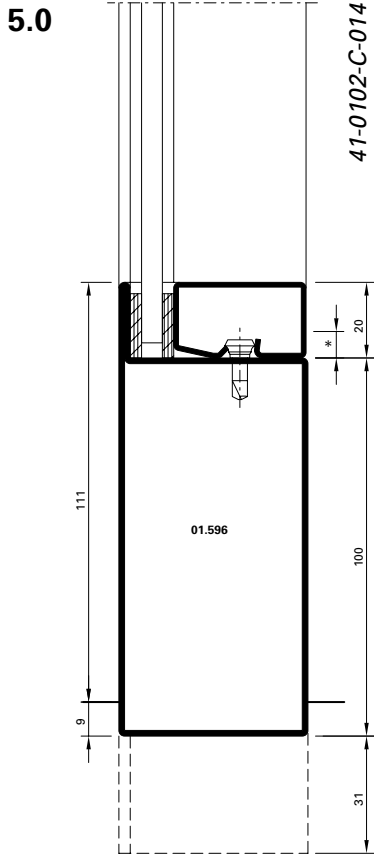

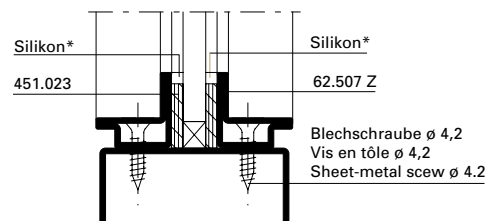
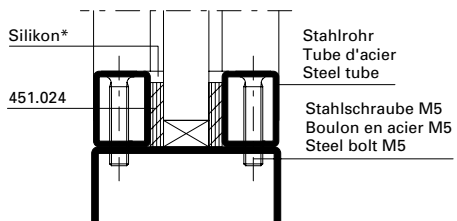
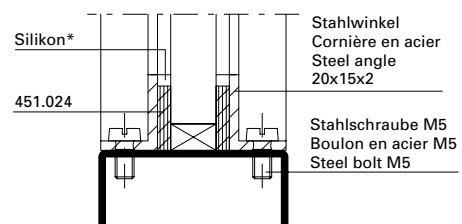
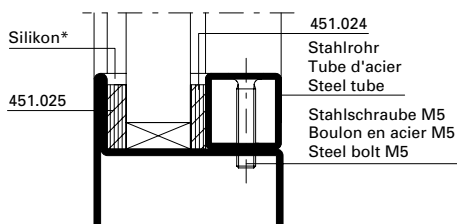
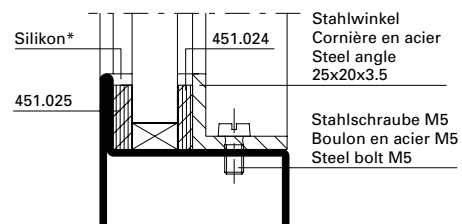
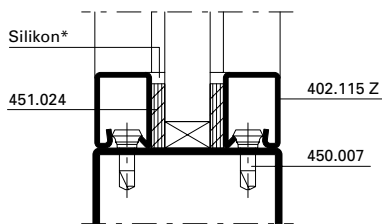
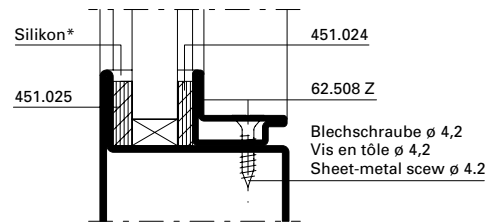
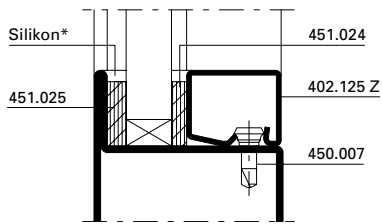
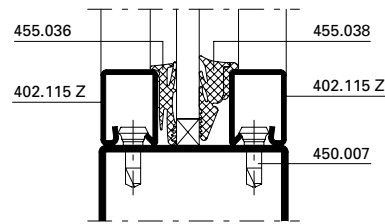
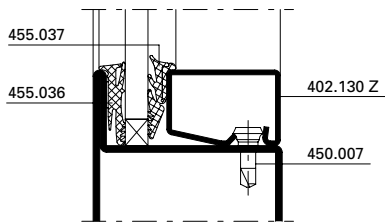

* Brandschutz-Silikon wahlweise

* Silicon difficilement combustible au choix

* Fire resistant silicone optional

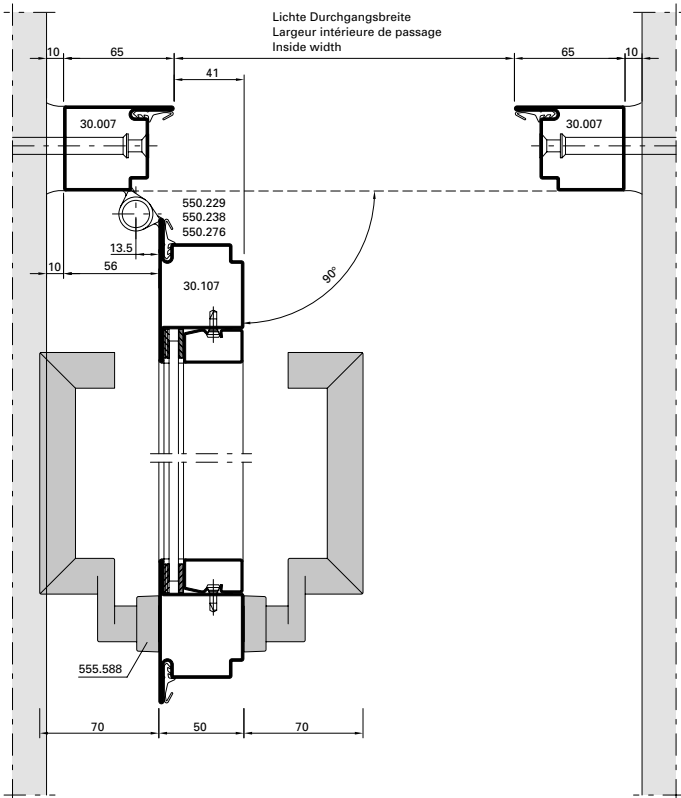

DXF DWG 41-0102-E-001

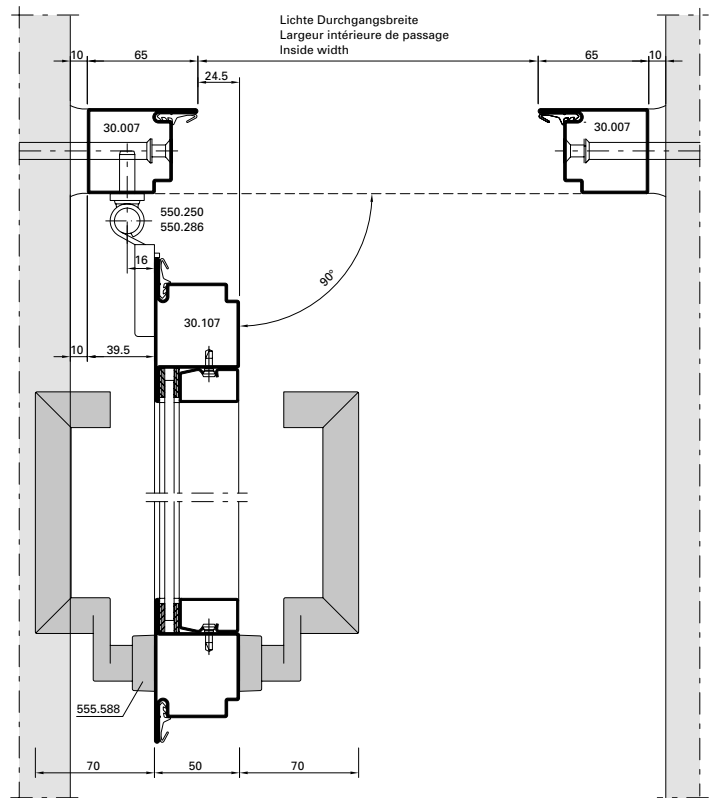

DXF DWG 41-0102-E-005

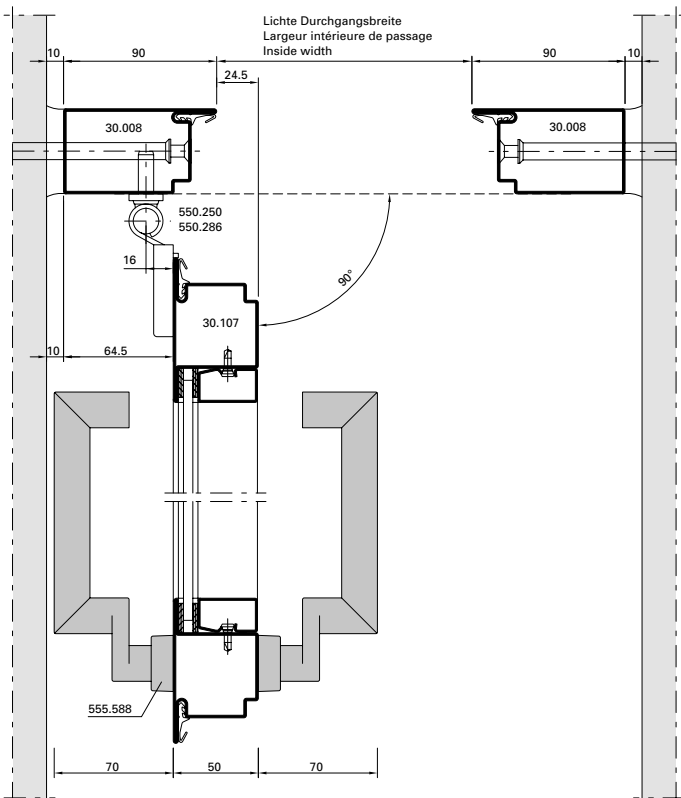

DXF DWG 41-0102-E-004

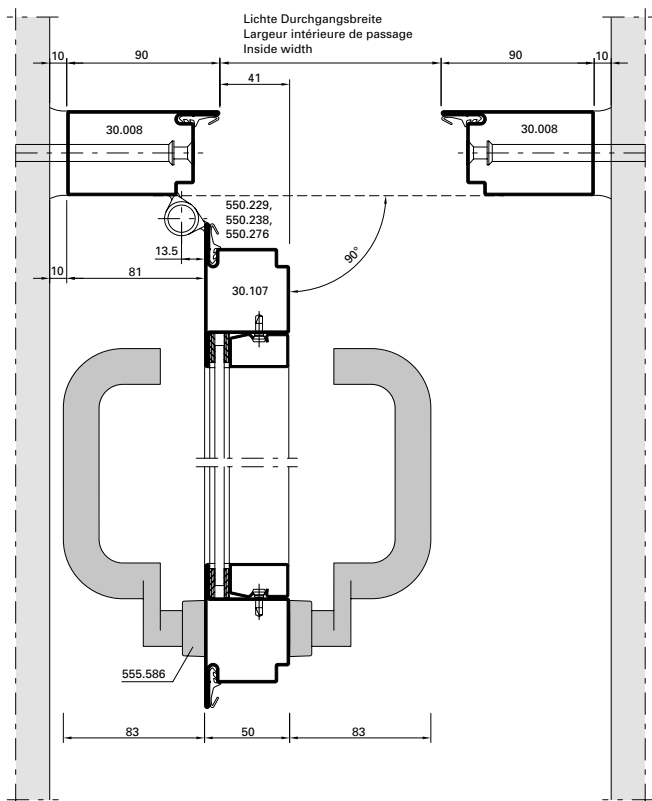

DXF DWG 41-0102-E-002

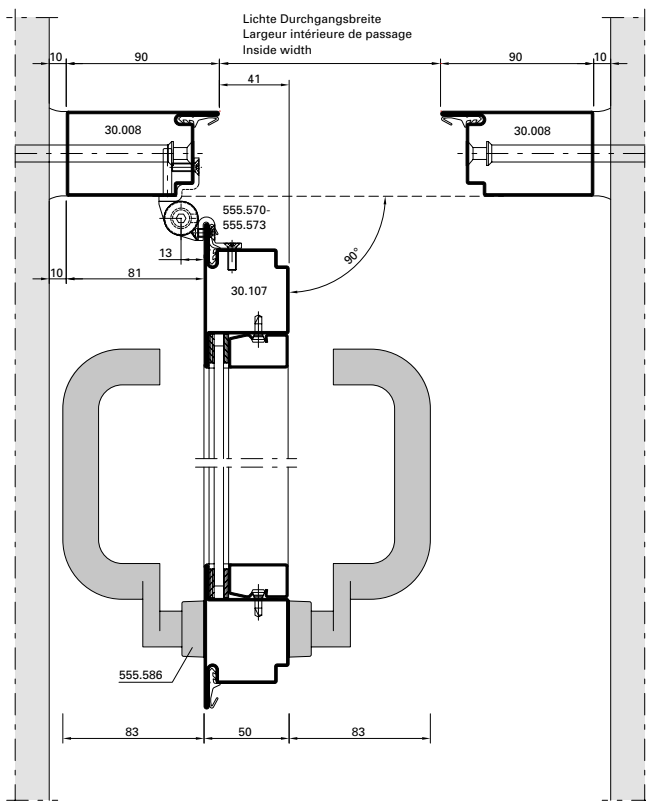

DXF DWG 41-0102-E-006

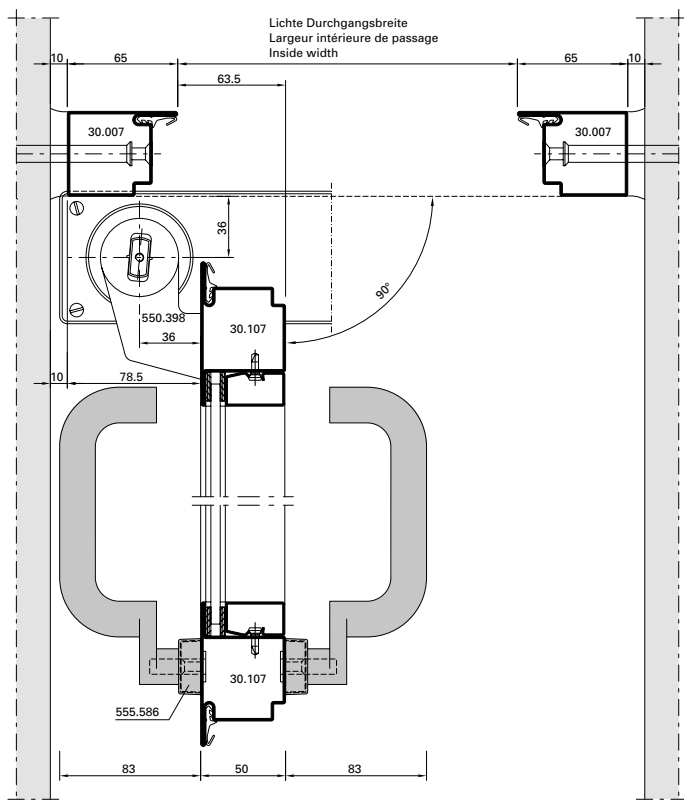

DXF DWG 41-0102-E-003

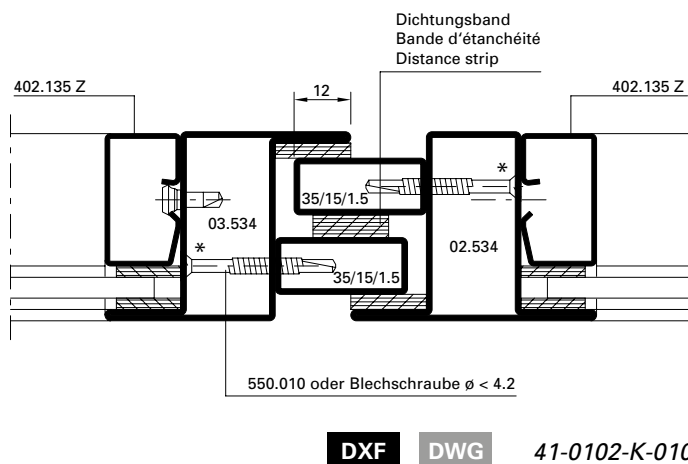
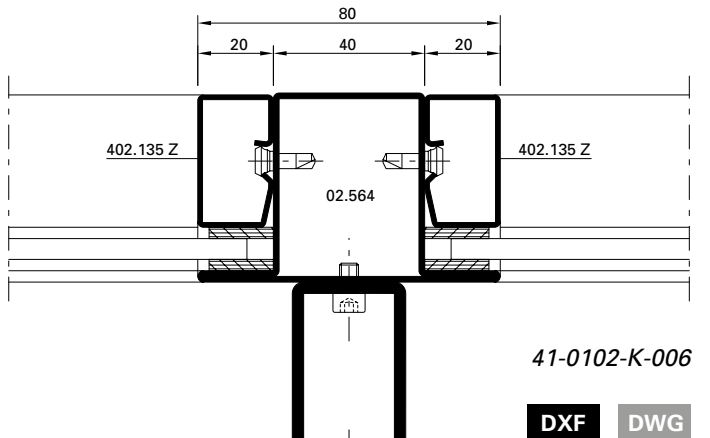
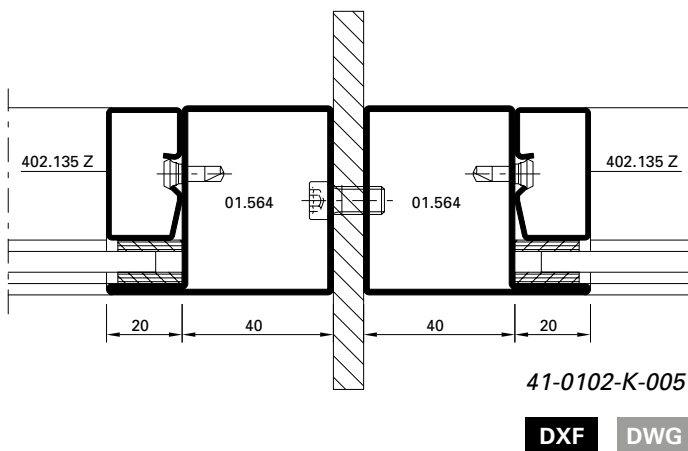
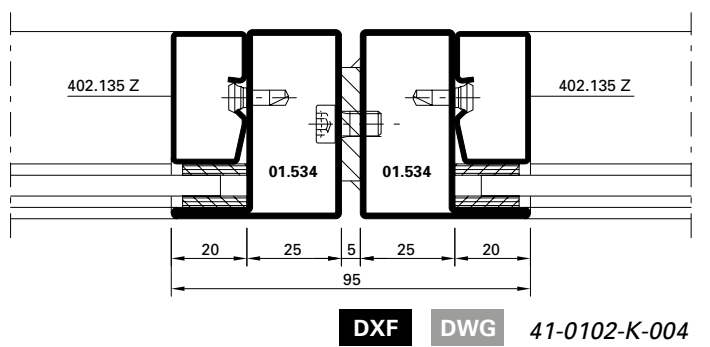
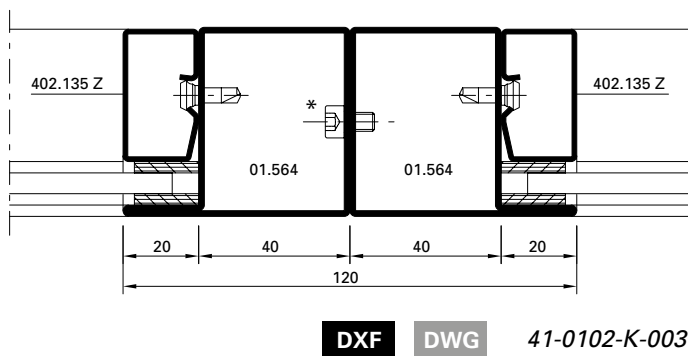
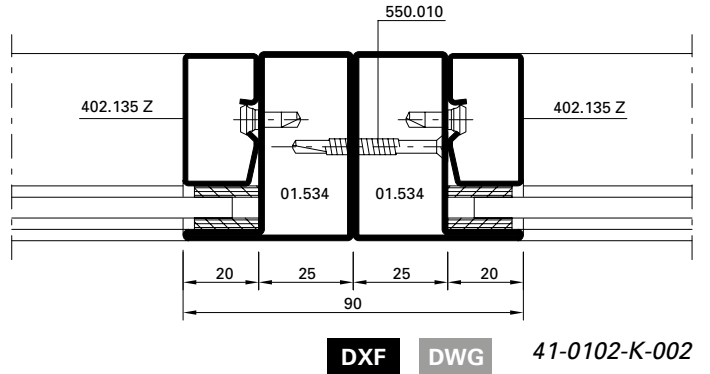
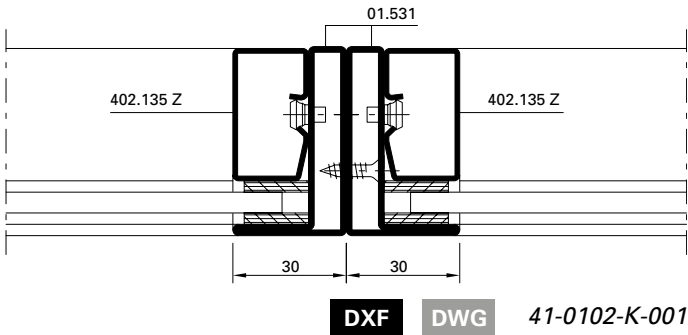

* Schrauben-Abstand ≤ 500 mm
 * Distance des vis ≤ 500 mm
 * Screw distance ≤ 500 mm

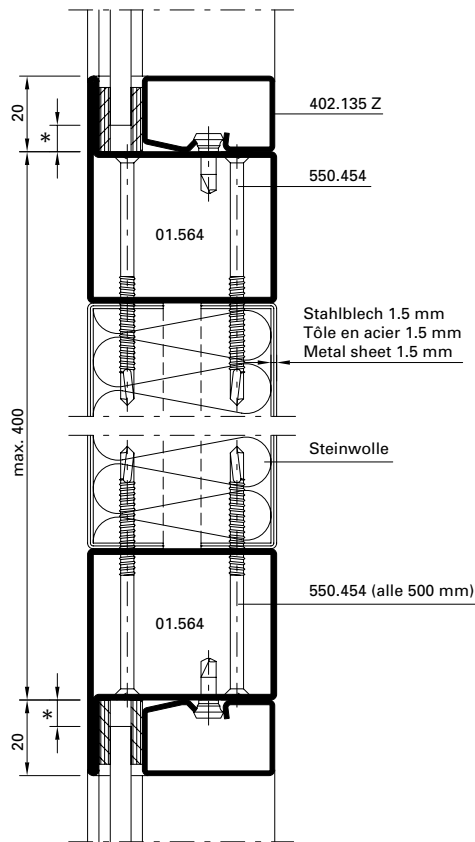

41-0102-K-020

DWG

DXF

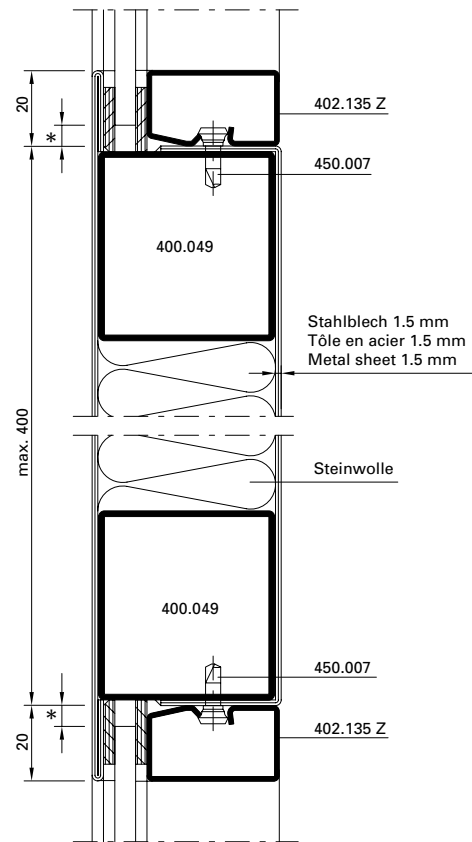

41-0102-K-015

DWG

DXF

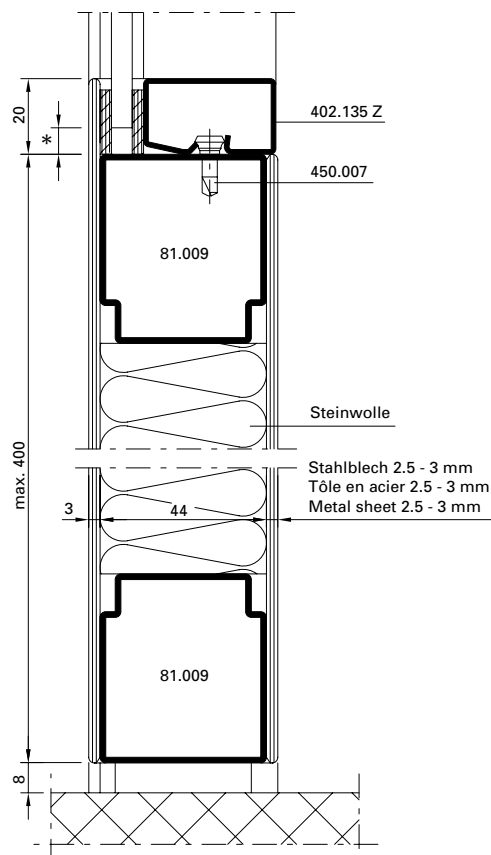

41-0102-K-016

DWG

DXF

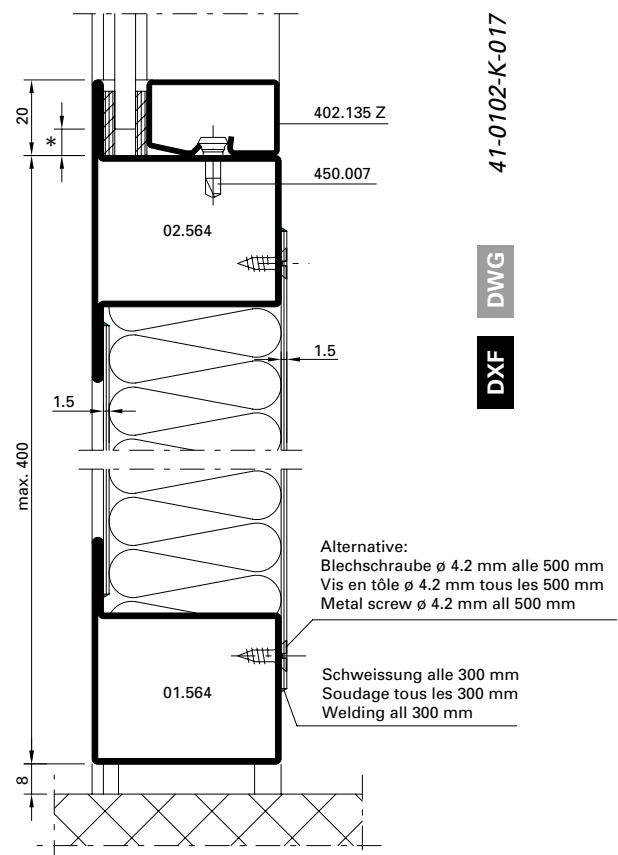

41-0102-K-017

DWG

DXF

* Je nach Glasfabrikat

* Selon le fabricant du vitrage

* Depending on the make of glass

T-Verbinder schraubbar

Raccord en T à visser

Screwable connecting spigot

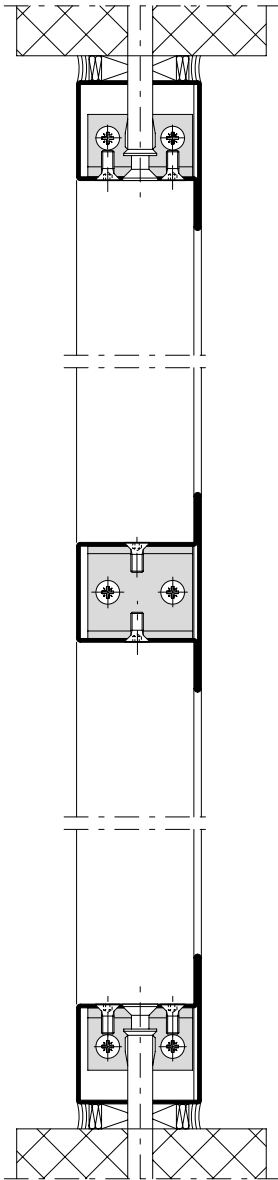

Stahlschraube M5 wahlweise Blindnietmutter M5
 Boulon en acier M5 au choix écrou rivet aveugle M5
 Steel bolt M5 optional blind rivet nut M5

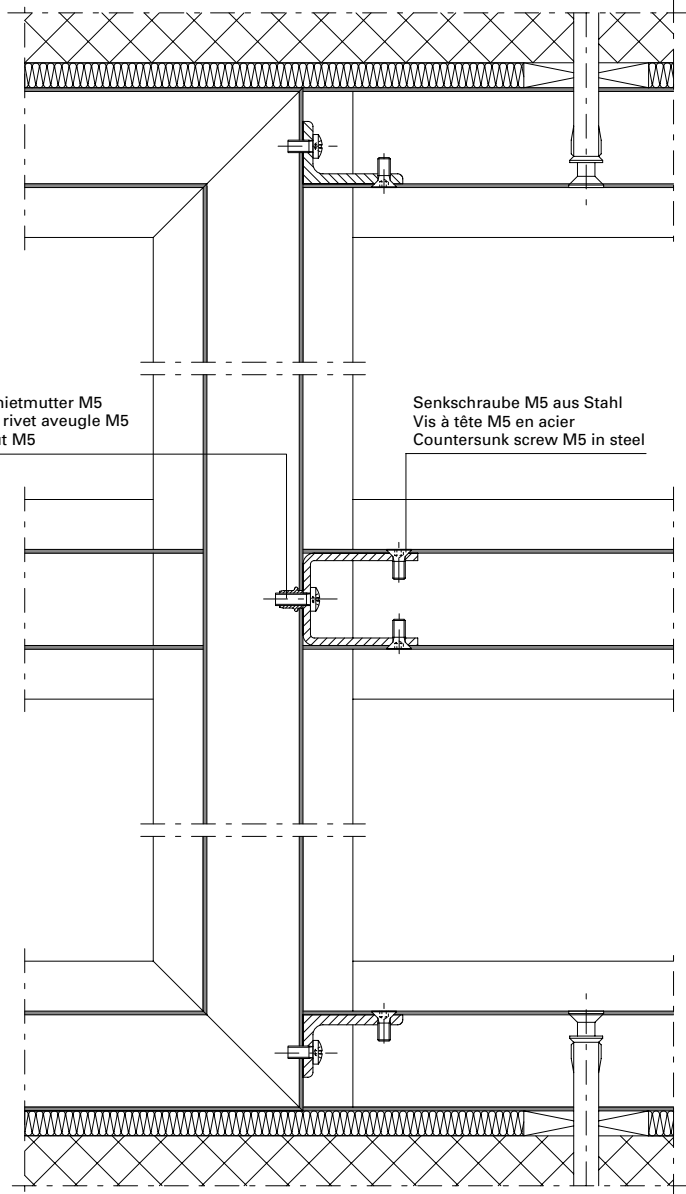

Senkschraube M5 aus Stahl
 Vis à tête M5 en acier
 Countersunk screw M5 in steel

T-Verbinder aus Winkelstahl*
 Raccord en T en cornière en acier*
 Connecting spigot in steel angle*

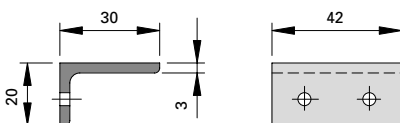

T-Verbinder aus U-Profil*
 Raccord en T en profilé en U*
 Connecting spigot in U profile*

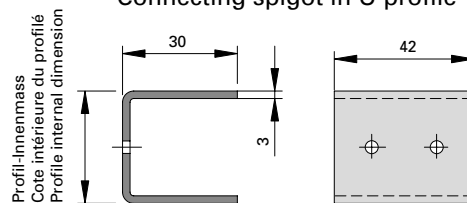

* Durch Metallbauer herzustellen

* A fabriquer par le constructeur

* To be manufactured by metal worker

Element-Kopplungen

Couplages d'éléments

Coupling element

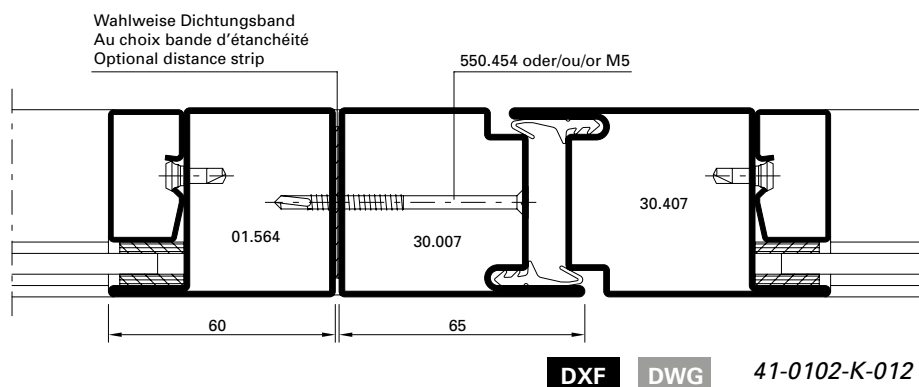
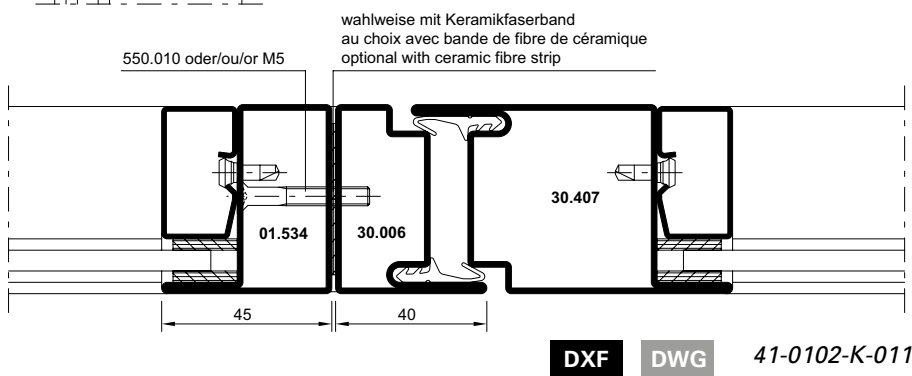
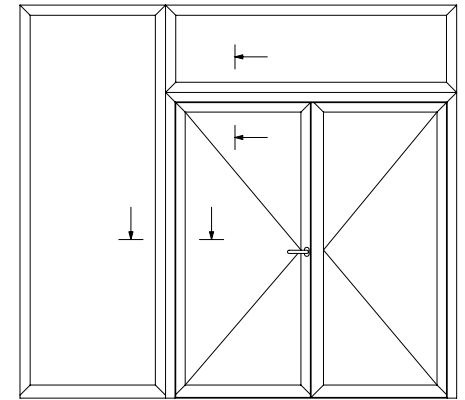
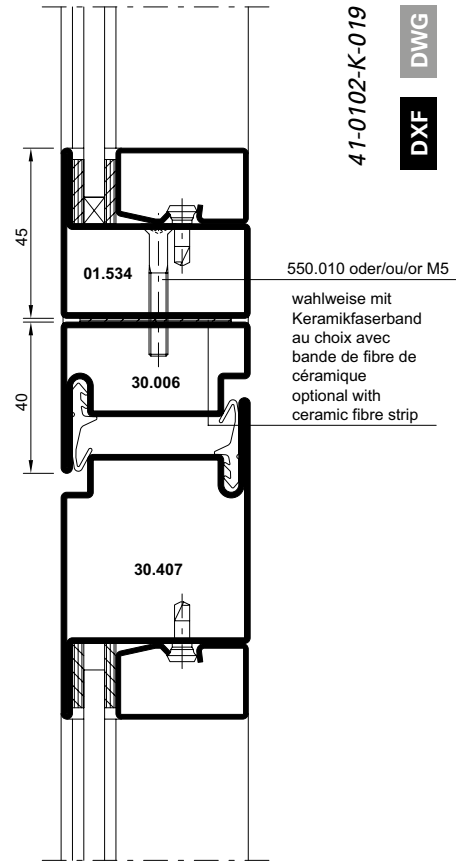
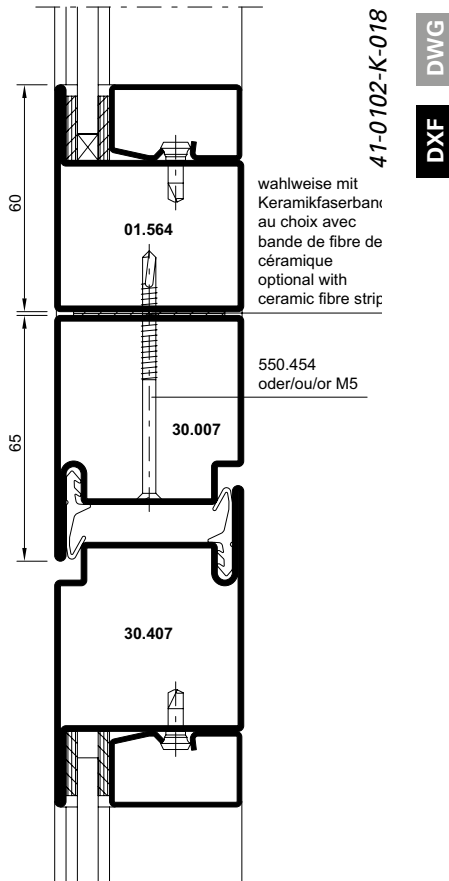

- * Schrauben-Abstand ≤ 500 mm
- * Distance des vis ≤ 500 mm
- * Screw distance ≤ 500 mm

Anschlüsse am Bau im Massstab 1:2

Raccords au mur à l'échelle 1:2

Attachment to structure on scale 1:2

Jansen-Economy 50 E30

Jansen-Economy 50 E30

Jansen-Economy 50 E30

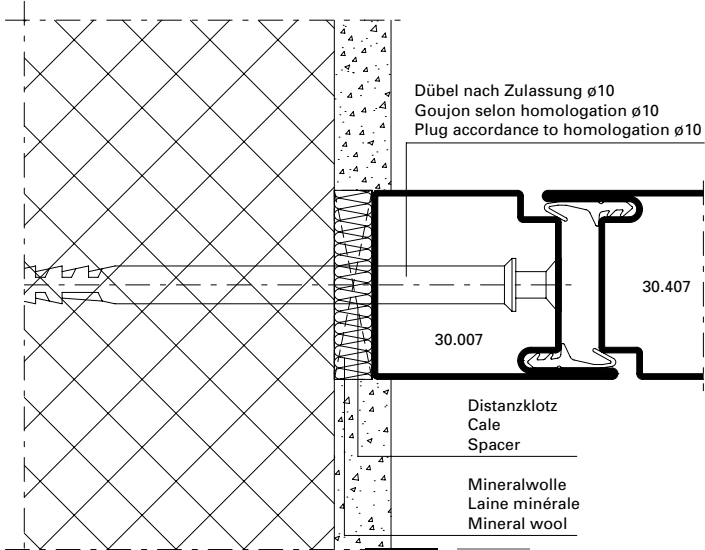

DXF DWG 41-0102-A-001

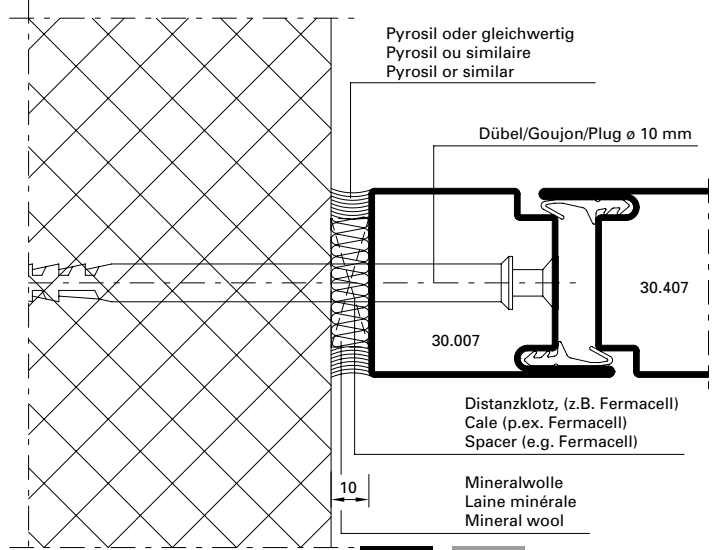

DXF DWG 41-0102-A-002

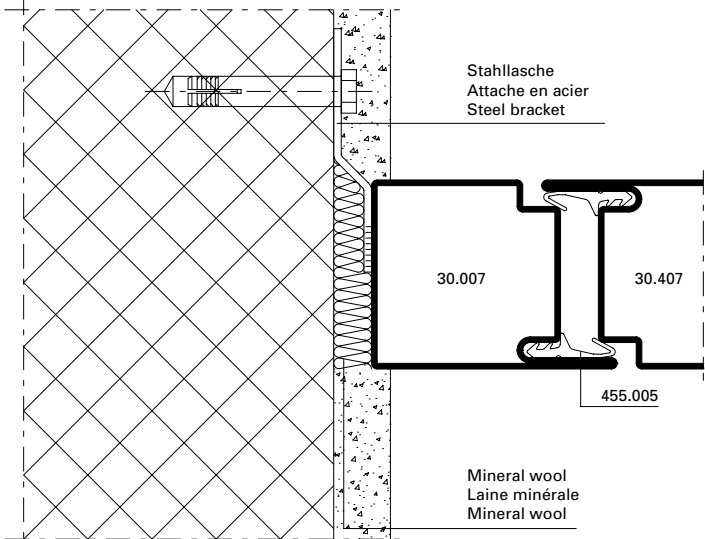

DXF DWG 41-0102-A-003

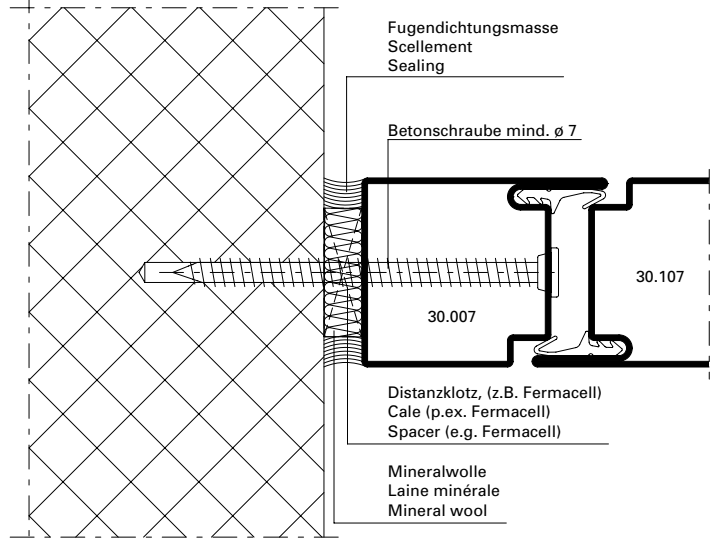

DXF DWG 41-0102-A-004

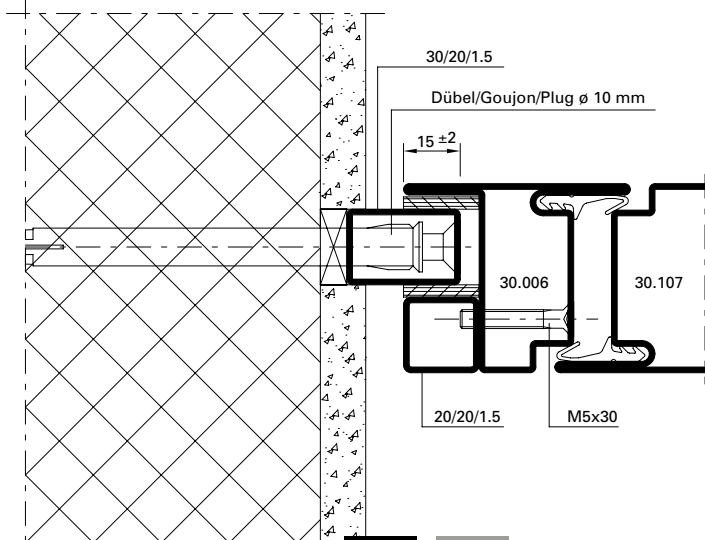

DXF DWG 41-0102-A-005

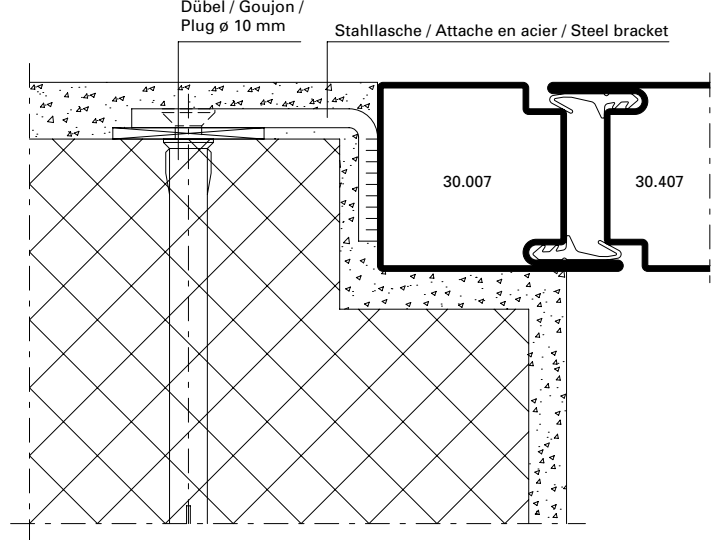

DXF DWG 41-0102-A-006

Anschlüsse am Bau im Masstab 1:2
Raccords au mur à l'échelle 1:2
Attachment to structure on scale 1:2

Jansen-Economy 50 E30
Jansen-Economy 50 E30
Jansen-Economy 50 E30

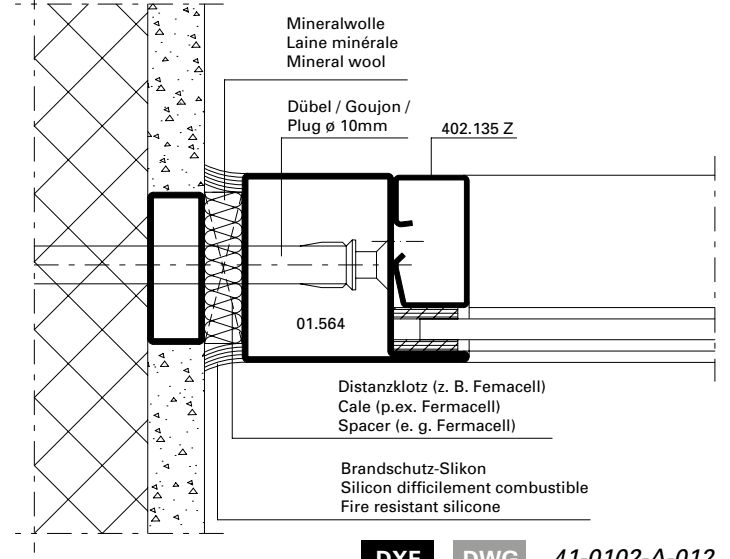
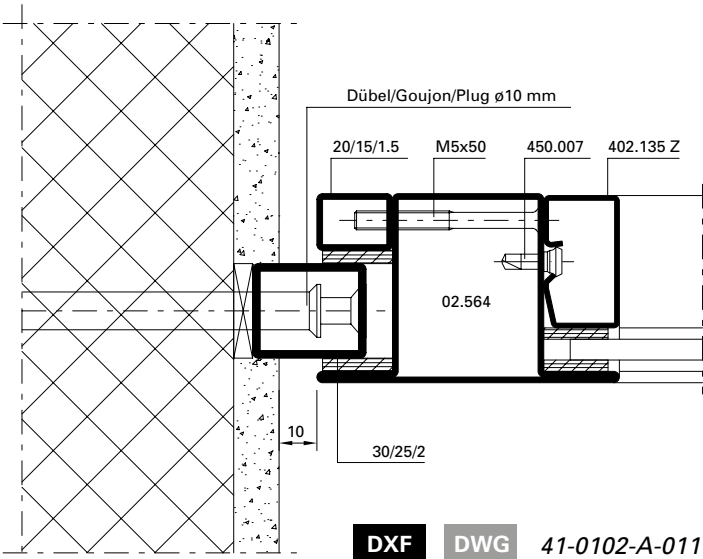
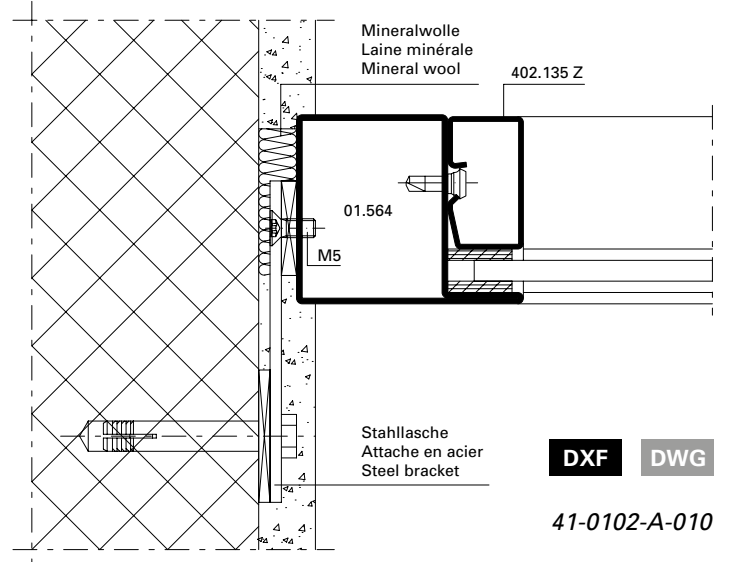
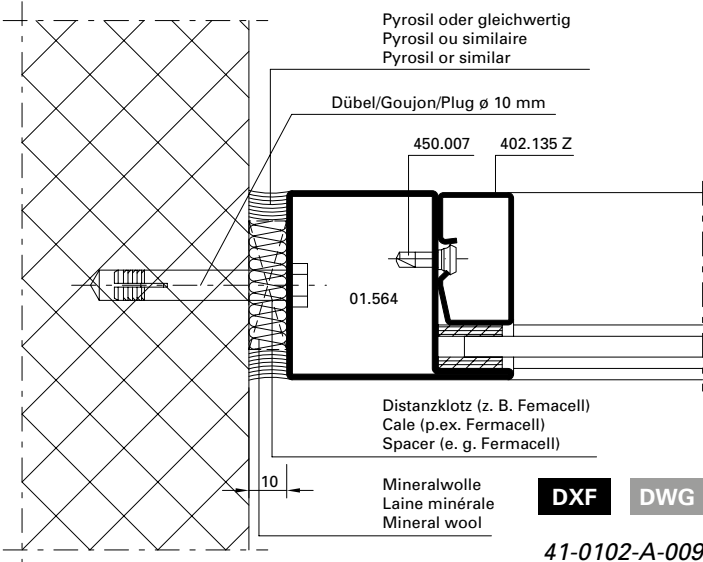
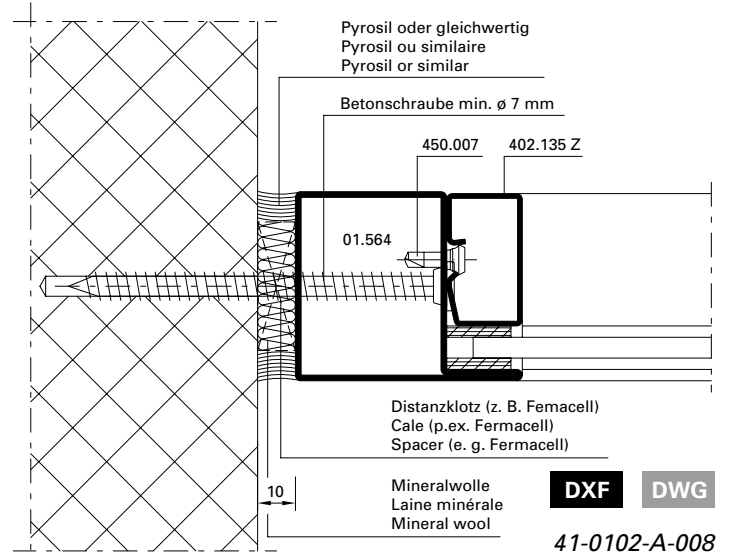
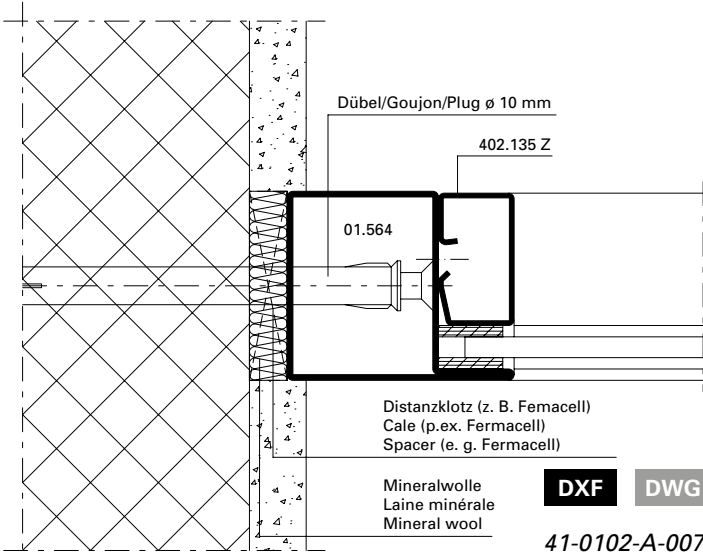

Anschlüsse am Bau im Massstab 1:2

Raccords au mur à l'échelle 1:2

Attachment to structure on scale 1:2

Jansen-Economy 50 E30

Jansen-Economy 50 E30

Jansen-Economy 50 E30

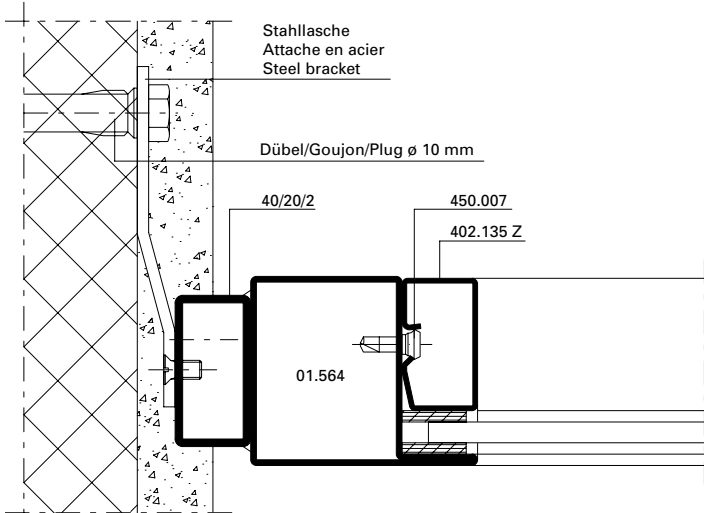

DXF DWG 41-0102-A-013

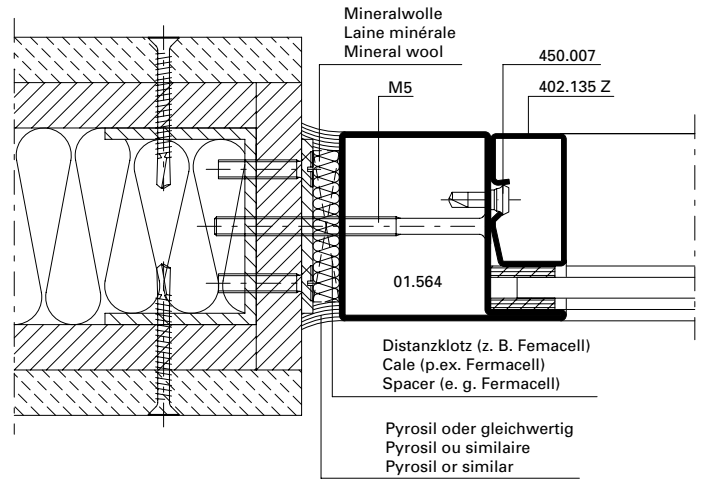

DXF DWG 41-0102-A-014

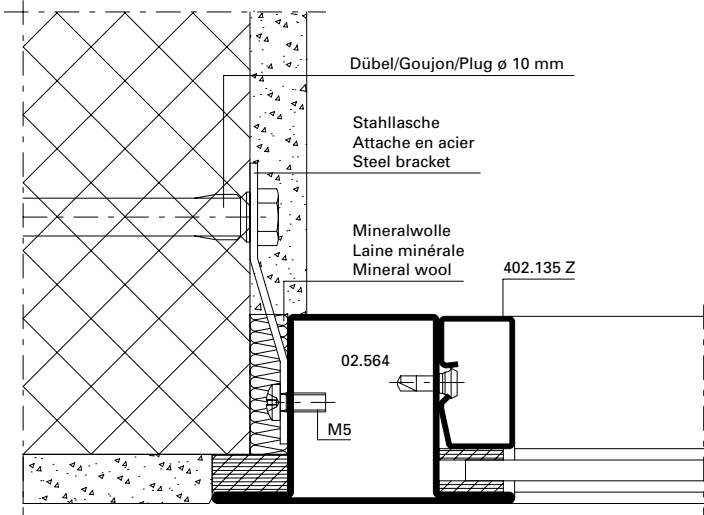

DXF DWG 41-0102-A-015

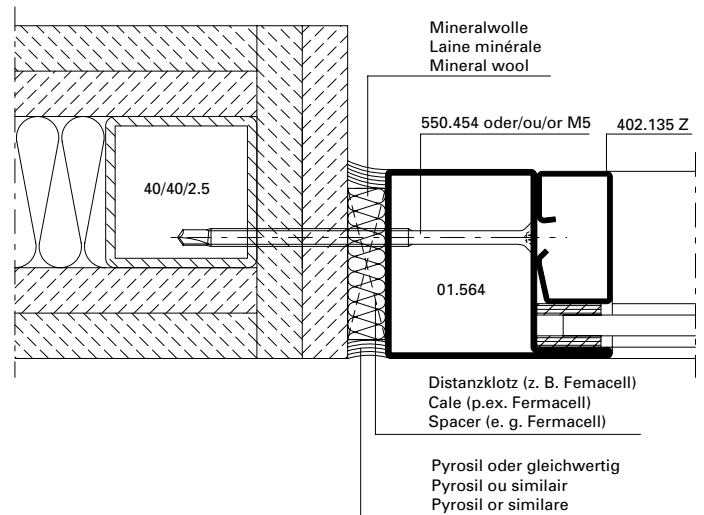

DXF DWG 41-0102-A-016

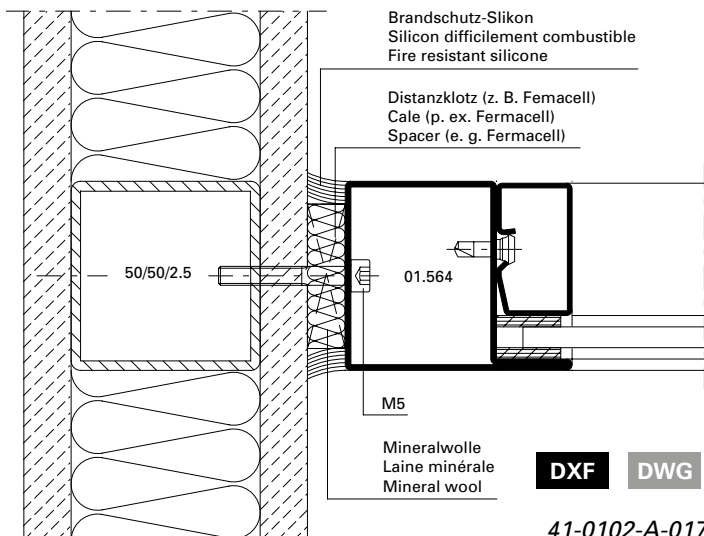

DXF DWG 41-0102-A-017

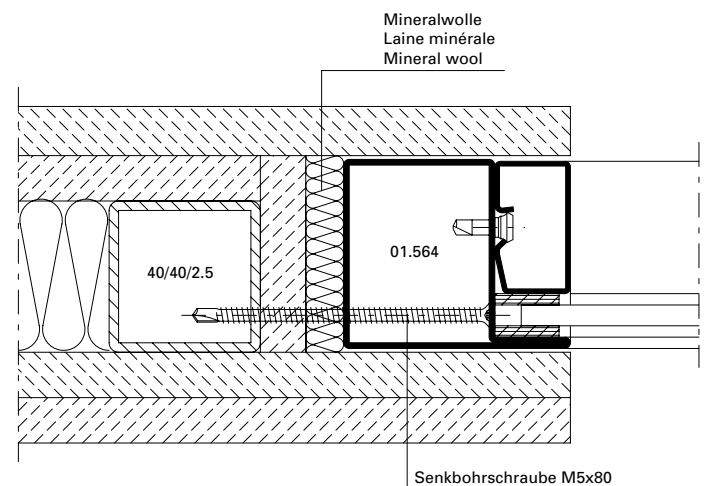

DXF DWG 41-0102-A-018

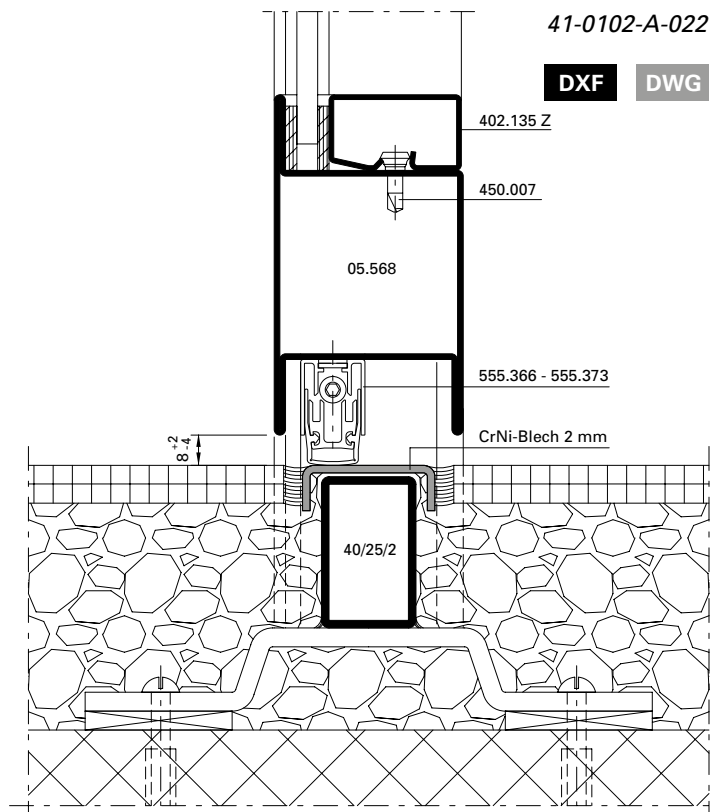
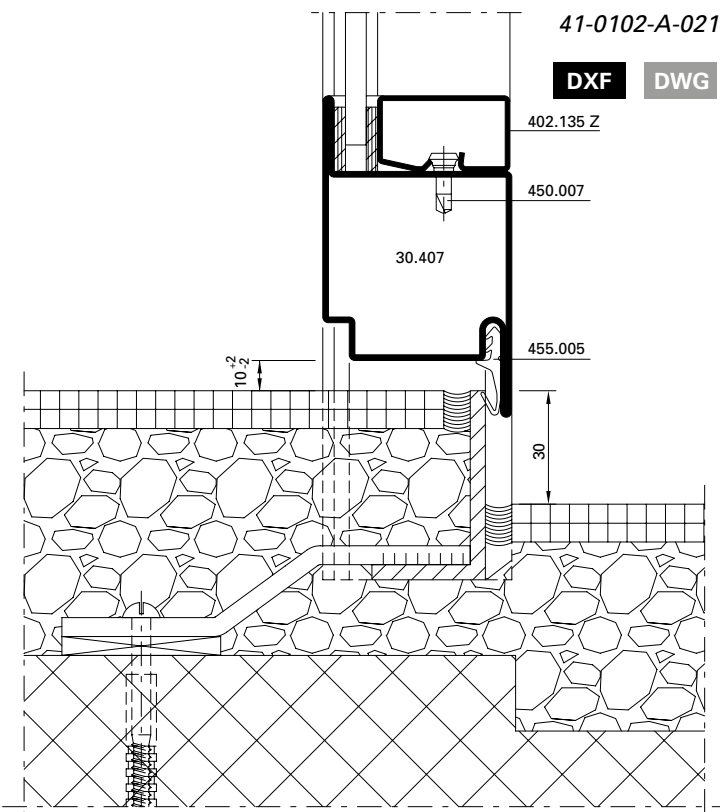
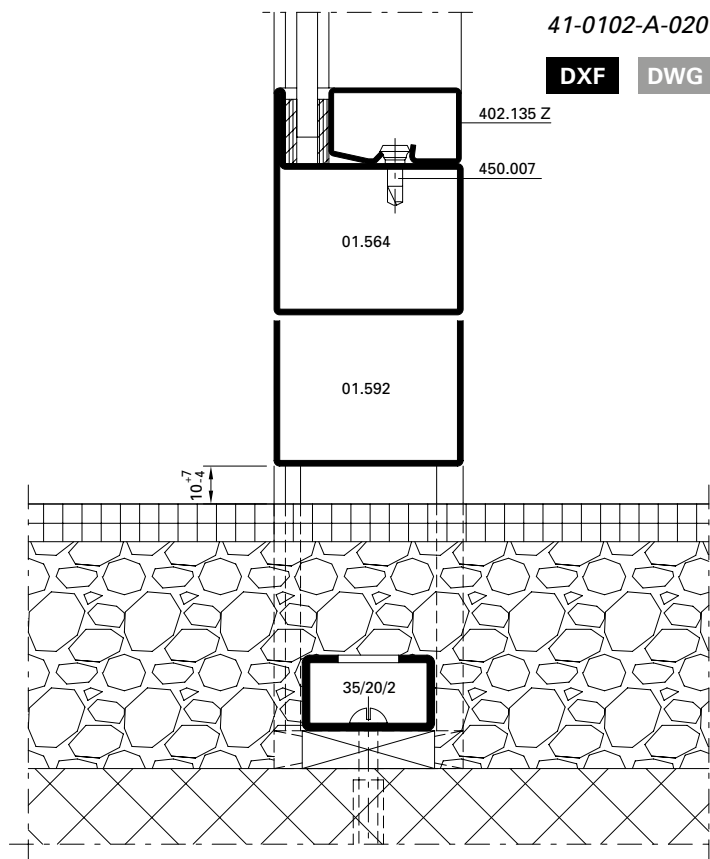
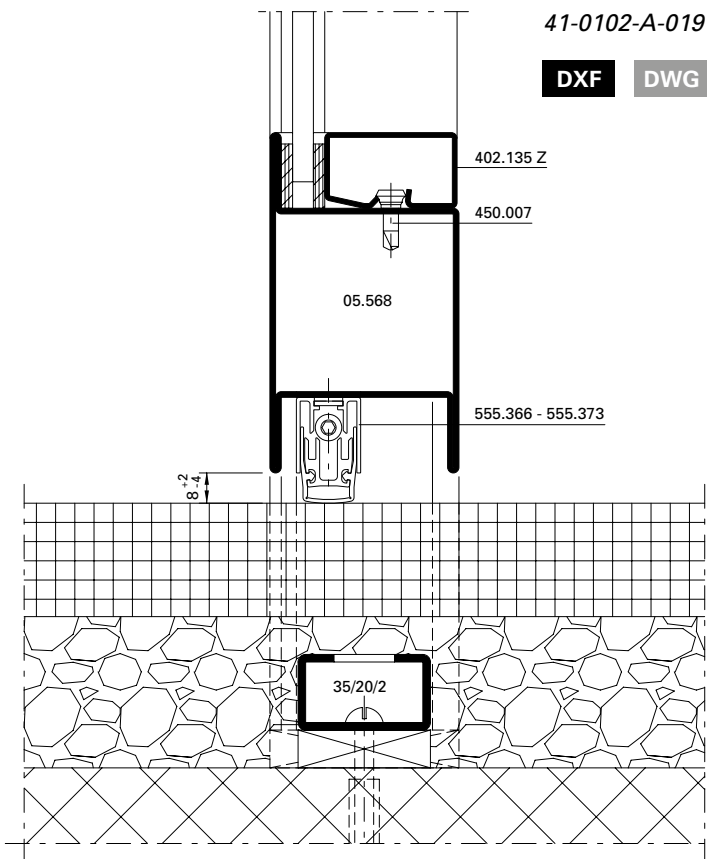

41-0102-A-023

DXF DWG

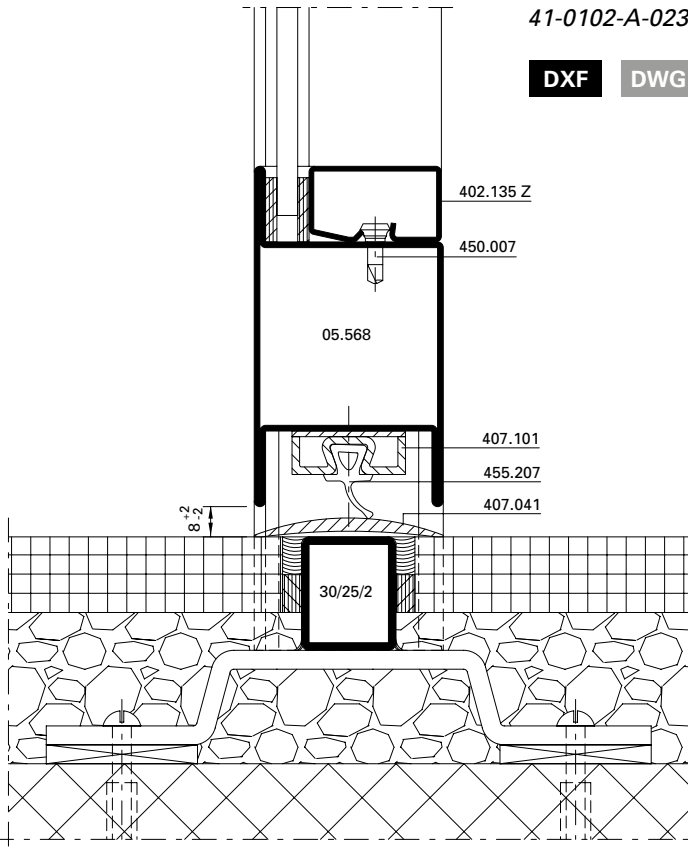

41-0102-A-024

DXF DWG

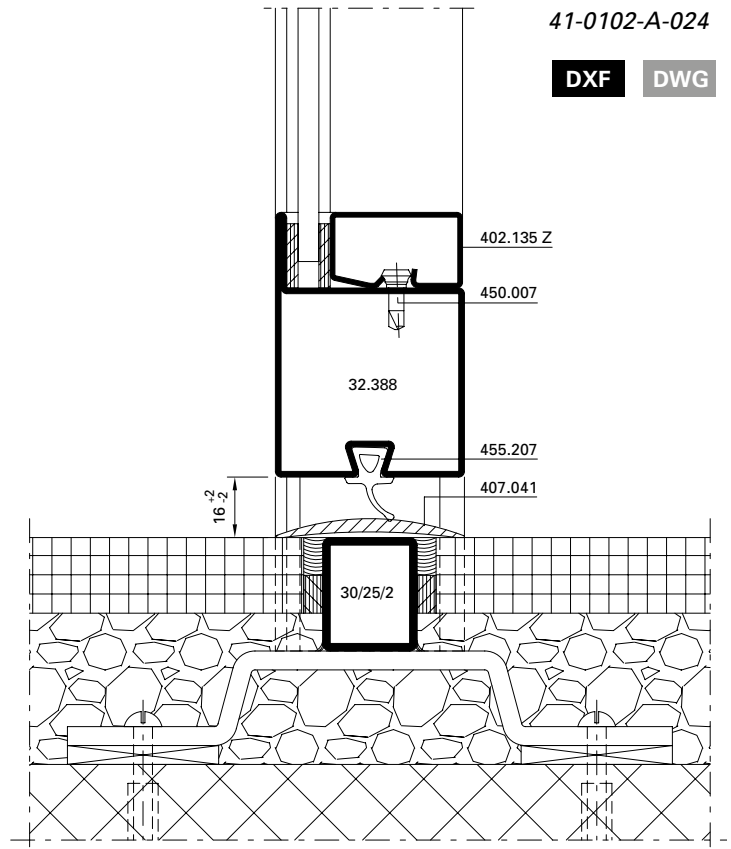

41-0102-A-025

DXF DWG

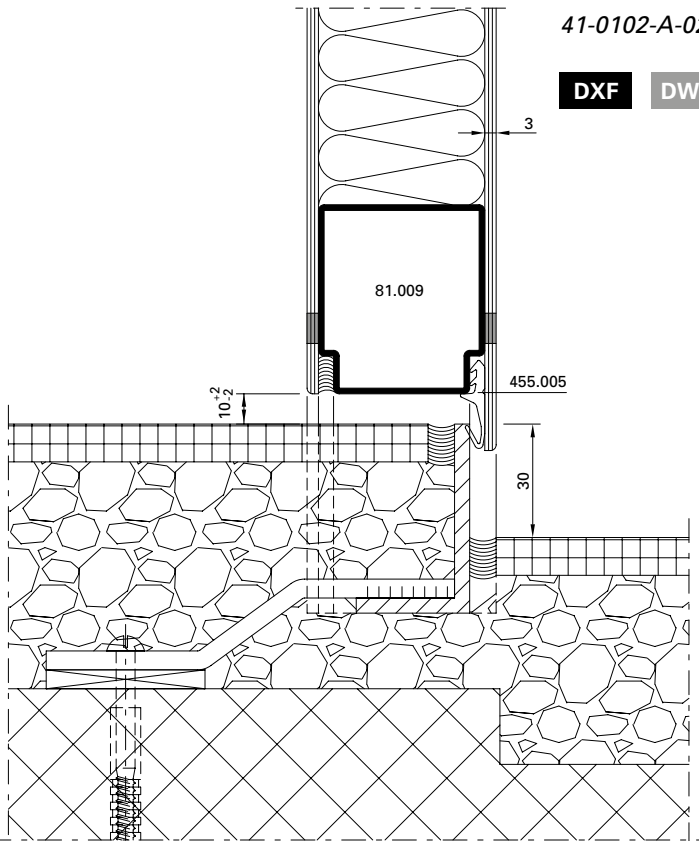

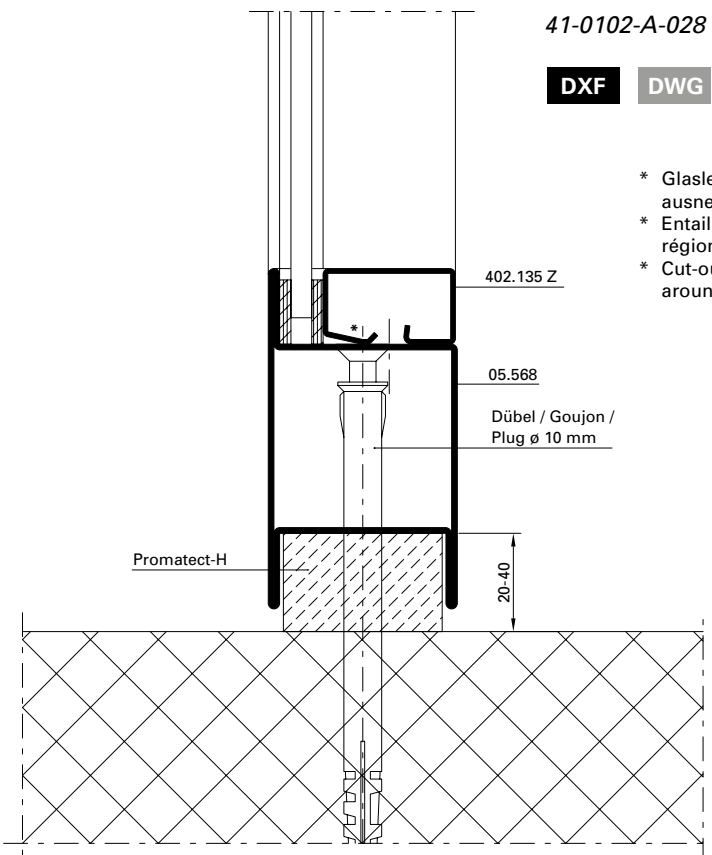
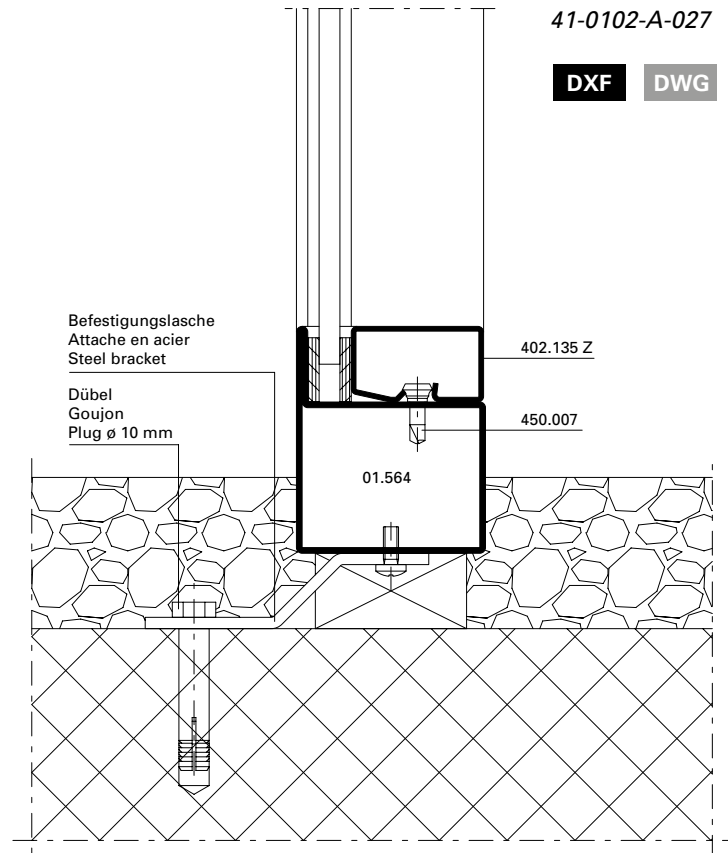
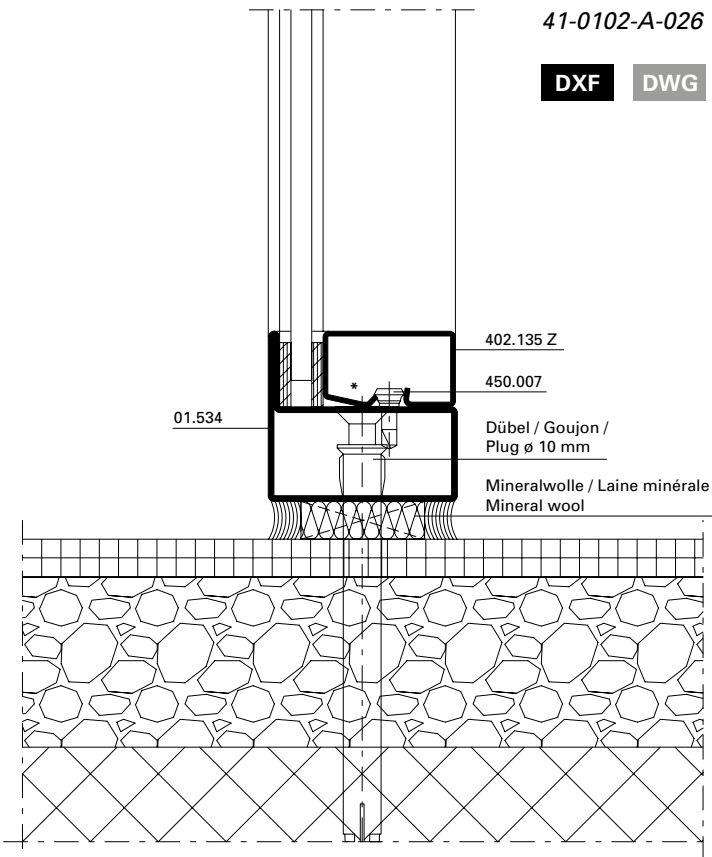

- * Glasleisten im Dübelbereich ausnehmen
- * Entailler la parclose dans la région de la douille
- * Cut-out in glazing bead around plug

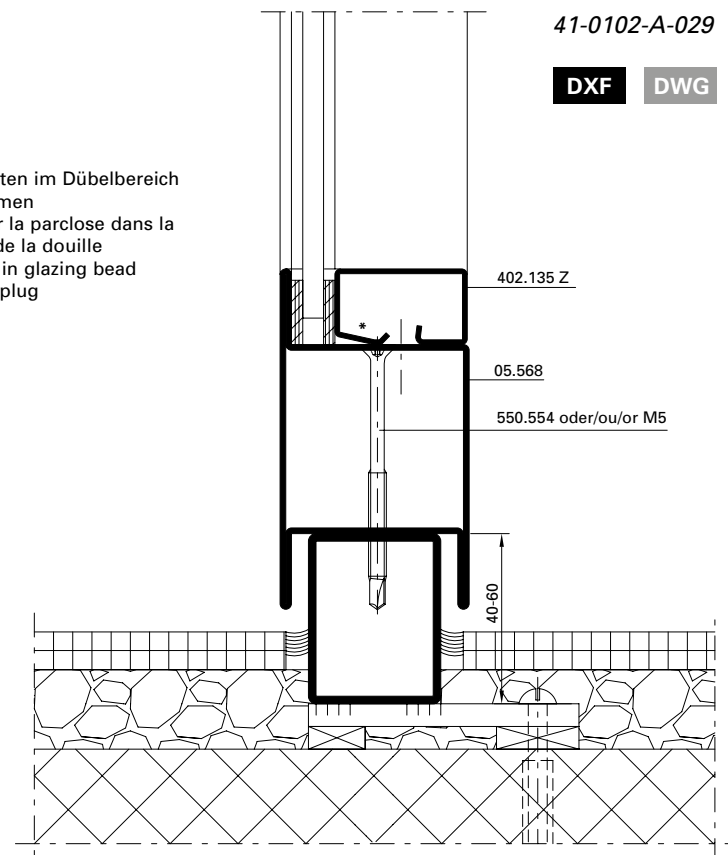

U_f-Werte
(nach EN ISO 10077-2:2018-01)

Valeurs U_f
(selon EN ISO 10077-2:2018-01)

U_f values
(according to
EN ISO 10077-2:2018-01)

Auf den folgenden Seiten finden Sie die U_f-Werte für die verschiedenen Anwendungen von Jansen-Economy 50 E30.

Vous trouverez les valeurs U_f pour les différentes applications Jansen-Economy 50 E30 dans les pages qui suivent.

On the following pages you will find the U_f values for the various applications for Jansen-Economy 50 E30.

Sie basieren auf folgenden Grundlagen:

Elles se basent sur les principes suivants:

They are based on the following:

Stahl

- Profile bandverzinkter Stahl, unbeschichtet
- Stahl-Glasleisten
- Trockenverglasung
- Nassverglasung

Acier

- Profilés en bande d'acier zingué, sans revêtement
- Parcloses en acier
- Vitrage à sec
- Vitrage à mastic

Steel

- Strip galvanised steel profiles, uncoated
- Steel glazing beads
- Glazing with dry glazing
- Glazing with sealing

Edelstahl

- Profile Edelstahl, blank
- Edelstahl-Glasleisten
- Trockenverglasung
- Nassverglasung

Acier Inox

- Profilés en acier Inox, brut
- Parcloses en acier Inox
- Vitrage à sec
- Vitrage à mastic

Stainless steel

- Stainless steel profiles, bright
- Stainless steel glazing beads
- Glazing with dry glazing
- Glazing with sealing

U_f-Werte
 (nach EN ISO 10077-2:2018-01)

Valeurs U_f
 (selon EN ISO 10077-2:2018-01)

U_f values
 (according to EN ISO 10077-2:2018-01)

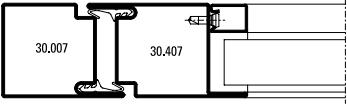
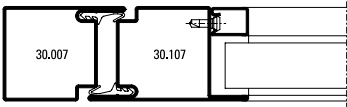
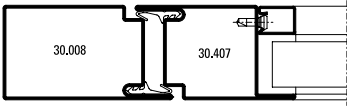
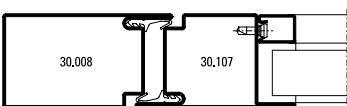
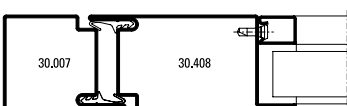
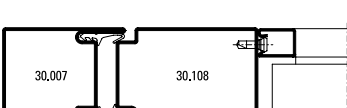
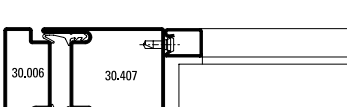
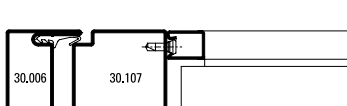
	Füllelementstärken Elements de remplissages Infill elements > 24 mm
	5,4 W/m²K
	5,4 W/m²K
	5,2 W/m²K
	5,2 W/m²K
	5,1 W/m²K
	5,2 W/m²K
	5,5 W/m²K
	5,5 W/m²K

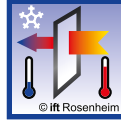
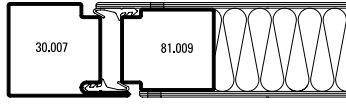
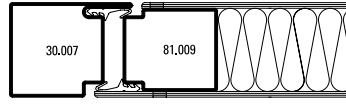
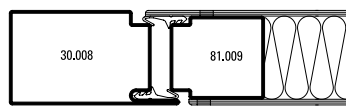
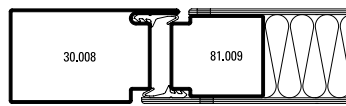
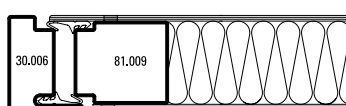
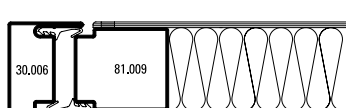
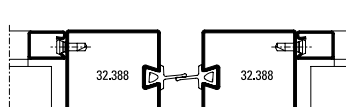
	Füllelementstärken Elements de remplissages Infill elements > 24 mm
	5,3 W/m²K
	5,3 W/m²K
	5,1 W/m²K
	5,1 W/m²K
	5,4 W/m²K
	5,4 W/m²K
	6,6 W/m²K

U_f-Werte
 (nach EN ISO 10077-2:2018-01)

Valeurs U_f
 (selon EN ISO 10077-2:2018-01)

U_f values
 (according to EN ISO 10077-2:2018-01)

	Füllelementstärken Elements de remplissages Infill elements > 24 mm
	5,6 W/m²K
	5,8 W/m²K
	5,6 W/m²K

	Füllelementstärken Elements de remplissages Infill elements > 24 mm
	7,3 W/m²K
	6,5 W/m²K
	6,0 W/m²K
	5,2 W/m²K
	4,9 W/m²K

U_f-Werte
 (nach EN ISO 10077-2:2018-01)

Valeurs U_f
 (selon EN ISO 10077-2:2018-01)

U_f values
 (according to EN ISO 10077-2:2018-01)

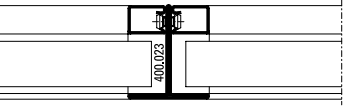
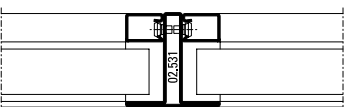
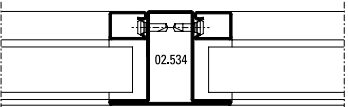
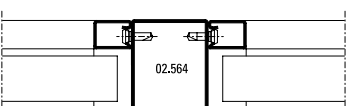
 <small>© ift Rosenheim</small>	Füllelementstärken Elements de remplissages Infill elements > 24 mm
	7,6 W/m²K
	7,2 W/m²K
	6,6 W/m²K
	6,2 W/m²K

U_f-Werte
 (nach EN ISO 10077-2:2018-01)

Valeurs U_f
 (selon EN ISO 10077-2:2018-01)

U_f values
 (according to EN ISO 10077-2:2018-01)

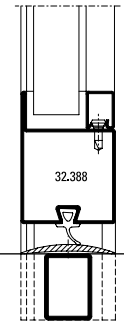
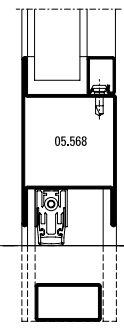
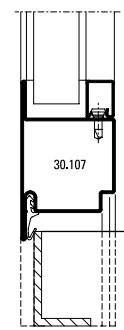
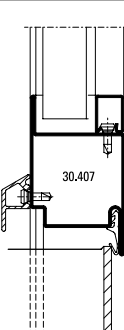
	Füllelementstärken Elements de remplissages Infill elements > 24 mm
	5,4 W/m ² K
	5,4 W/m ² K
	5,4 W/m ² K
	5,4 W/m ² K

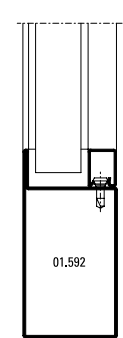
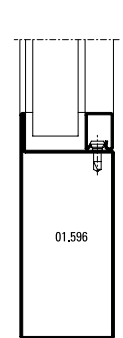
	Füllelementstärken Elements de remplissages Infill elements > 24 mm
	5,2 W/m ² K
	4,9 W/m ² K

U_f-Werte
 (nach EN ISO 10077-2:2018-01)

Valeurs U_f
 (selon EN ISO 10077-2:2018-01)

U_f values
 (according to EN ISO 10077-2:2018-01)

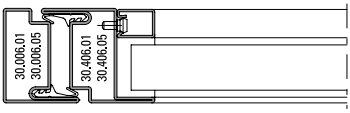
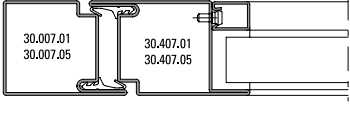
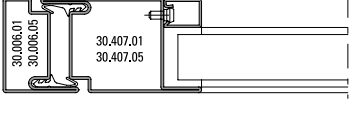
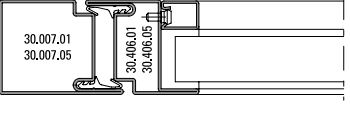
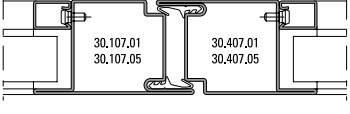

	Füllelementstärken Elements de remplissages Infill elements > 24 mm
	5,1 W/m²K
	4,4 W/m²K
	4,6 W/m²K
	4,8 W/m²K
	4,6 W/m²K

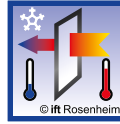
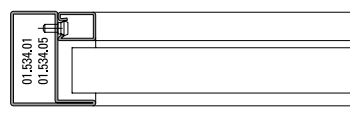
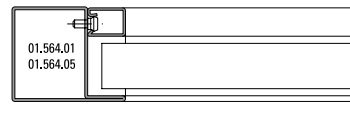
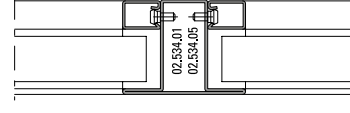
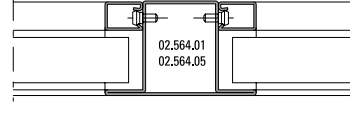
	Füllelementstärken Elements de remplissages Infill elements > 24 mm
	5,6 W/m²K
	5,0 W/m²K
	5,5 W/m²K
	5,0 W/m²K

Leistungseigenschaften nach EN 14351-1
Caractéristiques de performance selon EN 14351-1
Performance characteristics according to EN 14351-1

Jansen-Economy 50 E30
Jansen-Economy 50 E30
Jansen-Economy 50 E30

U_f-Werte
(nach EN ISO 10077-2:2018-01)

Valeurs U_f
(selon EN ISO 10077-2:2018-01)

U_f values
(according to EN ISO 10077-2:2018-01)



	<p>Füllelementstärken Elements de remplissages Infill elements</p> <p>> 24 mm</p>
	<p>4,6 W/m²K</p>