

Jansen-Economy 50 Türen

Türen aus Stahl und Edelstahl

Portes Jansen-Economy 50

Portes en acier et acier Inox

Jansen-Economy 50 doors

Doors in steel and stainless steel

Inhaltsverzeichnis**Sommaire****Content**

Jansen-Economy 50 Türen

Jansen-Economy 50 portes

Jansen-Economy 50 doors

SystemübersichtMerkmale
Leistungseigenschaften
Systemausführungen
Typenübersicht**Sommaire du système**Caractéristiques
Caractéristiques de performance
Exécutions de système
Sommaire des types**Summary of system**Characteristics
Performance characteristics
System versions
Summary of types**2**

**Profilsortiment in Stahl
und Edelstahl****Assortiment de profilé
en acier et acier Inox****Range of profiles in
steel and stainless steel****12**

BeispieleSchnittpunkte
Konstruktionsdetails
Anschlüsse am Bau**Exemples**Coupes de détails
Détails de construction
Raccords au mur**Examples**Section details
Construction details
Attachment to structure**18**

Leistungseigenschaften**Caractéristiques de
performance****Performance
characteristics****33**

Alle Ausführungen dieser Dokumentation haben wir sorgfältig und nach bestem Wissen zusammengestellt. Wir können aber keine Verantwortung für die Benutzung der vermittelten Vorschläge und Daten übernehmen. Wir behalten uns technische Änderungen ohne Vorankündigung vor.
Aktuelle Version auf www.jansen.com

Nous avons apporté le plus grand soin à l'élaboration de cette documentation. Cependant, nous déclinons toute responsabilité pour l'utilisation faite de nos propositions et de nos données.
Nous nous réservons le droit de procéder à des modifications techniques sans préavis.
Version actuelle sur www.jansen.com

All the information contained in this documentation is given to the best of our knowledge and ability. However, we decline all responsibility for the use made of these suggestions and data.
We reserve the right to effect technical modifications without prior warning.
Current version available at www.jansen.com

Jansen-Economy 50 Türen

- Stahlsystem für Türen und Festverglasungen
- Bautiefe 50 mm, innen und aussen flächenbündig
- Schmale Ansichtsbreiten: Rahmen und Flügel ab 105 mm Stulppartie 150 mm
- Ein- und zweiflüglige Türen, nach innen und aussen öffnend, mit Oberlicht oder Festverglasung kombinierbar
- Türflügel bis 1200 x 2500 mm (BxH), Flügelgewicht bis 230 kg
- Füllelementstärke von 5 bis 27 mm, Glaseinbau mittels Trocken- oder Nassverglasung
- Systemprüfungen nach Produktnorm EN 14351-1
- Stahlprofile blank oder bandverzinkt
- Grosses Sortiment an systemgeprüften Türbeschlägen
- Barrierefreie Schwellenausbildungen
- Geeignet für Pulver- und Nasslackbeschichtungen

Jansen-Economy 50 portes







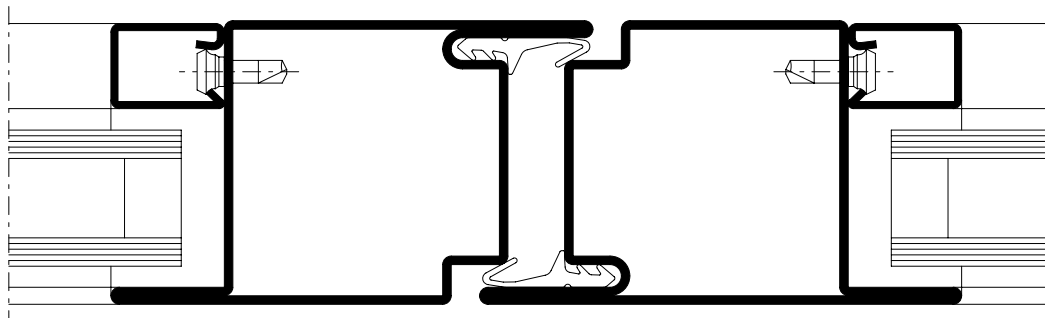



- Système en acier pour portes et vitrages fixes
- Profondeur de montage 50 mm, montage à fleur à l'intérieur et à l'extérieur
- Fines largeurs de face: Cadre et vantaux à partir de 105 mm Partie tête 150 mm
- Portes à un et deux vantaux, ouverture vers l'intérieur et vers l'extérieur, combinables avec imposte ou vitrage fixe
- Vantaux de porte jusqu'à 1200 x 2500 mm (LaxH), poids du vantail jusqu'à 230 kg
- Élément de remplissage de 5 à 27 mm d'épaisseur, Montage du vitrage à sec ou à silicone
- Contrôles des systèmes selon la norme produit EN 14351-1
- Profilés en acier brut ou galvanisé en continu
- Grand assortiment de ferrures de porte homologuées
- Formes de seuil sans barrière
- Convient aux revêtements par poudre ou peinture liquide

Jansen-Economy 50 doors

- Steel system for doors and fixed glazing
- 50 mm basic depth, flush-fitted on the inside and outside
- Narrow face widths: Frame and leaf from 105 mm Meeting stile assembly 150 mm
- Single and double-leaf doors, inward and outward-opening, can be combined with toplight or fixed glazing
- Door leaf up to 1200 x 2500 mm (WxH), leaf weight up to 230 kg
- Infill unit thickness of 5 to 27 mm, Glazing installed by means of dry or wet glazing
- System tests in accordance with the product standard EN 14351-1
- Raw finish or pre-galvanised steel profiles
- Large range of system-tested door fittings
- Easy-access thresholds
- Suitable for powder and wet paint coating





Norm	Eigenschaft Caractéristique Characteristic	Klassifizierung/Wert Classification / Valeur Classification / Value										
 EN 12210	Widerstandsfähigkeit bei Windlast Résistance à la pression du vent Resistance to wind load	npd	1 (400)	2 (800)	3 (1200)	4 (1600)	5 (2000)	Exxx (>2000)				
 EN 12208	Schlagregendichtheit Étanchéité à la pluie battante Watertightness	npd	1A (0)	2A (50)	3A (100)	4A (150)	5A (200)	6A (250)	7A (300)	8A (450)	9A (600)	Exxx (>750)
 EN ISO 10140	Schalldämmung R_w (C , C_{tr}) (dB) Isolation phonique R_w (C , C_{tr}) (dB) Sound insulation R_w (C , C_{tr}) (dB)	npd	bis R_w 44 dB (-2; -5) jusqu'à R_w 44 dB (-2; -5) up to R_w 44 dB (-2; -5)									
 EN ISO 10077-2	Wärmedurchgangskoeffizient U_f (W/(m ² ·K)) Transmission thermique U_f (W/(m ² ·K)) Thermal production U_f (W/(m ² ·K))	npd	ab 4,3 W/m ² ·K à partir de 4,3 W/m ² ·K from 4,3 W/m ² ·K									
 EN 12207	Luftdurchlässigkeit Perméabilité à l'air Air permeability	npd	1 (150)		2 (300)		3 (600)		4 (600)			
 EN 1522	Durchschusshemmung Résistance aux balles Bullet proofing	npd	FB1	FB2	FB3	FB4	FB5	FB6	FB7	FSG		
 EN 12400	Dauerfunktionsprüfung Durabilité mécanique Mechanical durability		D	1 5'000	2 10'000	3 20'000	4 50'000	5 100'000	6 200'000	7 500'000	8 1'000'000	
 EN 14351-1	Fähigkeit zur Freigabe Aptitude au déblocage Ability to release	npd	Anforderung erfüllt Exigence remplie Requirement satisfied									
 EN 1192	Klassifizierung der Festigkeitsanforderungen Classification des exigences de résistance méc. Classification of strength requirements	npd	1		2		3		4			
 DIN 18040	Barrierefreiheit Absence d'entrave au passage Barrier-free		Schwellenlose Ausführung Exécution sans seuil Execution without threshold									

npd = keine Leistung festgestellt
(no performance determined)

npd = Aucune performance déterminée
(no performance determined)

npd = no performance determined

Zur Erreichung der maximalen Leistungswerte sind die Gutachtlichen Stellungnahmen zu beachten.

Les prescriptions de l'avis d'expertise doivent être respectés pour obtenir les valeurs de performance maximales.

To achieve the maximum performance values, the provisions of appraisal report must be adhered to.

Elementgrößen
 (Empfehlung für CE-Kennzeichnung)

Dimensions des éléments
 (Recommandation pour le label CE)

Size of elements
 (Recommendation for CE marking)

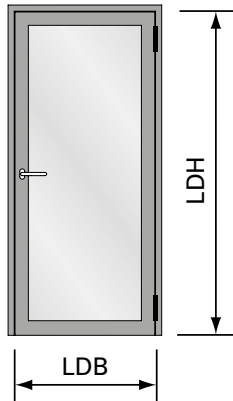

LDB	Lichte Durchgangsbreite max. 1200 mm min. 490 mm
LDH	Lichte Durchgangshöhe max. 2500 mm min. 1900 mm
Flügelgewicht max. 230 kg	

LDB	Largeur vide lumière max. 1200 mm min. 490 mm
LDH	Hauteur vide lumière max. 2500 mm min. 1900 mm
Poids de vantail max. 230 kg	

LDB	Clear opening width max. 1200 mm min. 490 mm
LDH	Clear opening height max. 2500 mm min. 1900 mm
Weight of leaf max. 230 kg	

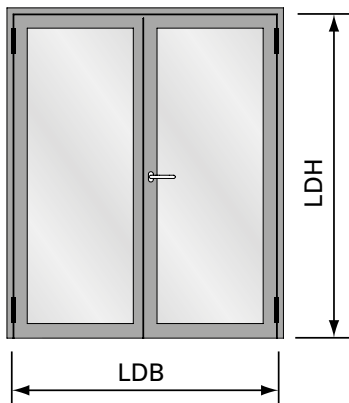

LDB	Lichte Durchgangsbreite max. 2400 mm min. 1000 mm
LDH	Lichte Durchgangshöhe max. 2500 mm min. 1900 mm
Flügelgewicht max. 230 kg	

LDB	Largeur vide lumière max. 2400 mm min. 1000 mm
LDH	Hauteur vide lumière max. 2500 mm min. 1900 mm
Poids de vantail max. 230 kg	

LDB	Clear opening width max. 2400 mm min. 1000 mm
LDH	Clear opening height max. 2500 mm min. 1900 mm
Weight of leaf max. 230 kg	

Jansen Docu Center

Die Plattform zum effizienten Arbeiten mit Jansen Dokumentationen. Im Jansen Docu Center stehen alle Produktinformationen jederzeit digital in der aktuellsten Version zur Verfügung: von Architekten-Informationen über Bestell- und Fertigungskatalogen bis hin zu Anleitungen und Prospekten sowie Videos.

Die Inhalte können einfach und schnell aufgerufen werden. Ein für den Anwender komfortables papierloses Arbeiten, das zahlreiche Vorteile bietet.

Download CAD Daten

DXF

DWG

Sie können die Zeichnungen in den Formaten DXF und/oder DWG herunterladen. Klicken Sie auf das entsprechende Icon und der Download erfolgt.

Die Hinweise «Artikelbibliothek/Türbeschläge/Fensterbeschläge» bedeuten, dass Sie mit einem Klick die gesamte Artikelbibliothek des entsprechenden Systems herunterladen (Profile, Beschläge, Glasleisten, Zubehör etc.).

Info und Beratung

Gerne beraten wir Sie persönlich und stehen Ihnen bei Fragen zur Verfügung. Bitte schreiben Sie uns Ihre Anliegen an: info@jansen.com

Jansen Docu Center

La plate-forme pour travailler efficacement avec les documentations Jansen. Le Jansen Docu Center met à votre disposition les informations sur les produits, en format numérique et dans une version actualisée: des catalogues de commande et de fabrication aux instructions et prospectus, en passant par les informations destinées aux architectes et vidéos.

Les contenus sont facilement et rapidement accessibles. Une manière de travailler confortable et offrant de nombreux avantages.

Télécharger fichiers DAO

DXF

DWG

Vous pouvez télécharger les dessins aux formats DXF et/ou DWG. Cliquez sur l'icône correspondante et le téléchargement s'effectuera.

Les indications «Bibliothèque des articles/Ferures de porte/Ferrures de fenêtres» signifie que vous téléchargez la totalité de la bibliothèque des articles du système donné (profilés, ferrures, parclofes, accessoires etc.).

Info et conseils

Nous vous conseillons volontiers individuellement et sommes à votre disposition si vous avez des questions à poser. Veuillez nous envoyer votre requête à: info@jansen.com

Jansen Docu Center

The platform for working efficiently with Jansen documentation. The latest version of all the product information is available digitally at any time in the Jansen Docu Center – from order and fabrication manuals to architect information, instructions and brochures and videos.

The content can be retrieved quickly and easily. The user can work conveniently without paper, which has numerous benefits.

Download CAD files

DXF

DWG

You can download the drawings in DXF and/or DWG format. Click on the relevant icon to begin the download.

The items «Article library/Door fittings/Window fittings» means that you download the entire article library for the corresponding system with one click (profiles, fittings, glazing beads, accessories etc.).

Information and advice

We would be delighted to provide you with advice in person and are available to answer any questions you may have. Please write to us with your queries at: info@jansen.com



Jansen-Economy 50 Türen Edelstahl

- Nichtisoliertes Edelstahlsystem für Türen, Fenster und Festverglasungen
- Bautiefe 50 mm, innen und aussen flächenbündig
- Schmale Ansichtsbreiten: Rahmen und Flügel ab 107,5 mm, Stulppartie 155 mm
- Werkstoff 1.4307 (AISI 304L) mit guter Korrosionsbeständigkeit, geeignet für den universellen Bereich
- Werkstoff 1.4304 (AISI 316L) mit hoher Korrosionsbeständigkeit, geeignet für den Einsatz in Küstennähe, in Industriegebieten, im Hygienebereich, in Strassennähe (beständig gegen Streusalz)
- Ausführung blank oder geschliffen (Korn 220-240)

Portes Jansen-Economy 50 acier Inox

- Système en acier Inox non-isolées pour portes et vitrages fixes
- Profondeur de montage 50 mm, montage à fleur à l'intérieur et à l'extérieur
- Fines largeurs de face: Cadre et vantaux à partir de 107,5 mm, partir tête 155 mm
- Matériau 1.4307, caractérisé par une bonne résistance à la corrosion, conçu pour un usage universel
- Matériau 1.4404, caractérisé par une très bonne résistance à la corrosion, conçu pour le littoral, les zones industrielles, près de routes (grâce à la résistance au sel d'épandage), le domaine de l'hygiène
- Exécution brut ou polie (grain 220 à 240)

Jansen-Economy 50 stainless steel doors

- Non-insulated stainless steel system for doors and fixed glazing
- 50 mm basic depth, flush-fitted on the inside and outside
- Narrow face widths: Frame and leaf from 107.5 mm, meeting stile assembly 155 mm
- Material 1.4307 with good corrosion resistance, suitable for universal use
- Material 1.4404 with high corrosion resistance, suitable for use in coastal areas, industrial areas, in areas with strict hygiene requirements, near roads (resistance to grit)
- Execution bright or polished (grain 220-240)



Fluchttürsysteme

- Verschlussystem für Notausgangstüren nach EN 179
- Verschlussystem für Paniktüren nach EN 1125
- Barrierefreie Türen ohne Schwelle für behindertengerechtes Bauen
- Ein- und zweiflügelige Türen nach innen und aussen öffnend
- Türflügelgrößen bis 1200 x 2500 mm und Flügelgewicht bis 230 kg

Systèmes de porte de secours

- Système de fermeture pour portes de secours selon EN 179
- Système de fermeture pour portes panique selon EN 1125
- Portes sans seuil pour faciliter l'accès aux personnes handicapées
- Portes à un/deux vantaux à ouverture vers l'intérieur et l'extérieur
- Dimensions de vantail de porte jusqu'à 1200 x 2500 mm et poids de vantail jusqu'à 230 kg

Emergency exit systems

- Closing system for emergency exit doors in accordance with EN 179
- Closing system for panic doors in accordance with EN 1125
- Barrier-free doors without threshold for accessible buildings
- Single and double-leaf doors, outward and inward-opening
- Door leaf sizes up to 1200 x 2500 mm and leaf weight up to 230 kg

Jansen-Economy 50 Fingerschutzüren

- Keine Quetsch- und Scherstellen nach DIN 18650
- Wartungsarme Bandlager unten und oben
- Geeignet für Gebäude mit starkem Publikumsverkehr
- Geprüft nach EN 14351-1

Portes anti-pince-doigts Jansen-Economy 50

- Absence de zones d'écrasement et de cisaillement selon DIN 18650
- Paliers de paumelle inférieur et supérieur exigeant peu de maintenance
- Adapté à des bâtiments publics fortement fréquentés
- Contrôlé selon la norme EN 14351-1

Jansen Economy 50 anti-finger-trap doors

- No crushing and shearing points as per DIN 18650
- Low-maintenance hinge bush at top and bottom
- Suitable for buildings subject to frequent use by the public
- Tested in accordance with EN 14351-1

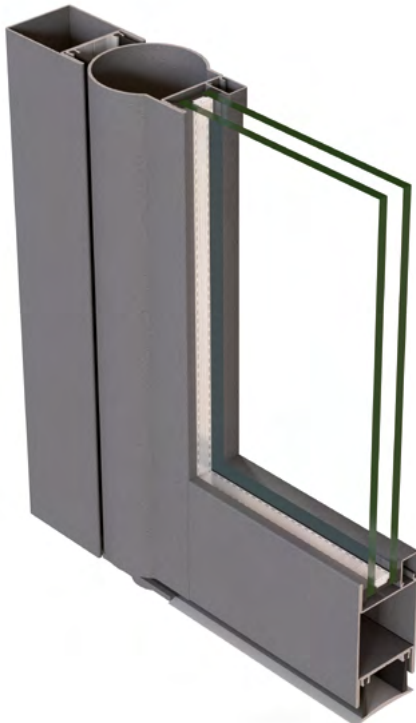



Jansen-Economy 50 Pendeltüre

- Keine Quetsch- und Scherstellen
- Flügelgrößen bis 1400 x 3000 mm
- Flügelgewicht bis 230 kg
- Wartungsarme Bandlager unten und oben

Porte va-et-vient Jansen Economy 50

- Absence de zones d'écrasement ou de cisaillement
- Dimensions de vantail jusqu'à 1400 x 3000 mm
- Poids de vantail jusqu'à 230 kg
- Paliers de paumelle inférieur et supérieur exigeant peu de maintenance

Jansen Economy 50 swing doors

- No crushing and shearing points
- Leaf sizes up to 1400 x 3000 mm
- Leaf weight up to 230 kg
- Low-maintenance hinge bush at top and bottom

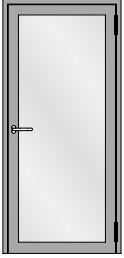

Einflügelige Türe
Porte à un vantail
Single leaf door

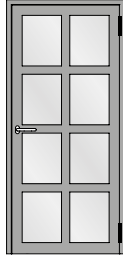

Einflügelige Türe mit Riegel
Porte à un vantail avec traverse
Single leaf door with transom

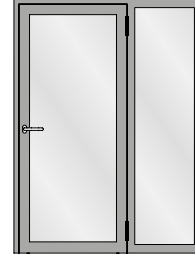

Einflügelige Türe mit Seitenteil
Porte à un vantail avec partie latérale
Single leaf door with side light

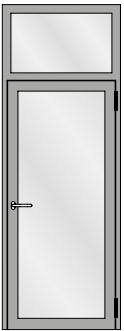

Einflügelige Türe mit Oberlicht
Porte à un vantail avec imposte
Single leaf door with top light

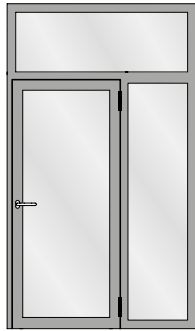

Einflügelige Türe mit Seitenteil und Oberlicht
Porte à un vantail avec partie latérale et imposte
Single leaf door with side light and top light

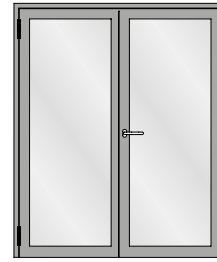

Zweiflügelige Türe
Porte à deux vantaux
Double leaf door

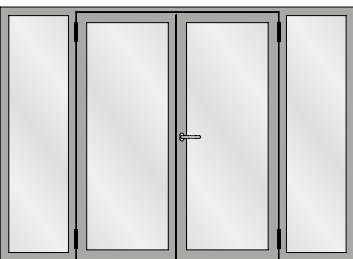

Zweiflügelige Türe mit zwei Seitenteilen
Porte à deux vantaux avec deux parties latérales
Double leaf door with two side lights

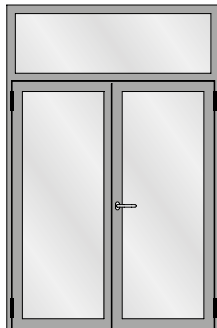

Zweiflügelige Türe mit Oberlicht
Porte à deux vantaux avec imposte
Double leaf door with top light

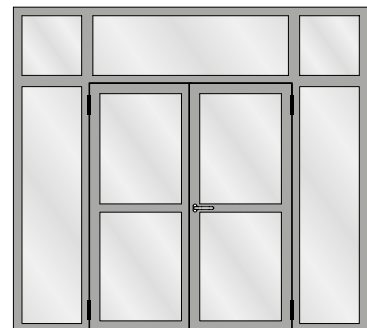

Zweiflügelige Türe mit zwei Seitenteilen
und Oberlichtern
Porte à deux vantaux avec deux parties
latérales et impostes
Double leaf door with two side lights and
top lights

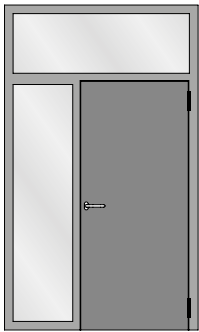

Verblechte Türe mit Seitenteil und Oberlicht
 Porte tôle à un vantail avec avec partie latérale et imposte
 Sheet metal single leaf door with side light and top light

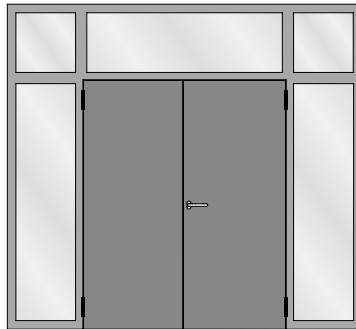

Verblechte zweiflügelige Türe mit zwei Seitenteilen und Oberlichtern
 Porte tôle à deux vantaux avec deux parties latérales et impostes
 Sheet metal double leaf door with two side lights and top lights

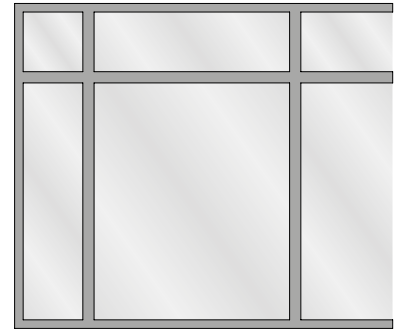

Festverglasung
 Vitrage fixe
 Fixed glazing

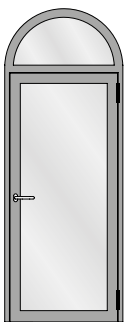

Einflügelige Türe mit Rundbogen-Oberlicht
 Porte à un vantail avec imposte demi-ronde
 Single leaf door with round arched top light

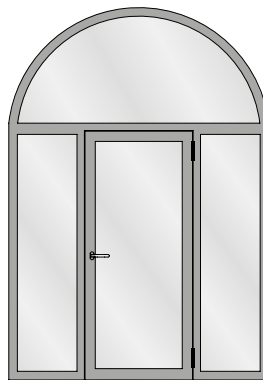

Einflügelige Türe mit zwei Seitenteilen und Rundbogen-Oberlicht
 Porte à un vantail avec deux parties latérales et imposte demi-ronde
 Single leaf door with two side lights and round arched top light

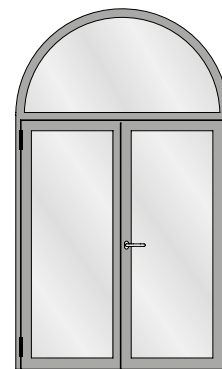

Zweiflügelige Türe mit Rundbogen-Oberlicht
 Porte à deux vantaux avec imposte demi-ronde
 Double leaf door with round arched top light

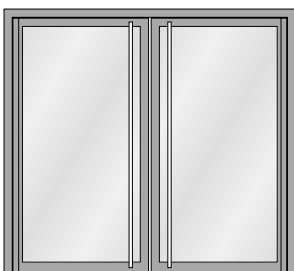

Pendeltüre
 Porte va-et-vient
 Double action door

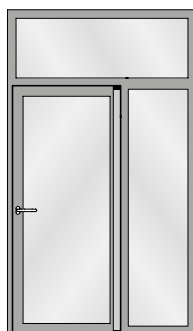

Fingerschutztüre
 Porte anti-pince-doigts
 Anti-finger-trap door

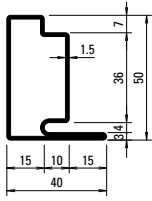

30.006
30.006 Z
 30.006.01
 30.006.05

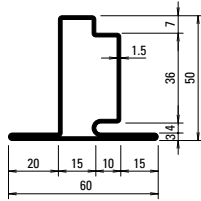

30.106
30.106 Z
 30.106.01*
 30.106.05*

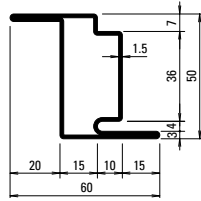

30.406
30.406 Z
 30.406.01*
 30.406.05*

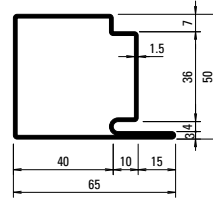

30.007
30.007 Z
 30.007.01
 30.007.05

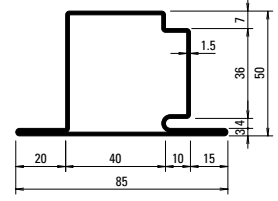

30.107
30.107 Z
 30.107.01
 30.107.05

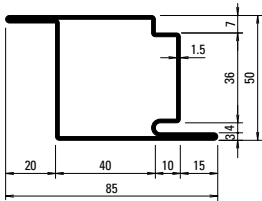

30.407
30.407 Z
 30.407.01
 30.407.05

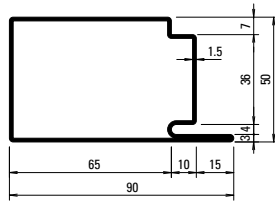

30.008
30.008 Z

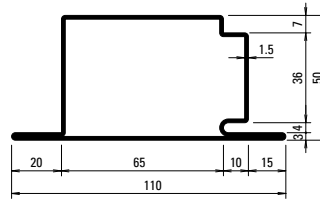

30.108
30.108 Z

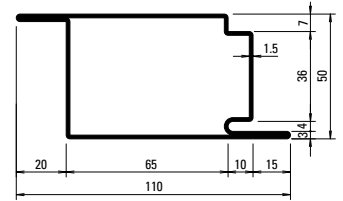

30.408
30.408 Z

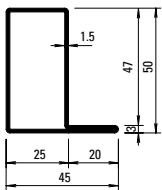

01.534
01.534 Z
 01.534.01
 01.534.05

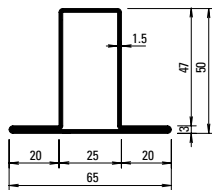

02.534
02.534 Z
 02.534.01
 02.534.05

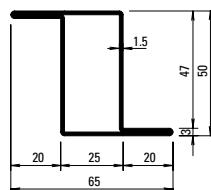

03.534
03.534 Z
 03.534.01*
 03.534.05*

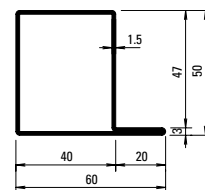

01.564
01.564 Z
 01.564.01
 01.564.05

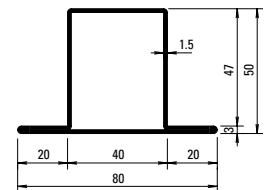

02.564
02.564 Z
 02.564.01
 02.564.05

* Auslaufende Profile

* Profilés en fin de série

* Discontinued profiles

Gewichte für die Edelstahl-Profile
 siehe Seite 15

Poids pour profilés en acier Inox
 voir page 15

Weights for stainless steel profiles
 see page 15

Profil-Nr.	G kg/m	F cm ²	I _x cm ⁴	W _x cm ³	I _y cm ⁴	W _y cm ³	U m ² /m
30.006	2,330	2,97	9,31	3,00	3,96	1,62	0,190
30.106	2,830	3,60	10,87	3,19	7,52	2,41	0,230
30.406	2,830	3,60	13,79	5,31	7,52	2,41	0,230
30.007	2,960	3,77	14,23	4,78	16,30	4,64	0,240
30.107	3,450	4,40	16,09	4,97	24,97	5,64	0,280
30.407	3,450	4,40	18,48	7,16	24,97	5,64	0,280
30.008	3,590	4,57	19,06	6,59	40,34	8,68	0,290

Profil-Nr.	G kg/m	F cm ²	I _x cm ⁴	W _x cm ³	I _y cm ⁴	W _y cm ³	U m ² /m
30.108	4,080	5,20	21,15	6,76	56,20	9,84	0,330
30.408	4,080	5,20	23,17	9,02	56,20	9,84	0,330
01.534	2,130	2,71	9,35	3,11	4,78	1,73	0,185
02.534	2,590	3,30	10,99	3,30	8,56	2,63	0,224
03.534	2,590	3,30	10,99	3,30	8,56	2,63	0,224
01.564	2,490	3,17	12,10	4,12	11,20	3,25	0,216
02.564	2,950	3,75	13,90	4,31	17,60	4,40	0,255

Profilübersicht
Sommaire des profilés
Summary of profiles

Jansen-Economy 50 Türen
 Jansen-Economy 50 portes
 Jansen-Economy 50 doors

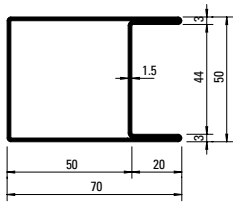

04.568
04.568 Z

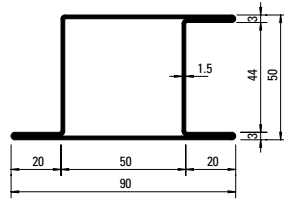

05.568
05.568 Z
 05.568.01
 05.568.05

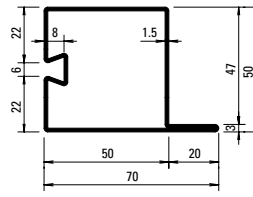

32.388
32.388 Z

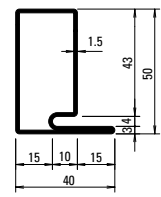

30.021

Gewichte für die Edelstahl-Profile
 siehe Seite 15

Poids pour profilés en acier Inox
 voir page 15

Weights for stainless steel profiles
 see page 15

Oberfläche/Werkstoff

Artikel-Nr.

ohne Zusatz = blank

mit Z = bandverzinkter Stahl

Werkstoff 1.4404 (AISI 316L)

mit 01 = blank

mit 03 = geschliffen, Korn 220-240

Werkstoff 1.4307 (AISI 304L)

mit 05 = blank

mit 07 = geschliffen, Korn 220-240

Edelstahl geschliffen auf Anfrage

Surface/Matériau

No. d'article

sans supplément = brut

avec Z = bande d'acier zinguée

Matériau 1.4404 (AISI 316L)

avec 01 = brut

avec 03 = polies, grain 220-240

Matériau 1.4307 (AISI 304L)

avec 05 = brut

avec 07 = polies, grain 220-240

Acier Inox polie sur demande

Surface/Material

Part no.

without addition = bright

with Z = strip galvanised steel

Material 1.4404 (AISI 316L)

with 01 = bright

with 03 = polished, grain 220-240

Material 1.4307 (AISI 304L)

with 05 = bright

with 07 = polished, grain 220-240

Stainless steel polished on request

Profil-Nr.	G kg/m	F cm ²	I _x cm ⁴	W _x cm ³	I _y cm ⁴	W _y cm ³	U m ² /m
04.568	3,190	4,06	17,76	7,11	21,77	6,20	0,275
05.568	3,620	4,65	20,62	7,37	32,39	6,55	0,315
32.388	2,940	3,74	14,10	4,89	18,50	4,56	0,254
30.021	2,220	2,83	9,48	3,10	3,81	1,59	0,193

Profilübersicht
Sommaire des profilés
Summary of profiles

Jansen-Economy 50 Türen
 Jansen-Economy 50 portes
 Jansen-Economy 50 doors

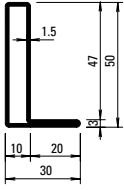

01.531
01.531 Z

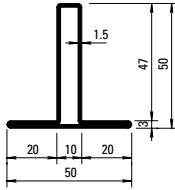

02.531
02.531 Z

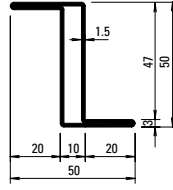

03.531
03.531 Z

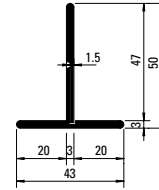

400.023
400.023 Z

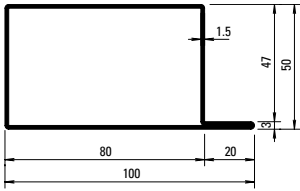

01.592
01.592 Z

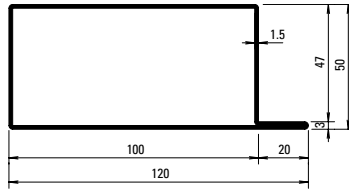

01.596
01.596 Z*

Artikelbibliothek
 Bibliothèque des articles
 Article library

DXF **DWG**

* Auslaufende Profile

* Profilés en fin de série

* Discontinued profiles

Oberfläche/Werkstoff

Artikel-Nr.

ohne Zusatz = blank

mit Z = bandverzinkter Stahl

Werkstoff 1.4404 (AISI 316L)

mit 01 = blank

mit 03 = geschliffen, Korn 220-240

Werkstoff 1.4307 (AISI 304L)

mit 05 = blank

mit 07 = geschliffen, Korn 220-240

Edelstahl geschliffen auf Anfrage

Surface/Matériau

No. d'article

sans supplément = brut

avec Z = bande d'acier zinguée

Matériau 1.4404 (AISI 316L)

avec 01 = brut

avec 03 = polies, grain 220-240

Matériau 1.4307 (AISI 304L)

avec 05 = brut

avec 07 = polies, grain 220-240

Acier Inox polie sur demande

Surface/Material

Part no.

without addition = bright

with Z = strip galvanised steel

Material 1.4404 (AISI 316L)

with 01 = bright

with 03 = polished, grain 220-240

Material 1.4307 (AISI 304L)

with 05 = bright

with 07 = polished, grain 220-240

Stainless steel polished on request

Profil-Nr.	G kg/m	F cm ²	I _x cm ⁴	W _x cm ³	I _y cm ⁴	W _y cm ³	U m ² /m
01.531	1,770	2,26	6,55	2,11	1,42	0,67	0,155
02.531	2,240	2,86	8,00	2,31	3,26	1,30	0,195
03.531	2,240	2,85	10,63	4,25	3,25	1,30	0,194
400.023	2,060	2,62	6,63	1,87	1,91	0,88	0,182

Profil-Nr.	G kg/m	F cm ²	I _x cm ⁴	W _x cm ³	I _y cm ⁴	W _y cm ³	U m ² /m
01.592	3,430	4,37	19,3	6,86	46,9	8,8	0,296
01.596	3,900	4,97	22,9	8,25	77,2	12,3	0,336

Profilübersicht
Sommaire des profilés
Summary of profiles

Jansen-Economy 50 Türen
 Jansen-Economy 50 portes
 Jansen-Economy 50 doors

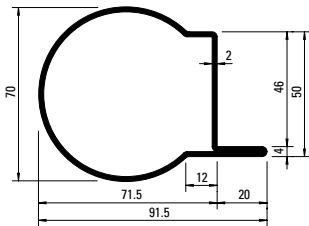

60.153**

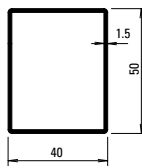

400.048
400.048 Z

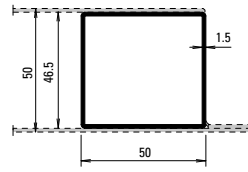

400.049
400.049 Z

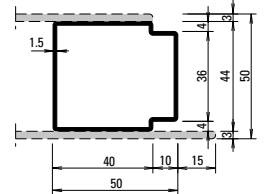

81.009
81.009 Z

Profil-Nr.	G kg/m	F cm ²	I _x cm ⁴	W _x cm ³	I _y cm ⁴	W _y cm ³	U m ² /m
60.153	4,220	5,38	42,81	9,08	30,36	7,91	0,275
81.009	2,090	2,67	7,79	3,54	9,63	3,76	0,182
400.048	2,050	2,58	9,46	3,78	6,70	3,35	0,177
400.049	2,200	2,77	10,61	4,24	9,49	4,08	0,190

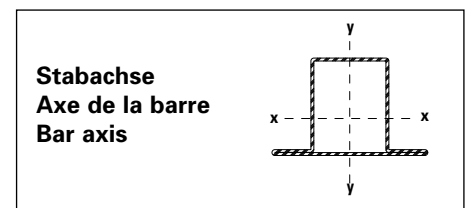

Gewichte für Edelstahl-Profile

.01/.03 = Werkstoff 1.4404 (AISI 316L)
 .05/.07 = Werkstoff 1.4307 (AISI 304L)

30.006.01	=	2,232 kg/m
30.106.01	=	2,694 kg/m
30.406.01	=	2,694 kg/m
30.007.01	=	2,832 kg/m
30.107.01	=	3,288 kg/m
30.407.01	=	3,288 kg/m
01.534.01	=	2,153 kg/m
02.534.01	=	2,622 kg/m
03.534.01	=	2,622 kg/m
01.564.01	=	2,513 kg/m
02.564.01	=	2,975 kg/m
05.568.01	=	3,672 kg/m

Poids pour profilés en acier Inox

.01/.03 = matériau 1.4404 (AISI 316L)
 .05/.07 = matériau 1.4307 (AISI 304L)

30.006.05	=	2,204 kg/m
30.106.05	=	2,660 kg/m
30.406.05	=	2,660 kg/m
30.007.05	=	2,797 kg/m
30.107.05	=	3,247 kg/m
30.407.05	=	3,247 kg/m
01.534.05	=	2,126 kg/m
02.534.05	=	2,589 kg/m
03.534.05	=	2,589 kg/m
01.564.05	=	2,481 kg/m
02.564.05	=	2,938 kg/m
05.568.05	=	3,626 kg/m

Weights for stainless steel profiles

.01/.03 = material 1.4404 (AISI 316L)
 .05/.07 = material 1.4307 (AISI 304L)

** Länge ca. 5 - 5,5 m
 ** Longueur env. 5 - 5,5 m
 ** Length approx. 5 - 5.5 m

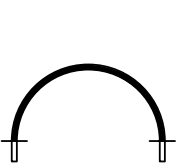
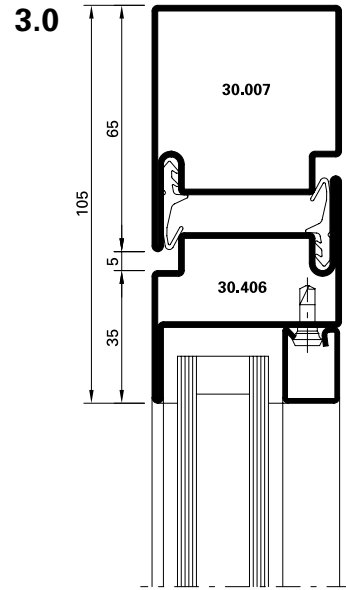
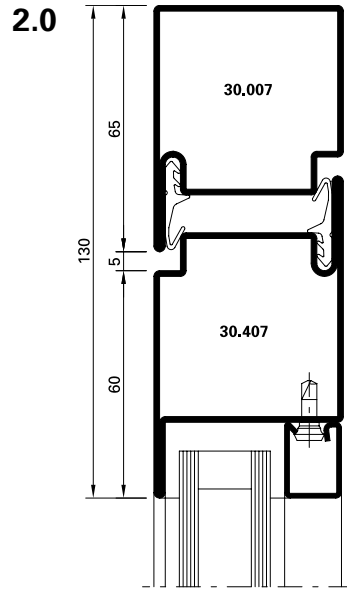
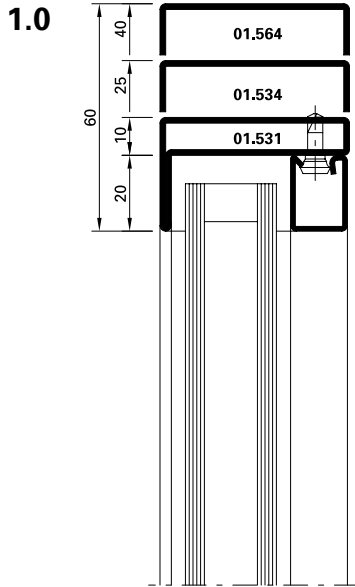
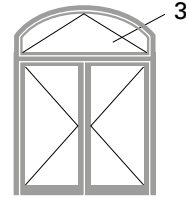
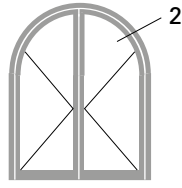
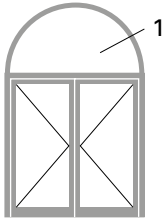

Halbrundbogen
 Arc semi-circulaire
 Semi-circular arch

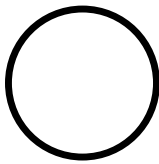

Rundbogen
 Arc en plein centre
 Round arch

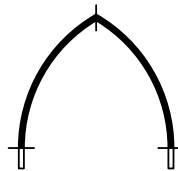

Spitzbogen
 Arc en ogive
 Gothic arch



Stichbogen
 Arc bombé
 Segmented arch



Korbbogen
 Anse de panier
 Oval arch

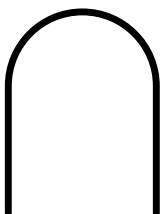

Halbrundbogen mit Schenkel
 Arc surhaussé prolongée
 Semi-circular arch with side extension

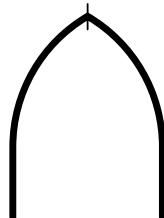

Spitzbogen mit Schenkel
 Arc en ogive prolongée
 Gothic arch with side extension

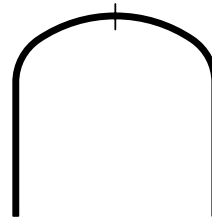



Korbbogen mit Schenkel
 Anse de panier prolongée
 Oval arch with side extension

Bogentüren
Portes cintrées
Arched doors

Jansen-Economy 50 Türen
 Jansen-Economy 50 portes
 Jansen-Economy 50 doors

Profil Profilé Profile	Min. Radius Rayon min. Min. radius R	
------------------------------	---	--

	blank	verzinkt
	brut	zinguée
	bright	galvanised
	mm	mm
01.531	350	
01.534	400	800
01.564	650	1050
01.592	1100	

	blank	verzinkt
	brut	zinguée
	bright	galvanised
	mm	mm
02.531	350	600
02.534	400	800
02.564	650	1050
400.023		800

	blank	verzinkt
	brut	zinguée
	bright	galvanised
	mm	mm
03.531	600	
03.534	500	800

	blank	verzinkt
	brut	zinguée
	bright	galvanised
	mm	mm
04.568	850	

	blank	verzinkt
	brut	zinguée
	bright	galvanised
	mm	mm
05.568	850	1250

	blank	verzinkt
	brut	zinguée
	bright	galvanised
	mm	mm
400.048	600	900
400.049	750	750
81.009	1050	

Profil Profilé Profile	Min. Radius Rayon min. Min. radius R	
------------------------------	---	--

	blank	verzinkt
	brut	zinguée
	bright	galvanised
	mm	mm
30.006	500	500
30.007	550	550

	blank	verzinkt
	brut	zinguée
	bright	galvanised
	mm	mm
30.106	700	700
30.107	750	750

	blank	verzinkt
	brut	zinguée
	bright	galvanised
	mm	mm
30.406	700	700
30.407	750	750

Stahl-Glasleisten Parcloses en acier Steel glazing beads	Min. Radius Rayon min. Min. radius R
--	---

	blank	verzinkt
	brut	zinguée
	bright	galvanised
	mm	mm
62.507 Z	300	
62.508 Z	300	
62.509 Z	300	

Stahl-Glasleisten Parcloses en acier Steel glazing beads	Min. Radius Rayon min. Min. radius R
--	---

	blank	verzinkt
	brut	zinguée
	bright	galvanised
	mm	mm
402.112 Z	500	
402.115 Z	500	
402.120 Z	600	
402.125 Z	750	
402.130 Z	1000	
402.135 Z	1500	

Aluminium-Glasleisten Parcloses en aluminium Aluminium glazing beads	Min. Radius Rayon min. Min. radius R
--	---

	blank	verzinkt
	brut	zinguée
	bright	galvanised
	mm	mm
404.109	400	
404.112	400	
404.115	400	
404.120	400	
404.125	450	
404.130	500	
404.135	600	

	blank	verzinkt
	brut	zinguée
	bright	galvanised
	mm	mm
405.110	500	
405.115	500	
405.120	500	
405.125	800	
405.130	1000	
405.135	1000	
406.903	500	
406.905	500	
406.907	500	
406.909	600	

Biegen von Edelstahl-Profilen auf Anfrage!

Die Radien-Angaben beziehen sich auf die langjährige Erfahrung und Fertigung im Hause Jansen.

Profilés acier Inox sur demande!

Les rayons indiqués se fondent sur la longue expérience et la fabrication au sein de la maison Jansen.

Stainless steel profiles on request!

The radii specifications are based on the many years of experience Jansen has in fabrication.

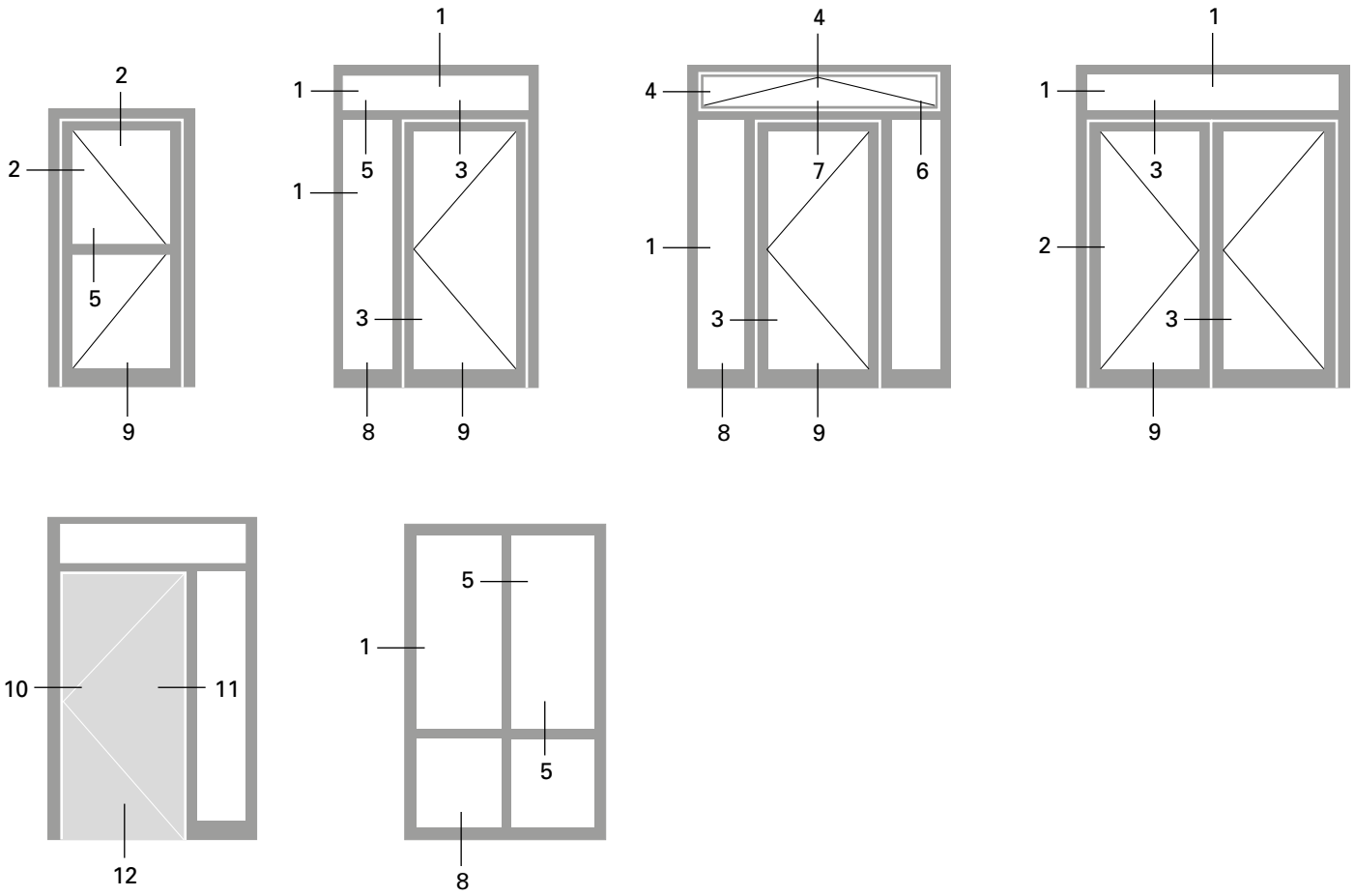

1.0

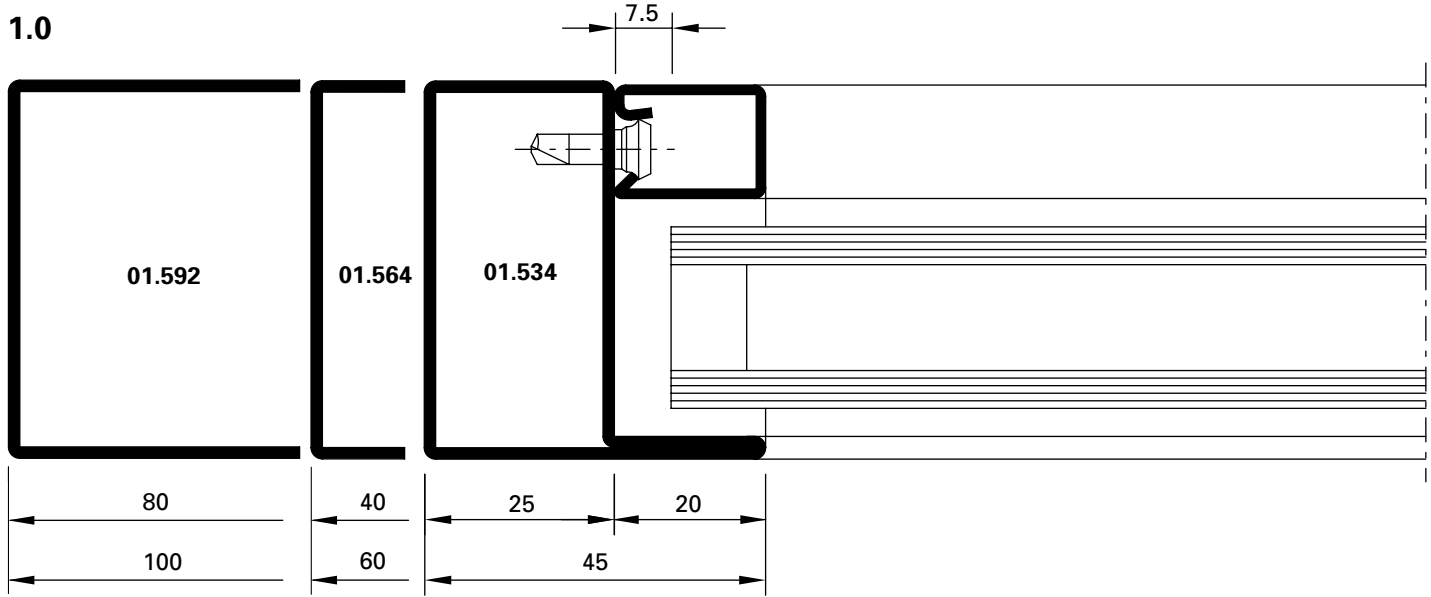

DXF DWG D-200-C-001

2.0

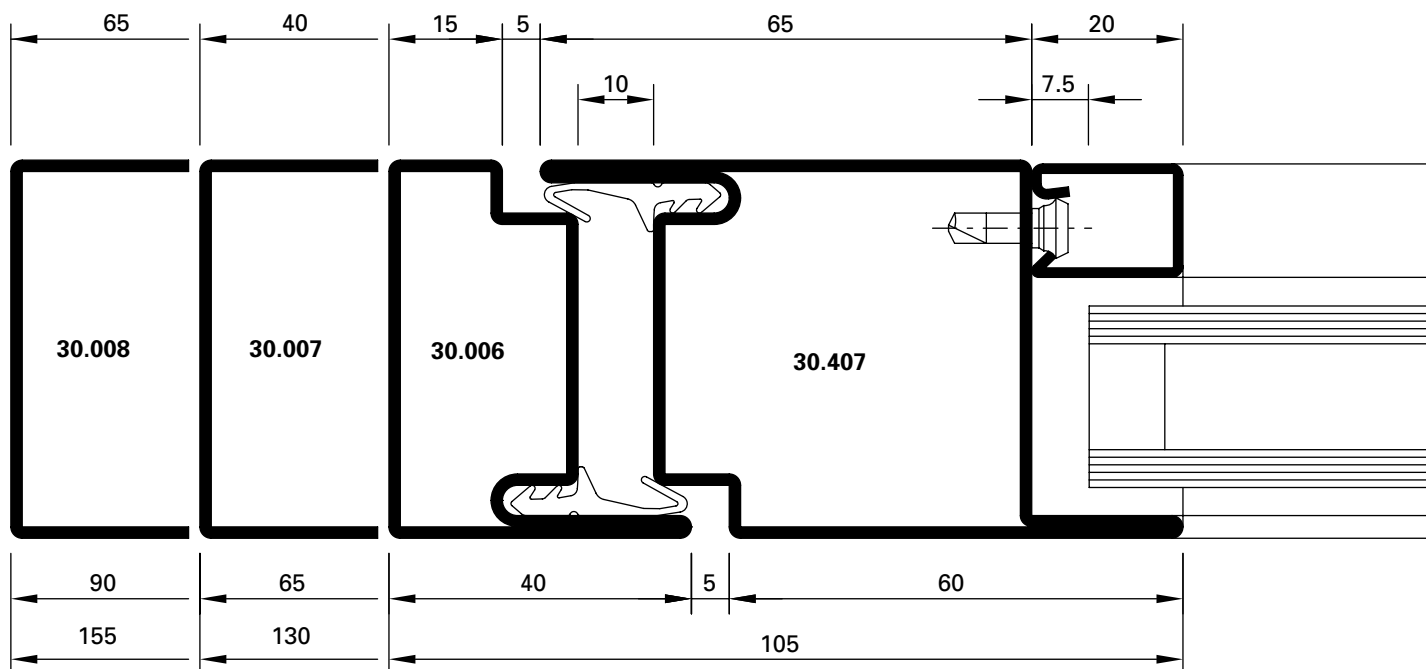

DXF **DWG** D-200-C-002

2.2

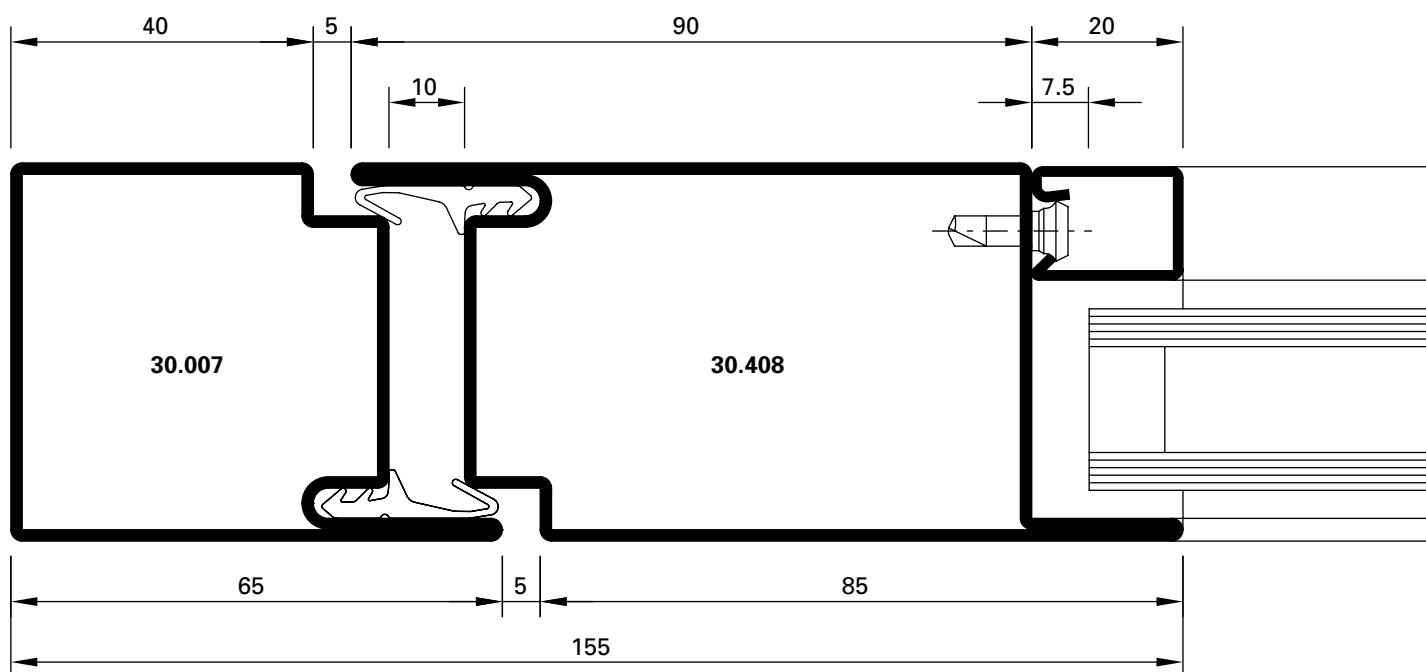

DXF **DWG** D-200-C-003

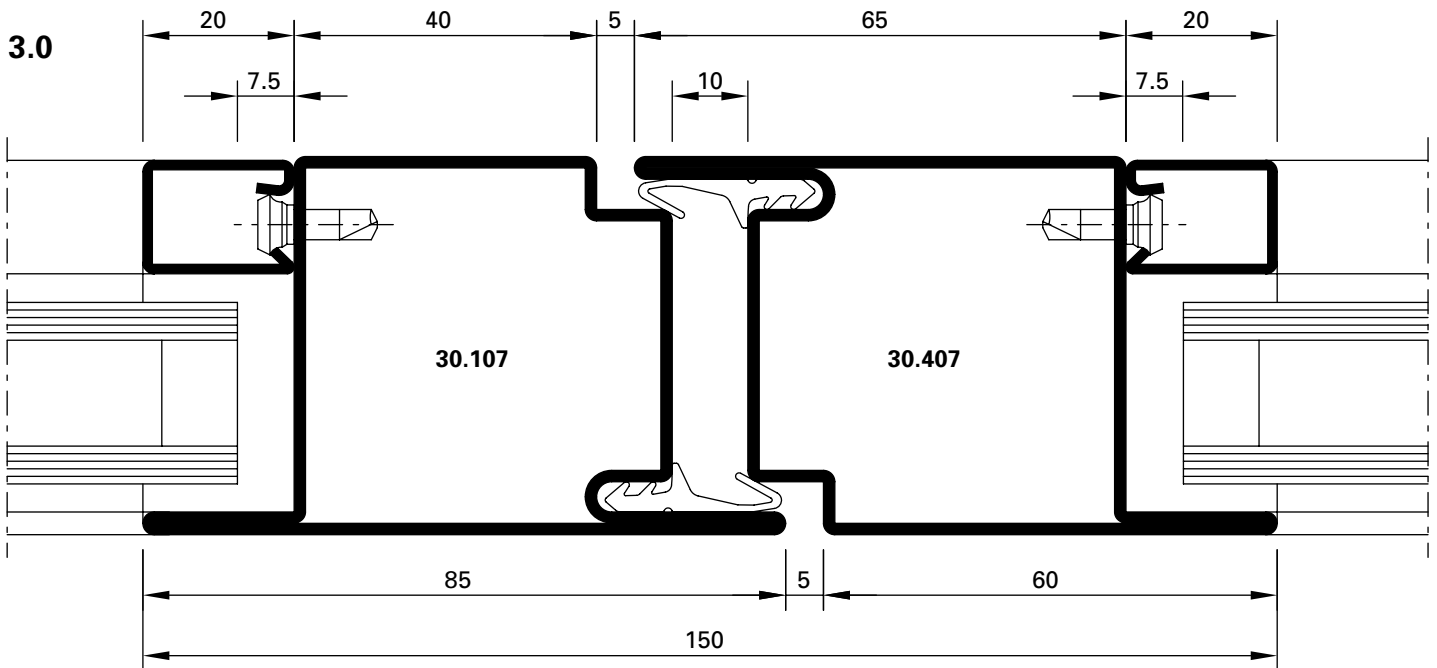

DXF **DWG** D-200-C-004

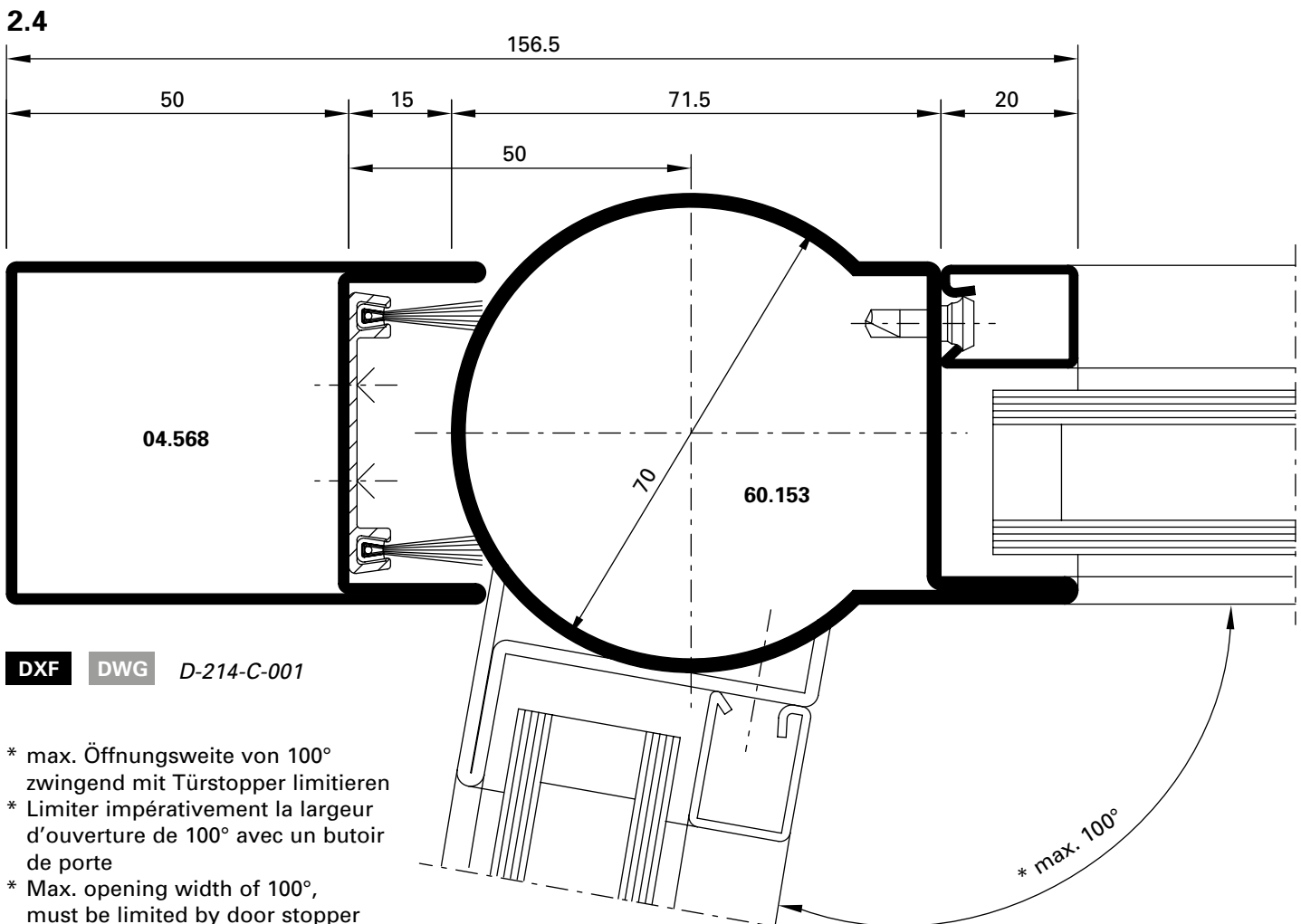

DXF **DWG** D-214-C-001

- * max. Öffnungsweite von 100° zwingend mit Türstopper limitieren
- * Limiter impérativement la largeur d'ouverture de 100° avec un butoir de porte
- * Max. opening width of 100°, must be limited by door stopper

10.0

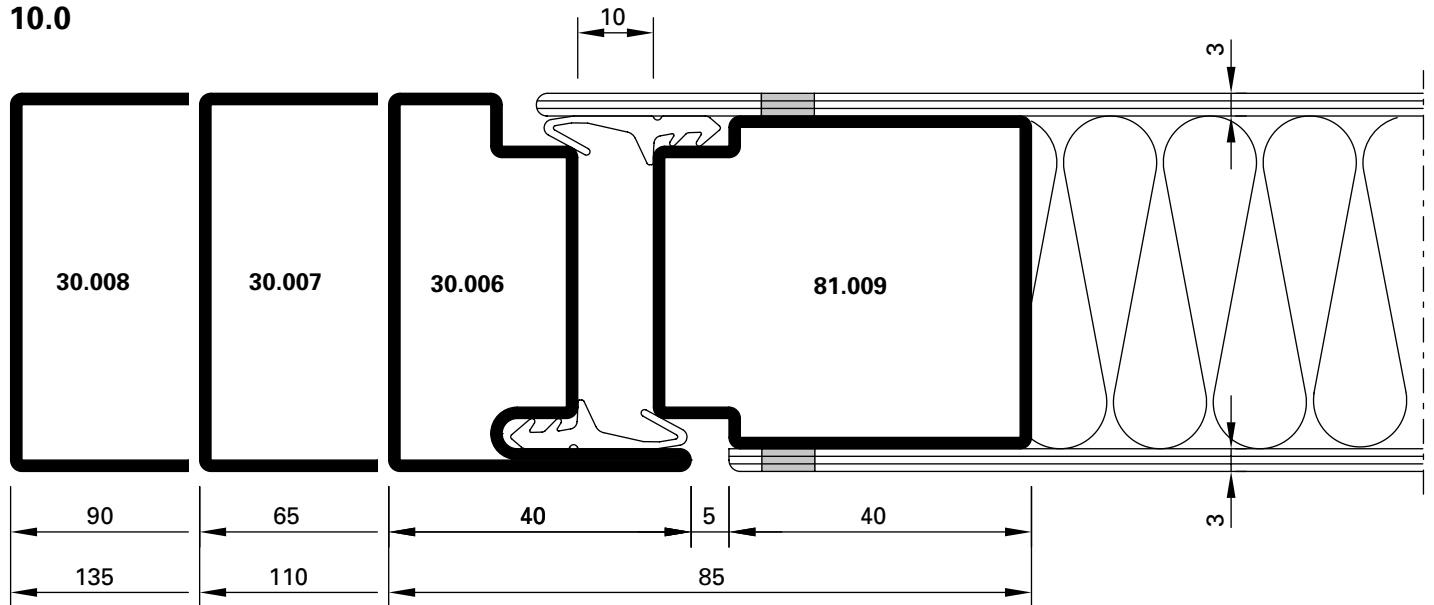

DXF **DWG** D-200-C-010

1.4

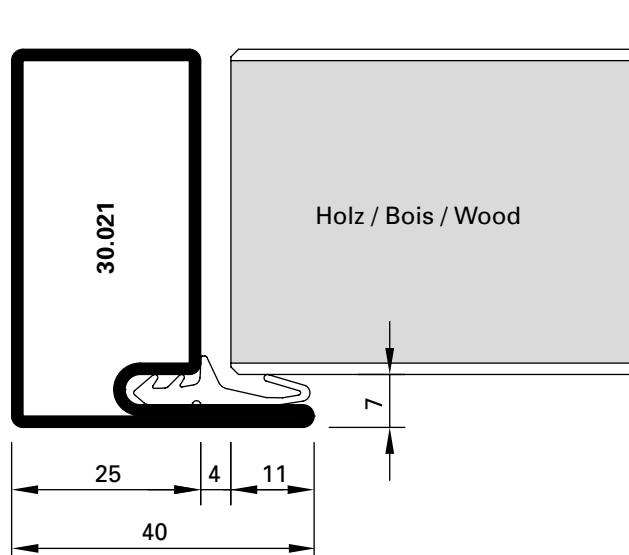

DXF **DWG** D-200-C-050

5.1

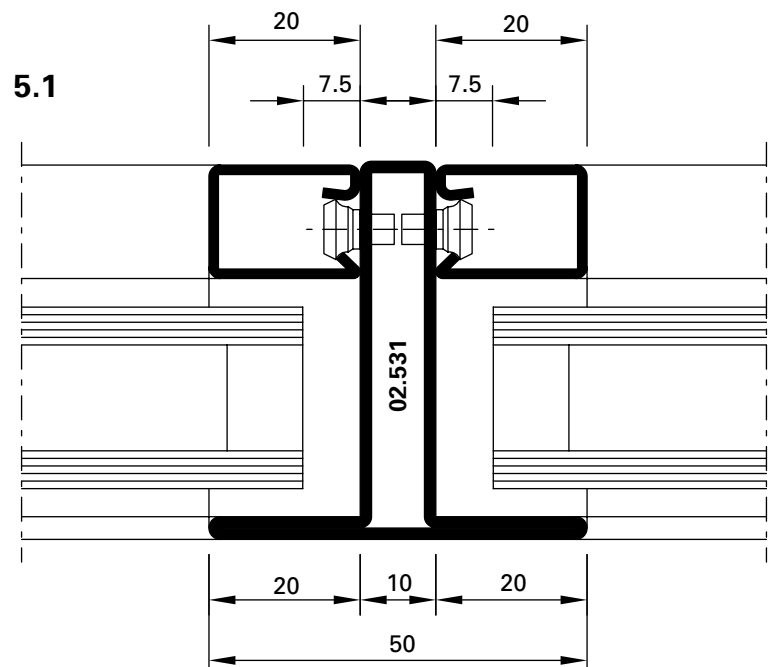

DXF **DWG** D-200-C-018

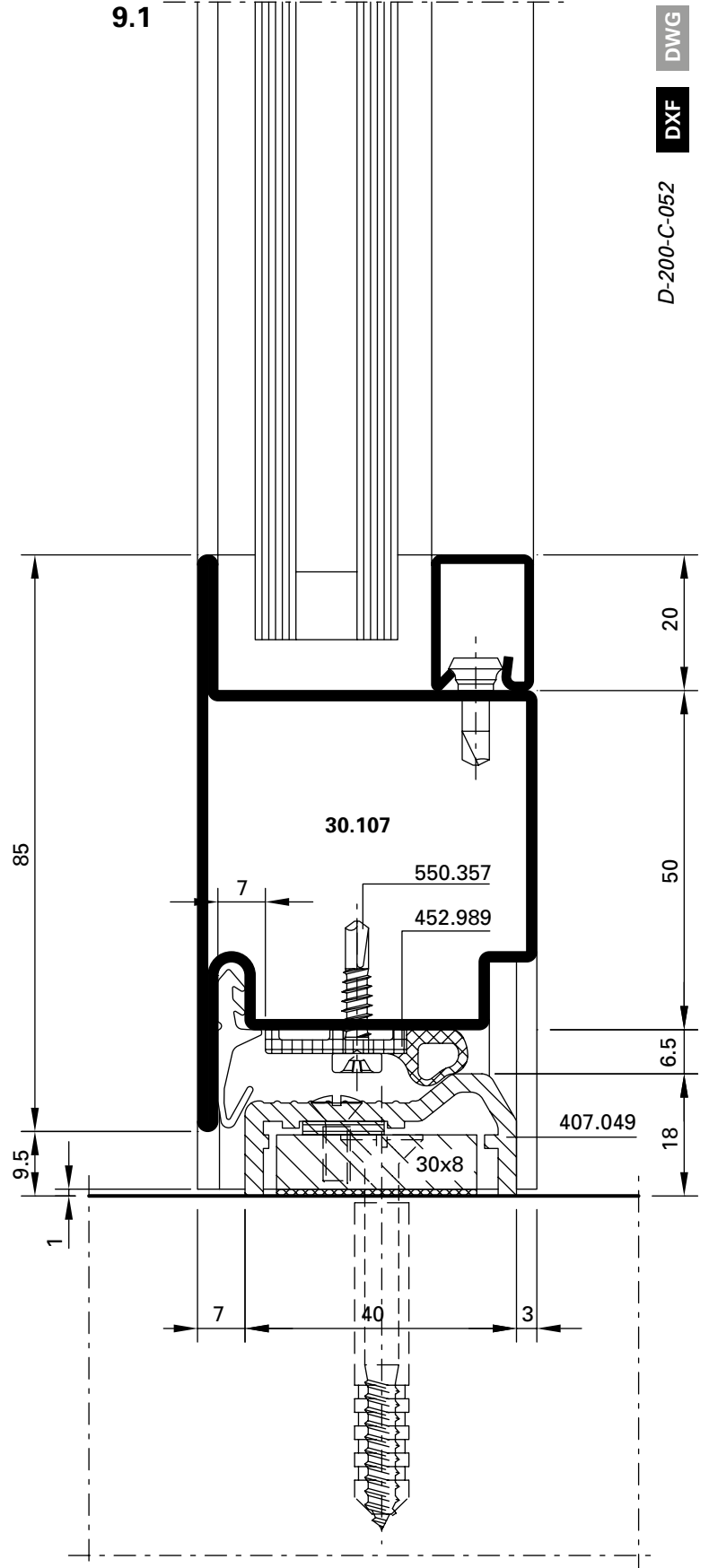
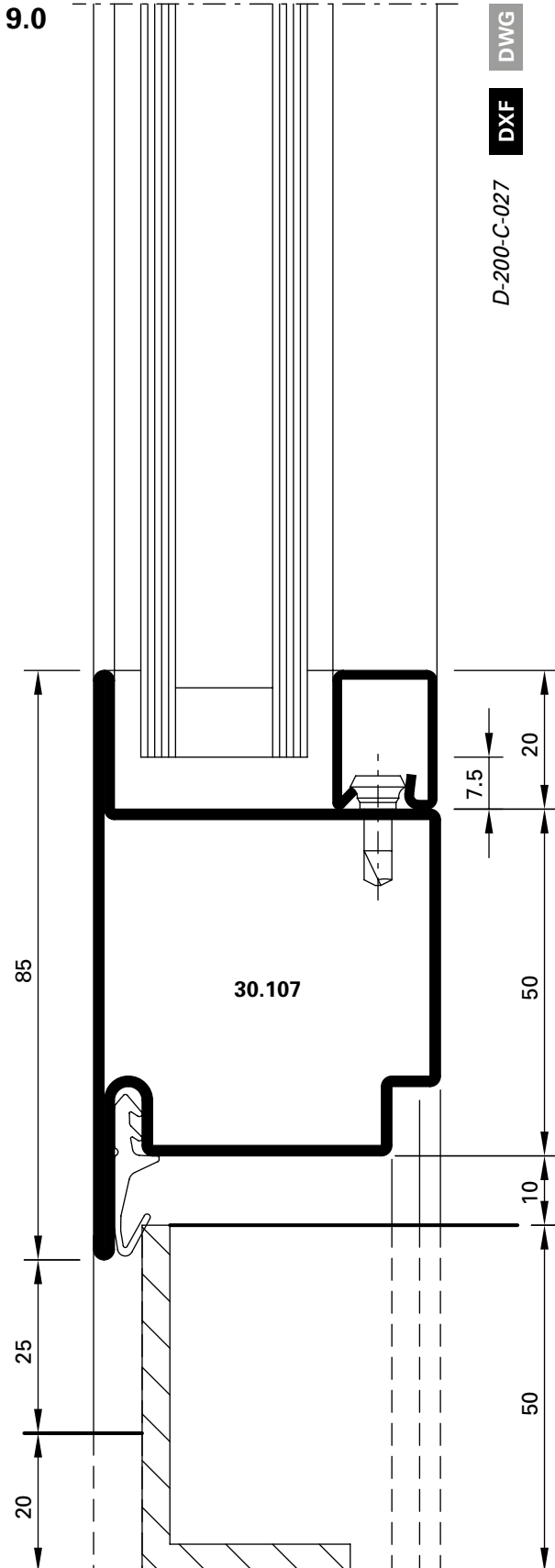

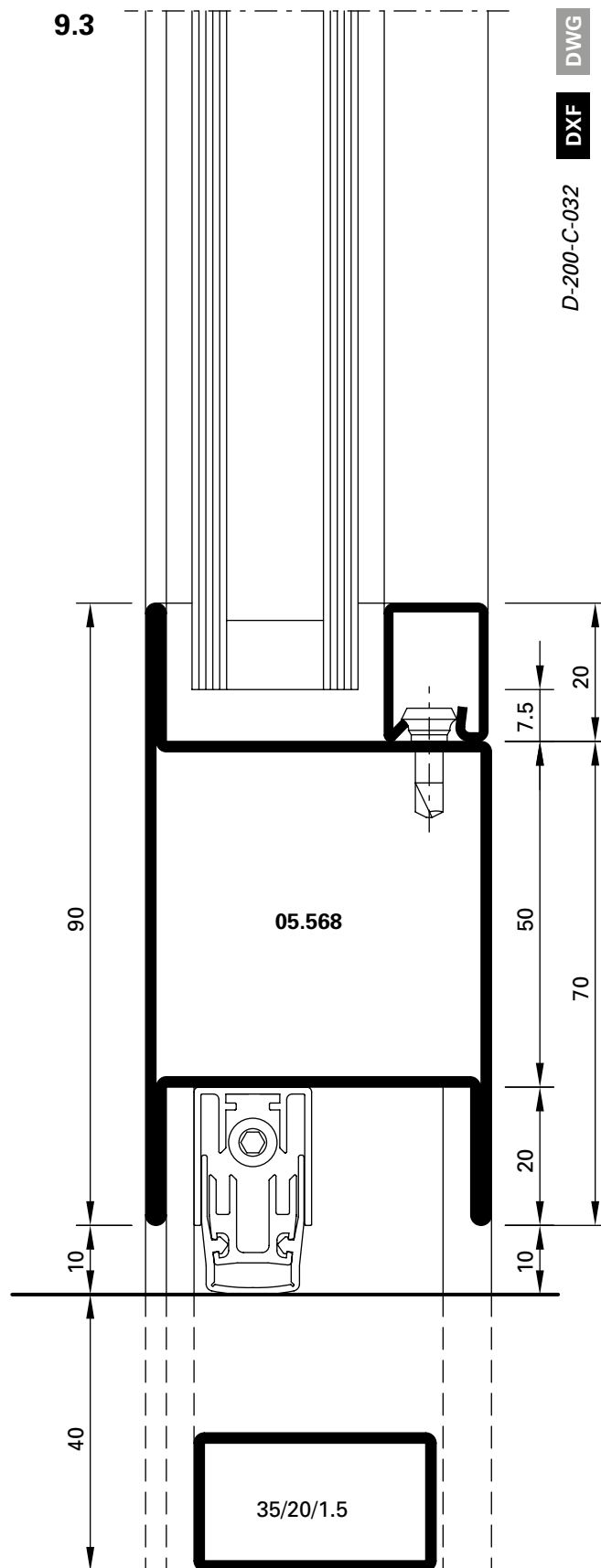
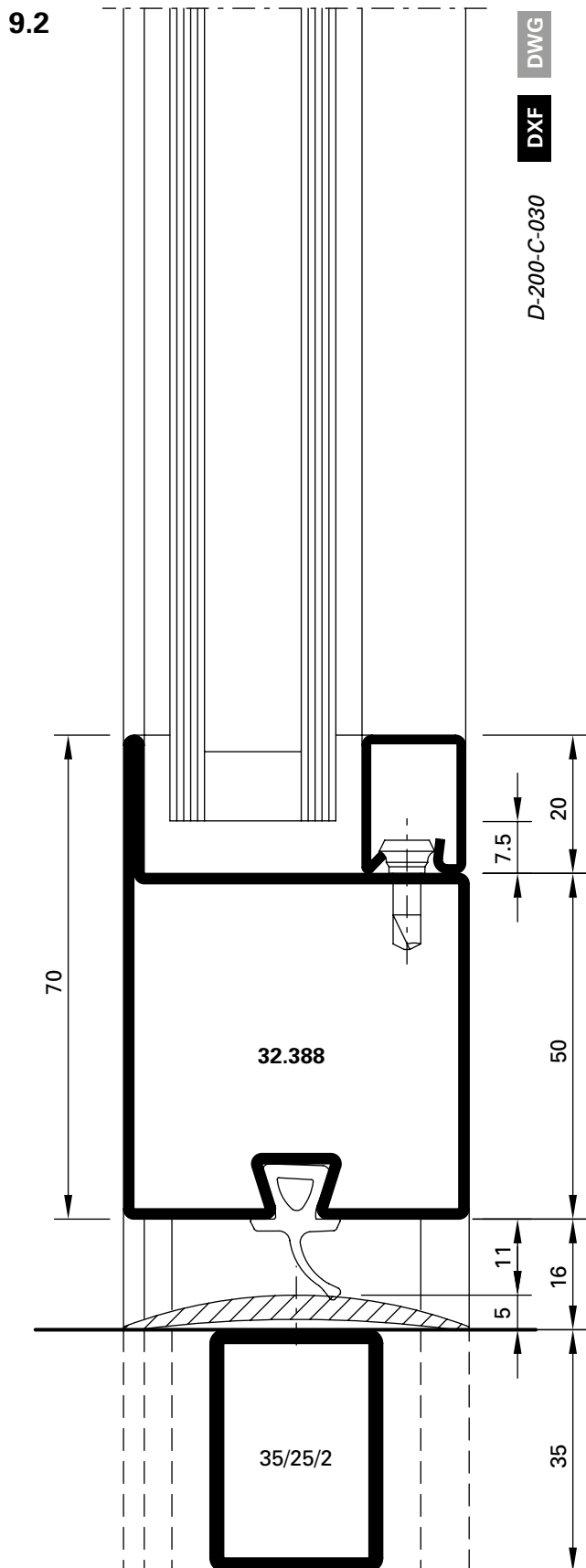

2.1

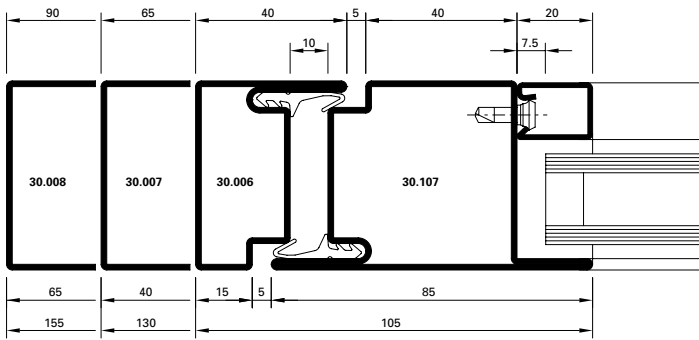

DXF **DWG** *D-200-C-006*

2.3

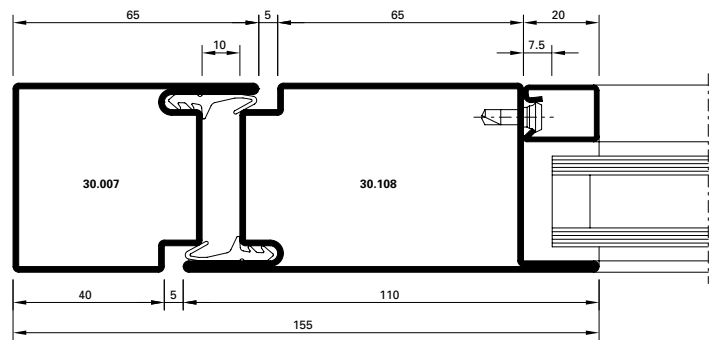

DXF **DWG** *D-200-C-007*

3.1

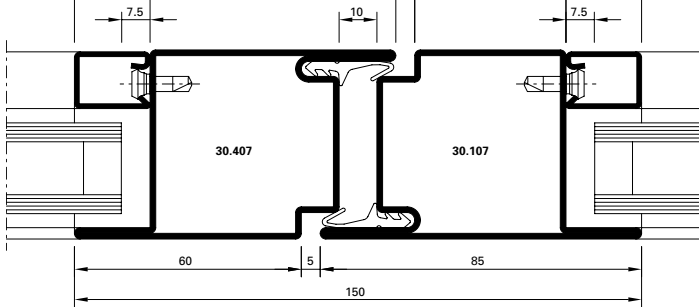

DXF **DWG** *D-200-C-008*

3.2

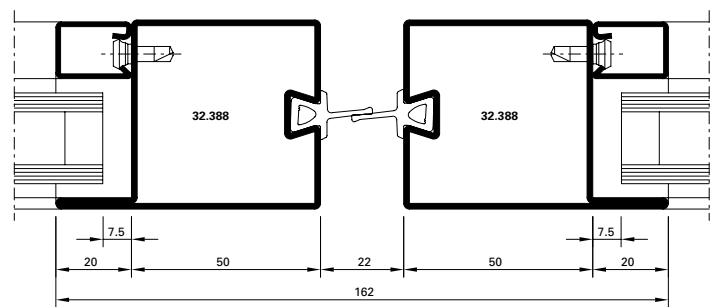

DXF **DWG** *D-200-C-009*

11.0

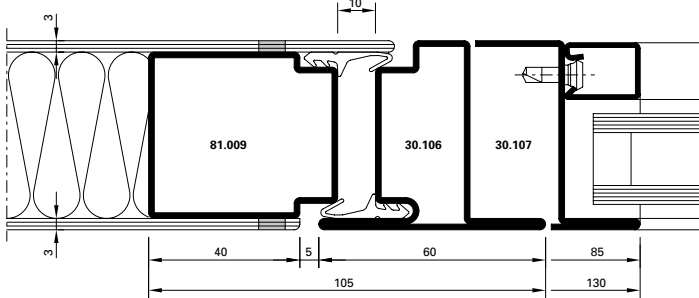

DXF **DWG** *D-200-C-012*

10.1

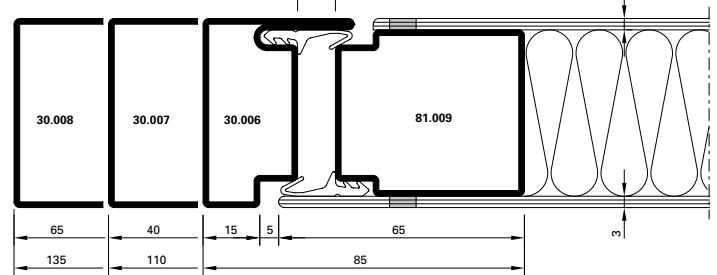

DXF **DWG** *D-200-C-011*

1.1

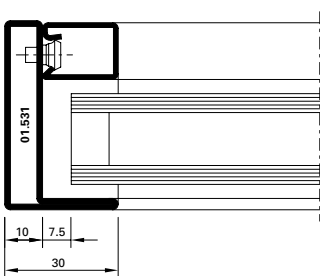

DXF **DWG** *D-200-C-013*

1.2

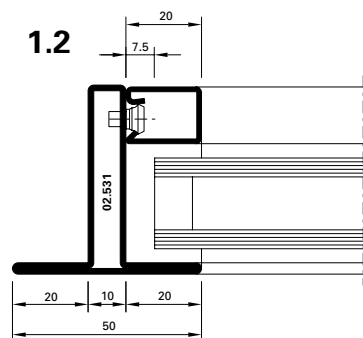

DXF **DWG** *D-200-C-051*

1.3



DXF **DWG** *D-200-C-014*

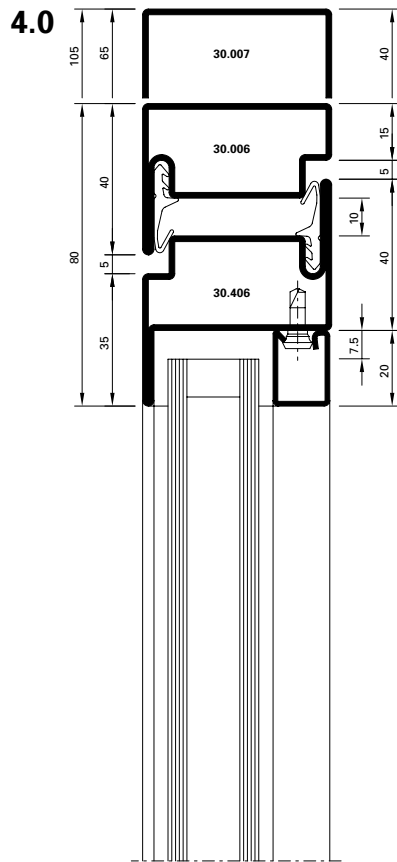

DWG

DXF

D-200-C-015

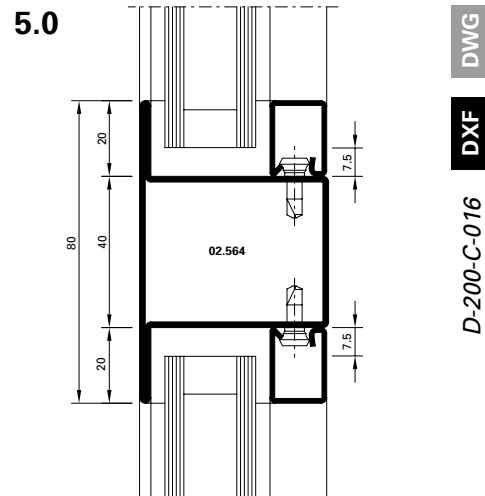

DWG

DXF

D-200-C-016

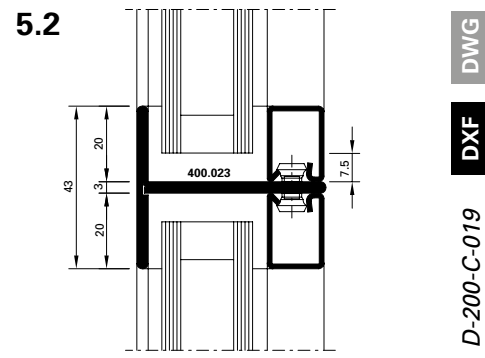

DWG

DXF

D-200-C-019

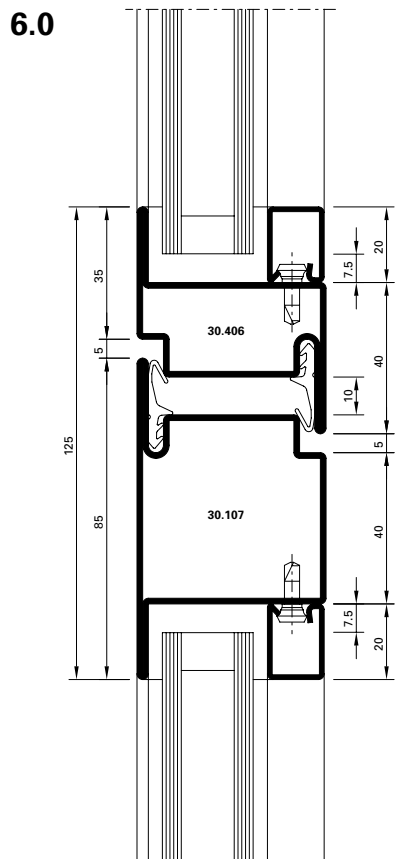

DWG

DXF

D-200-C-017

7.0

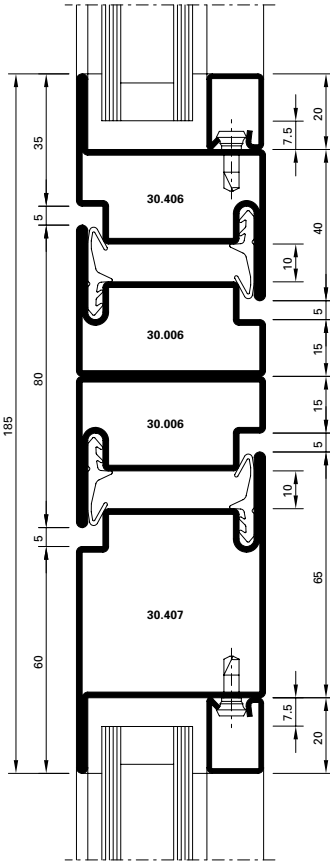

DWG

DXF

D-200-C-020

7.1

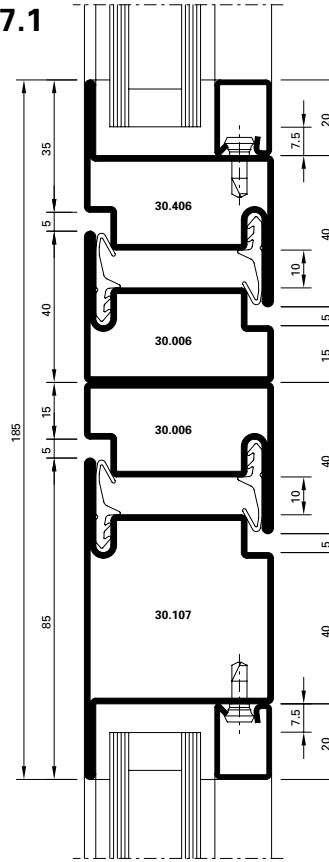

DWG

DXF

D-200-C-021

7.2

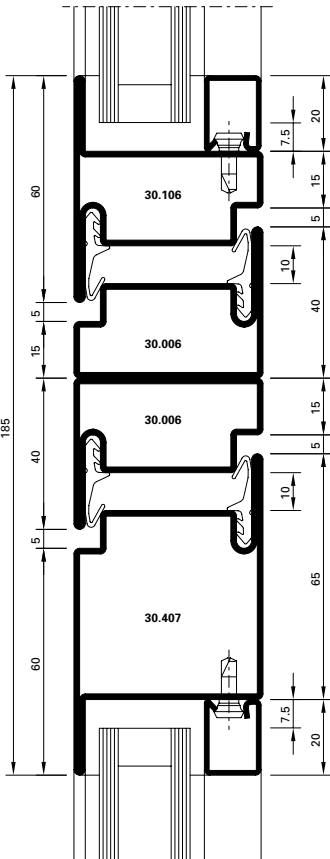

DWG

DXF

D-200-C-022

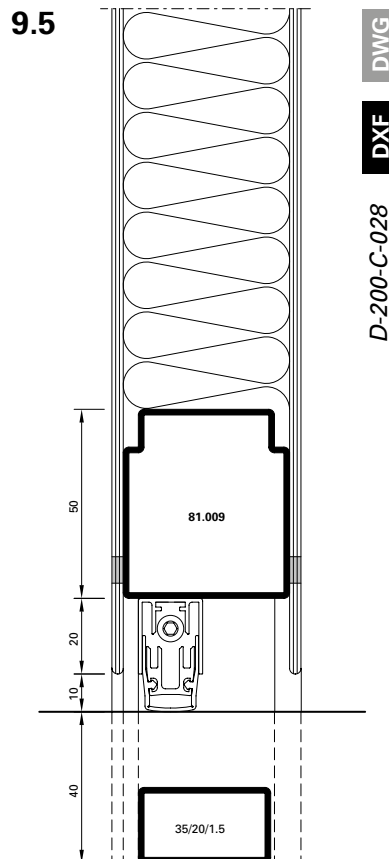
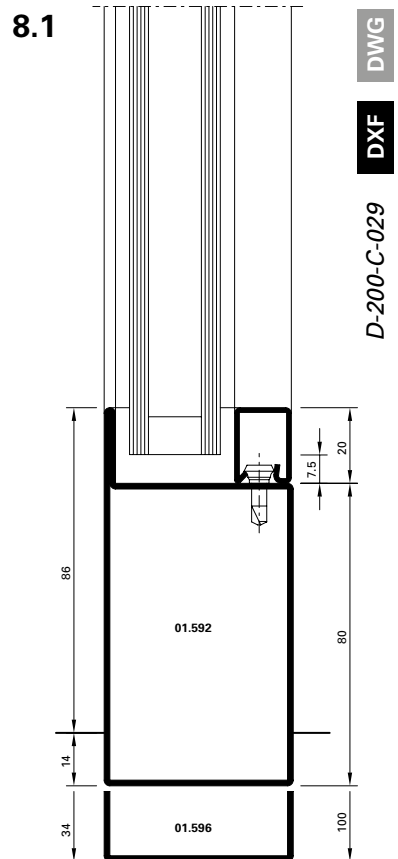
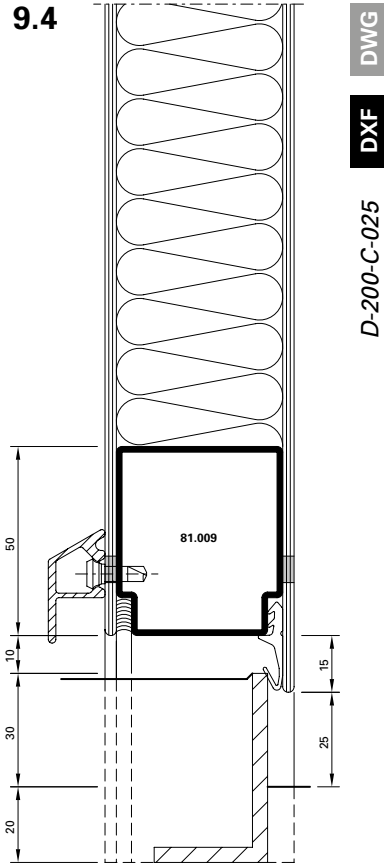
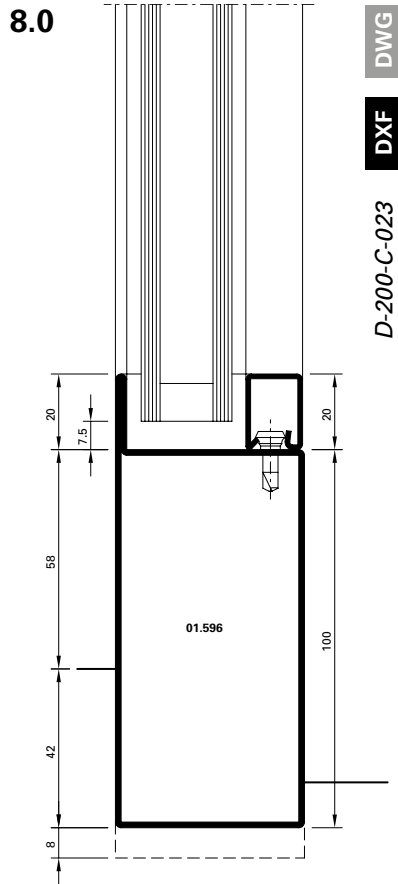

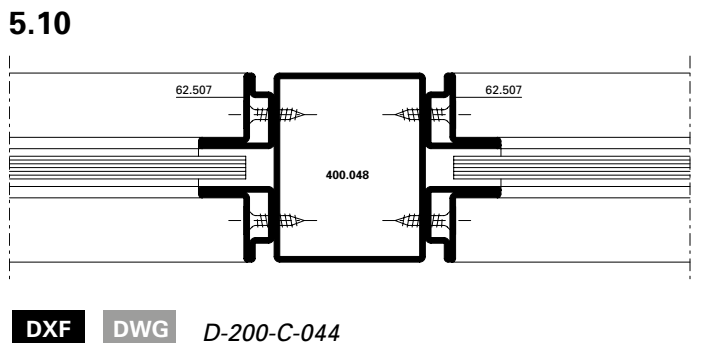
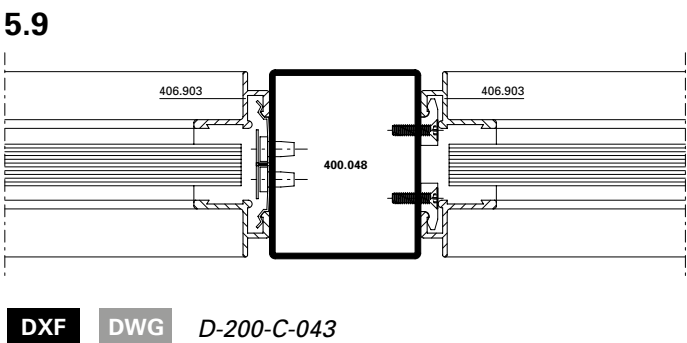
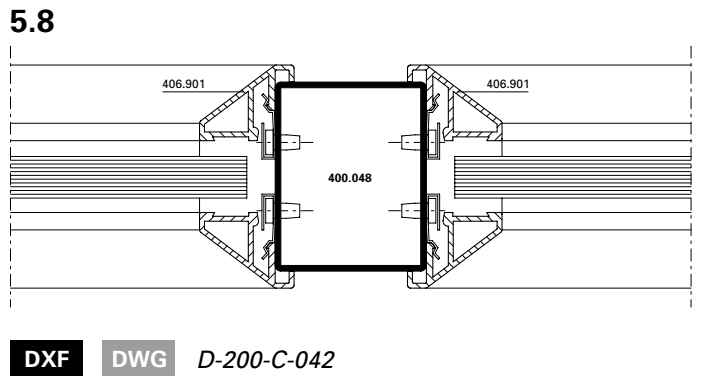
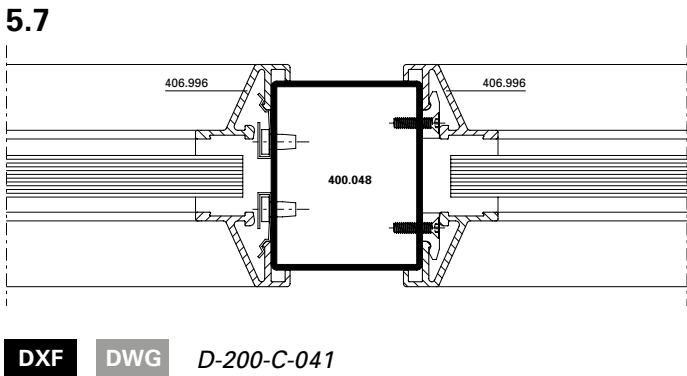
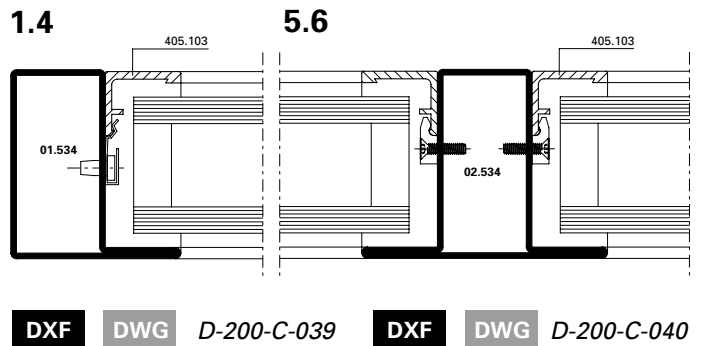
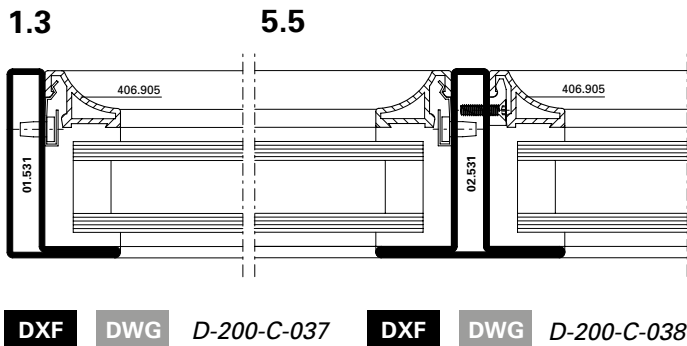
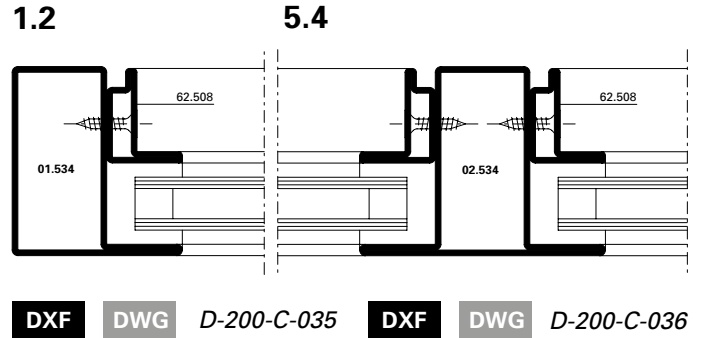
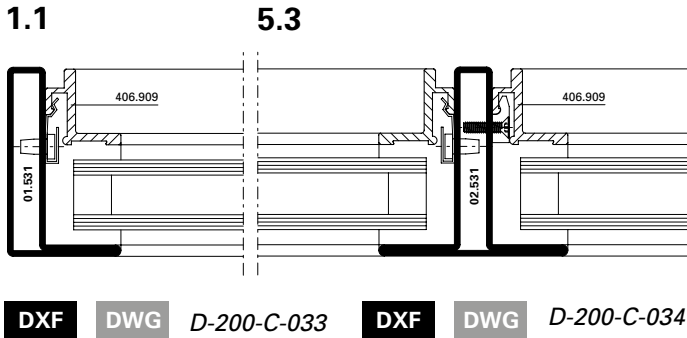

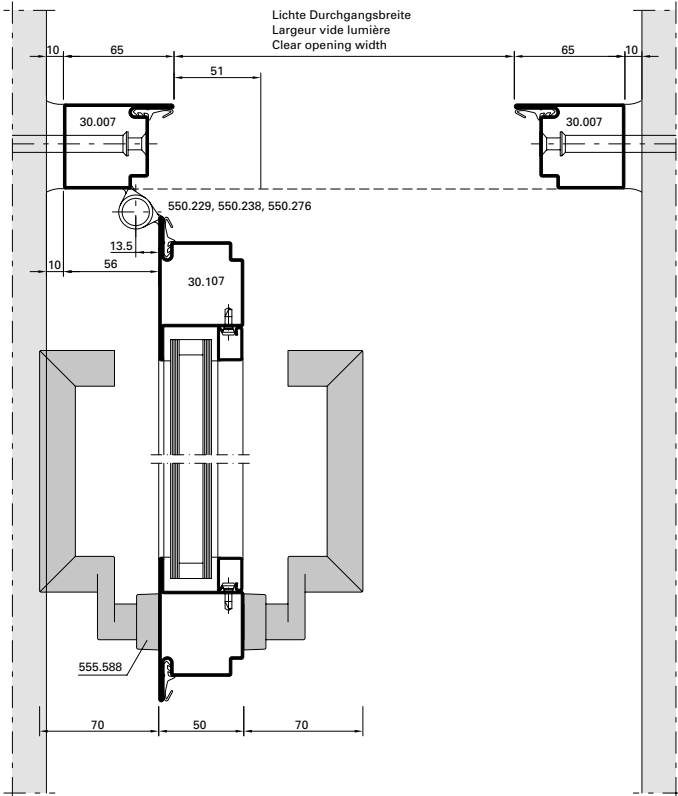

DXF **DWG** *D-200-E-001*

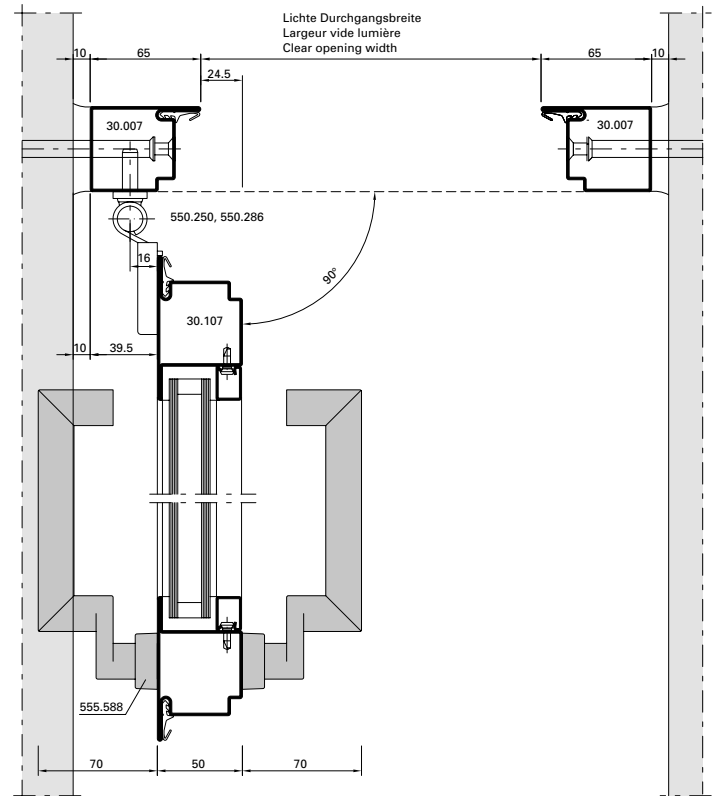

DXF **DWG** *D-200-E-003*

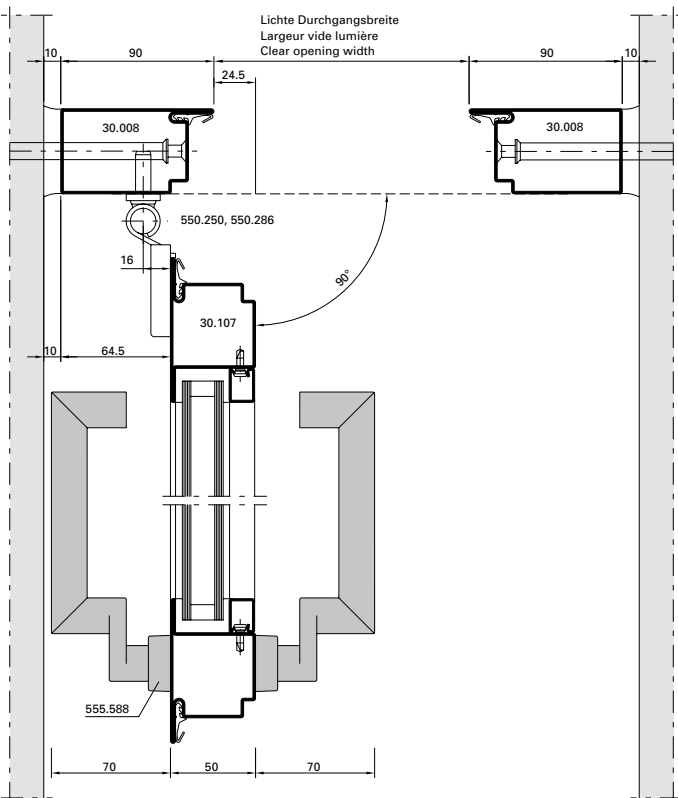

DXF **DWG** *D-200-E-004*

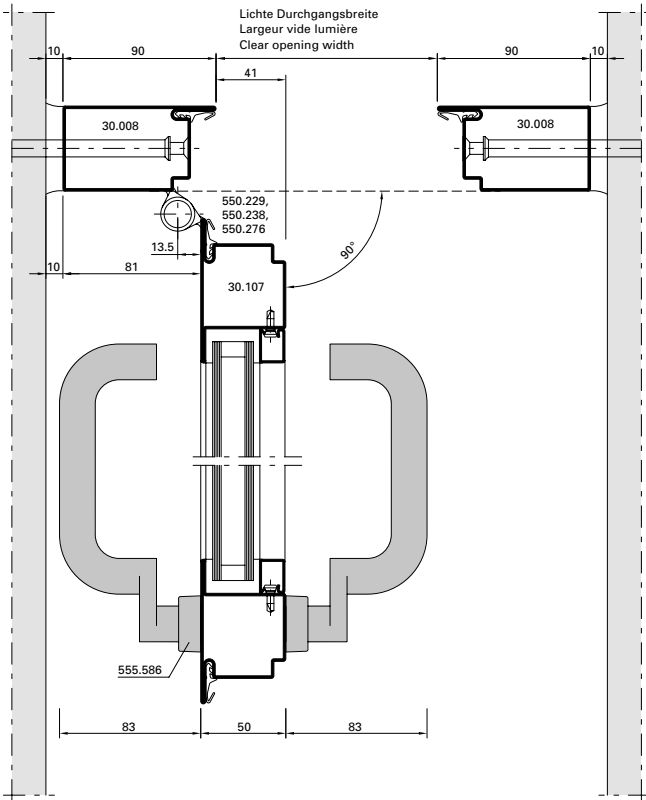

DXF **DWG** *D-200-E-002*

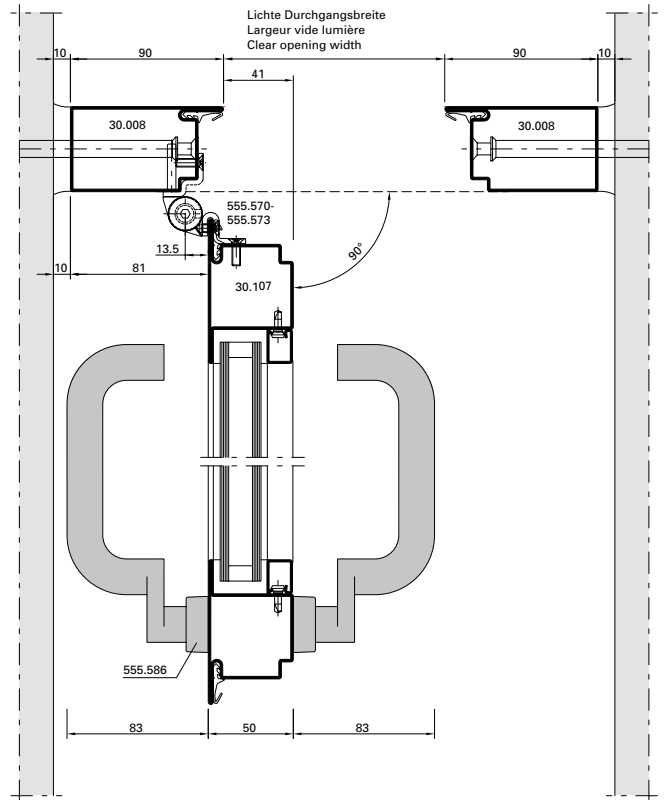

DXF **DWG** *D-200-E-018*

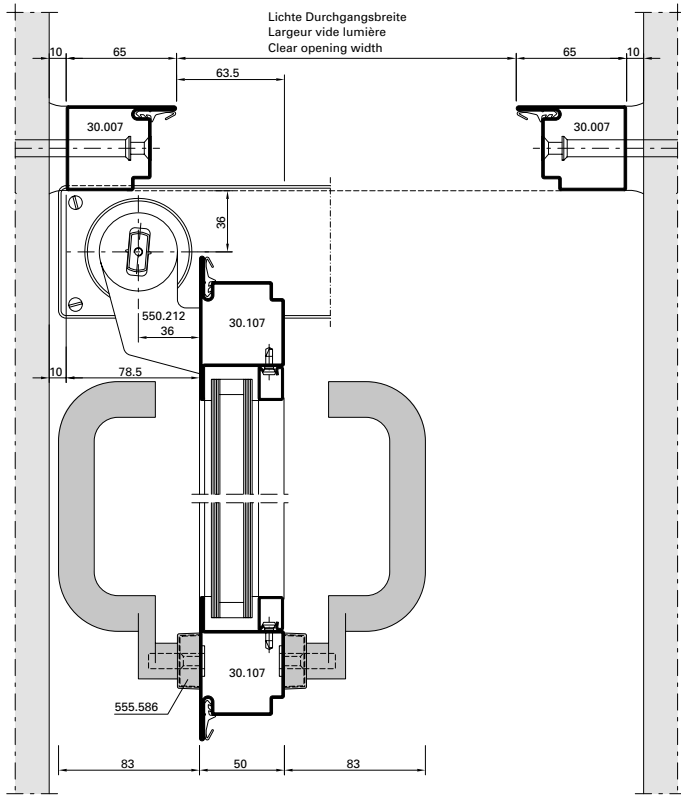

DXF **DWG** *D-200-E-005*

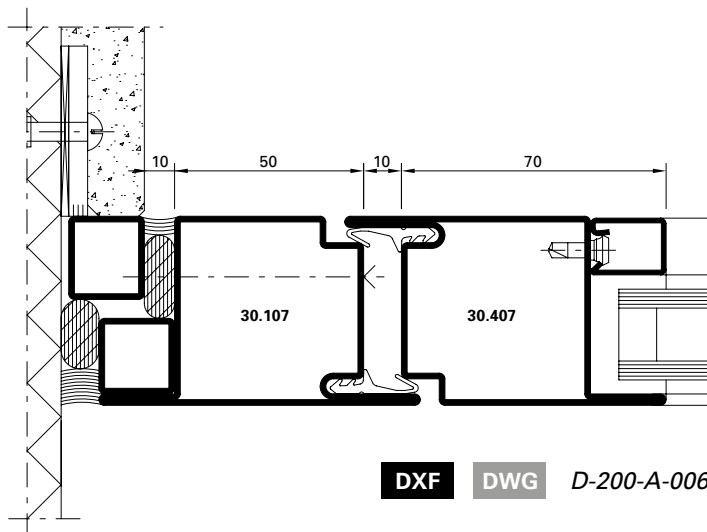
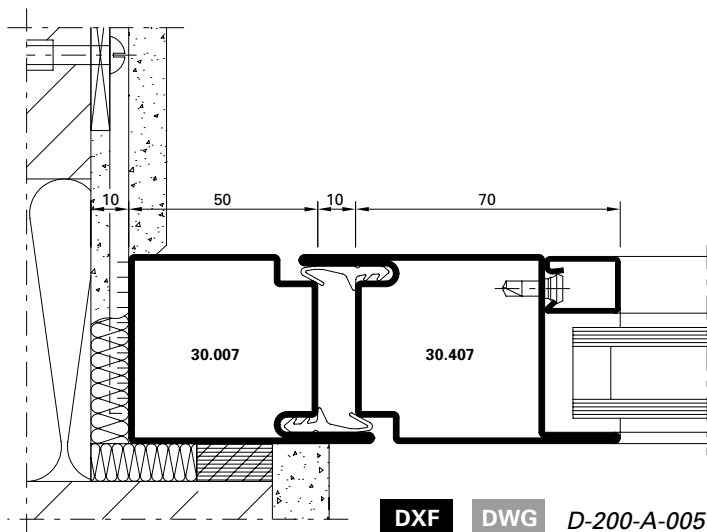
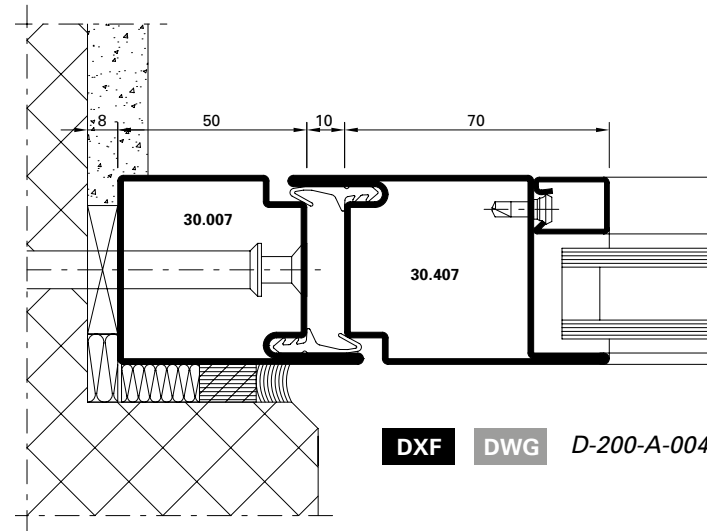
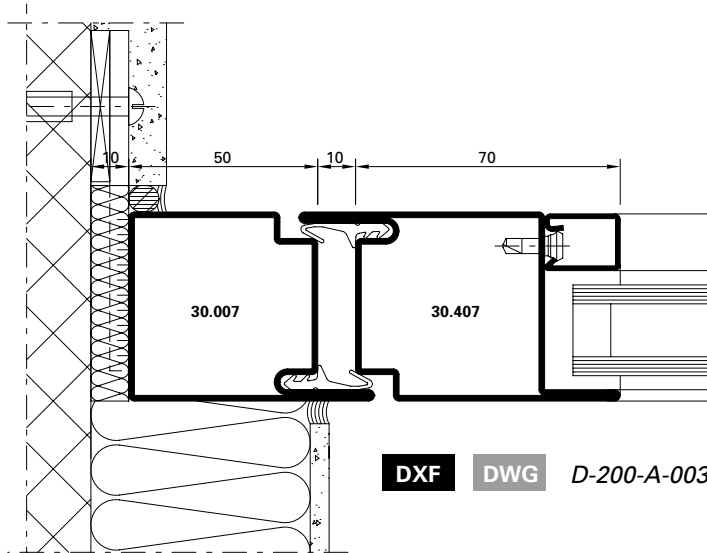
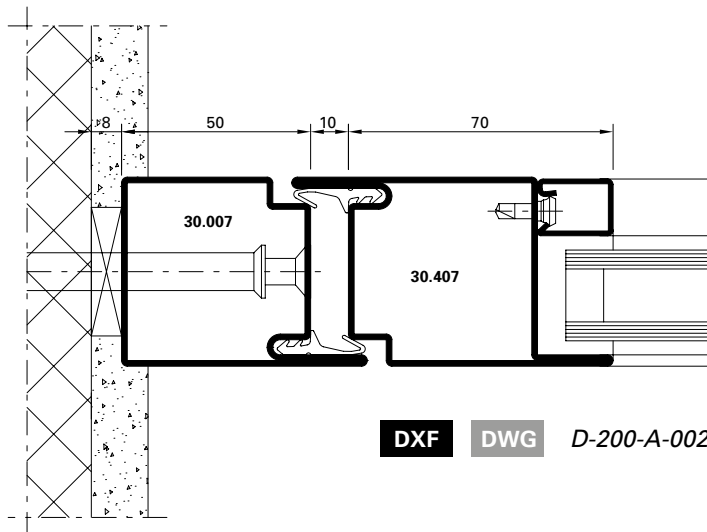
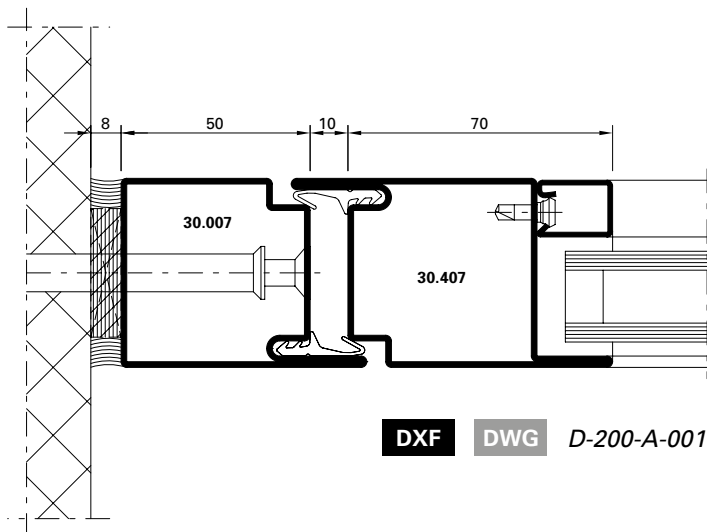

DXF DWG

D-200-A-007

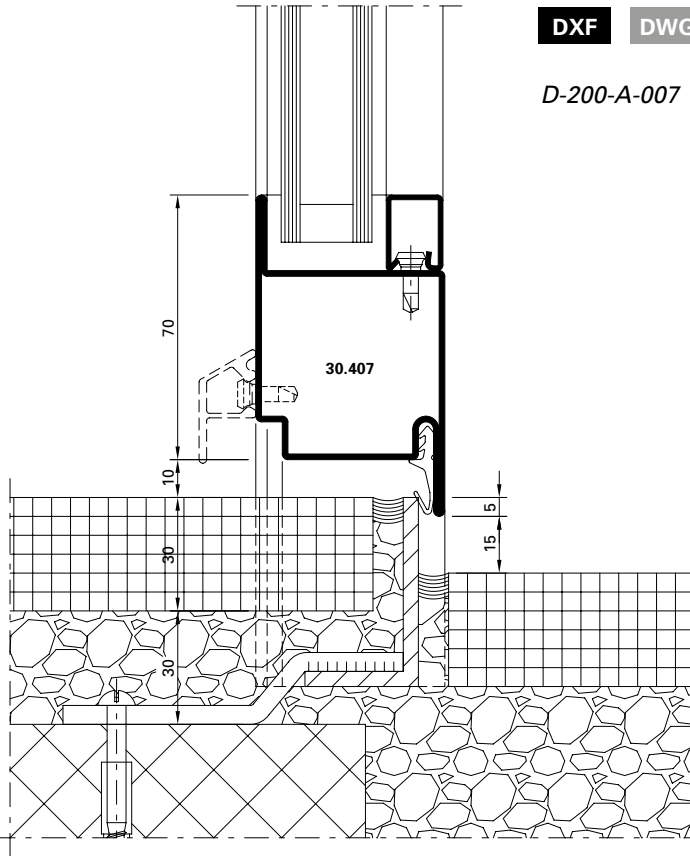

DXF DWG

D-200-A-008

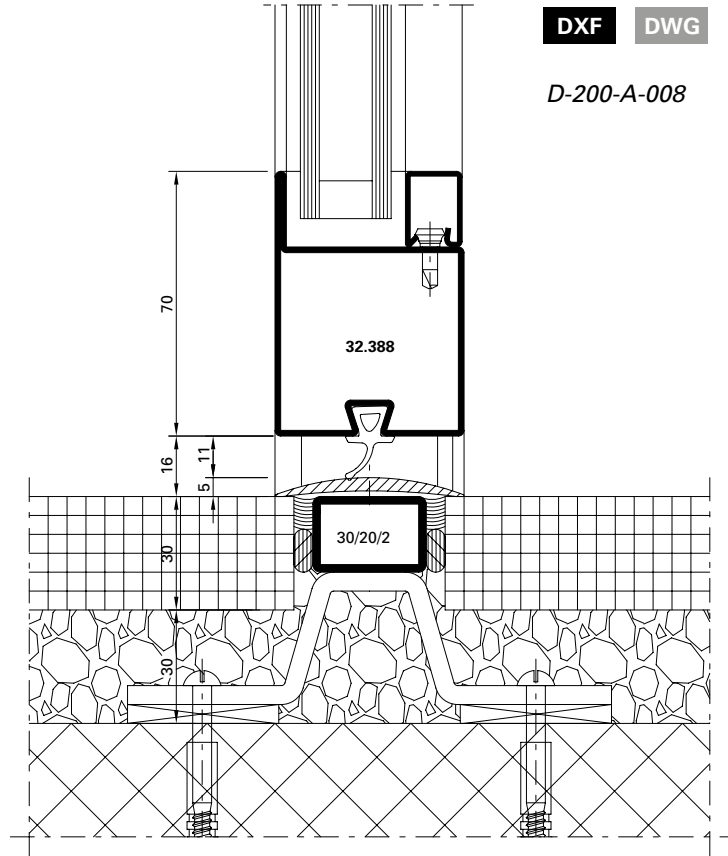

DXF DWG

D-200-A-009

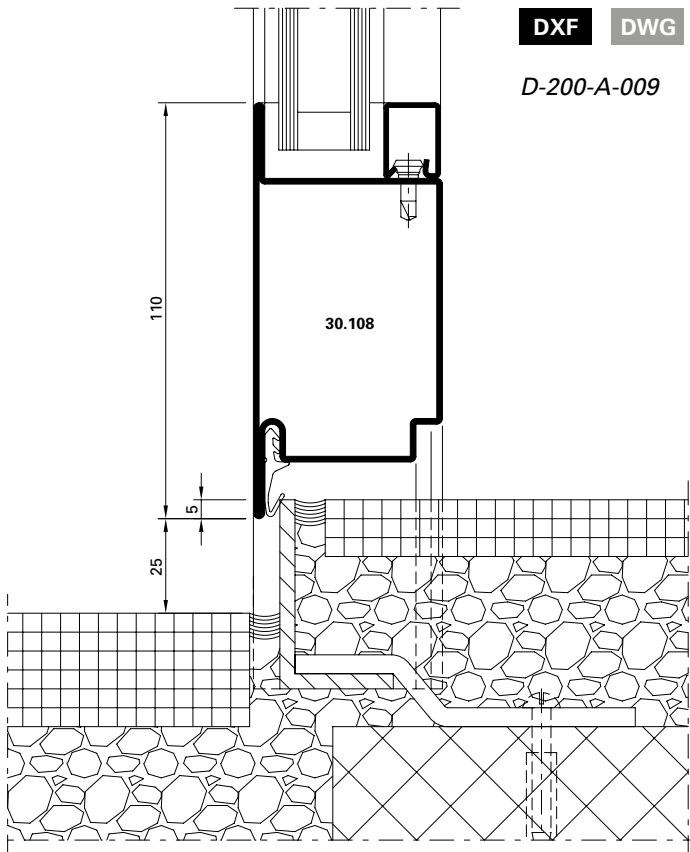

DXF DWG



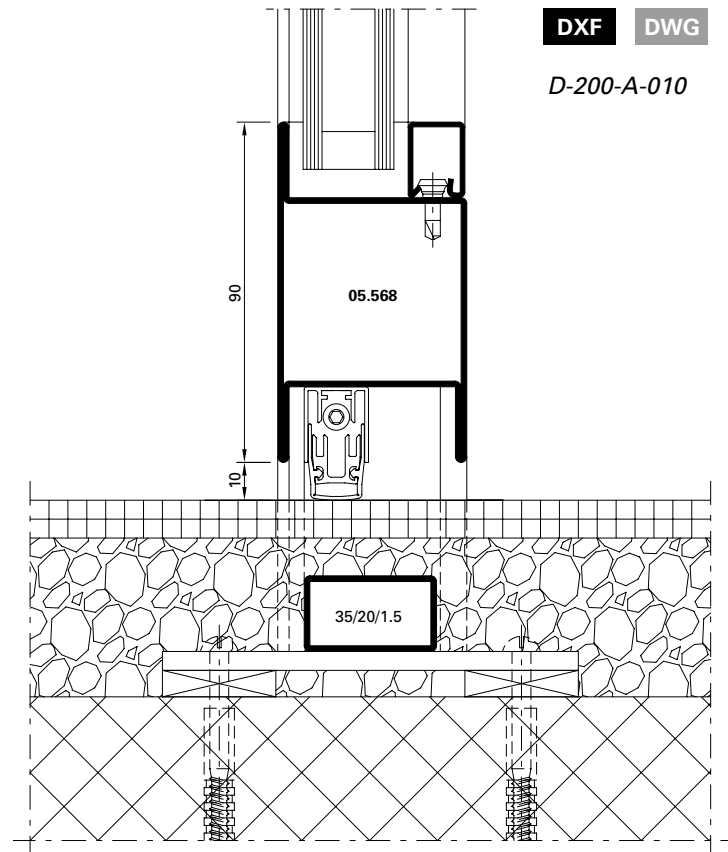

D-200-A-010



Einflügelige Türen,
 auswärts öffnend,
 Flügelhöhe ≤ 2200 mm

Porte à un vantail,
 ouvrant vers l'extérieur,
 hauteur du vantail ≤ 2200 mm

Single leaf door,
 outward opening,
 leaf height ≤ 2200 mm

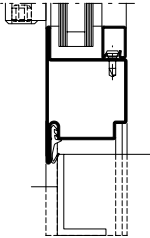
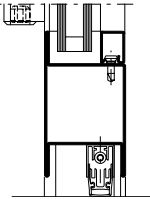
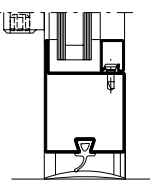
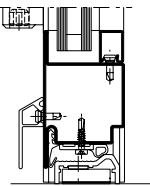
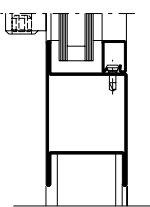
Variante		Beschlag Ferrure Fitting	 EN 12207	 EN 12208	 EN 12210
Anschlagdichtung Joint de butée Rebate gasket		❶	2	1A	C4 / C3*
		❷	3	2A	C5 / C4*
Senkdichtung Joint seuil Drop seal		❶	2	1A	C4 / C3*
		❷	3	2A	C5 / C4*
Auflaufdichtung Joint de contact Ramp seal		❶	2	0	npd
		❷	2	0	npd
Doppel-Anschlagdichtung Joint de butée double Double rebate gasket		❶	4	3A	C4 / C3*
		❷	4	4A	C5 / C4*
		❶	npd	npd	C1
		❷	npd	npd	C1

Die Werte gelten für Trocken- und Nassverglasung

Les valeurs sont valable pour vitrage à sec et vitrage à mastic

The values are valid for dry glazing and glazing with sealing

❶ Fallenriegel-Schloss
 Serrure à mortaiser
 Latch and bolt lock





❷ Schloss mit Obenverriegelung
 Serrure avec verrouillage supérieur
 Lock with top locking point

* Edelstahl
 * Acier Inox
 * Stainless steel

Einflügelige Türen,
 einwärts öffnend,
 Flügelhöhe ≤ 2200 mm

Porte à un vantail,
 ouvrant vers l'intérieur,
 hauteur du vantail ≤ 2200 mm

Single leaf door,
 inward opening,
 leaf height ≤ 2200 mm

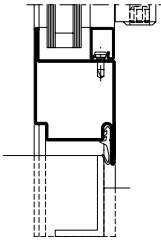
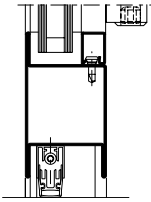
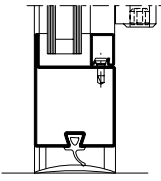
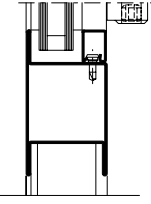
Variante		Beschlag Ferrure Fitting	 EN 12207	 EN 12208	 EN 12210
Anschlagdichtung Joint de butée Rebate gasket		1	2	0	C4 / C3*
		2	3	0	C4
Senkdichtung Joint seuil Drop seal		1	2	0	C4 / C3*
		2	3	1A	C4
Auflaufdichtung Joint de contact Ramp seal		1	2	0	C4 / C3*
		2	2	0	C4
		1	npd	npd	C1
		2	npd	npd	C1

Die Werte gelten für Trocken- und Nassverglasung





Les valeurs sont valable pour vitrage à sec et vitrage à mastic

The values are valid for dry glazing and glazing with sealing

Einflügelige Türen,
 auswärts öffnend,
 Flügelhöhe ≤ 2500 mm

Porte à un vantail,
 ouvrant vers l'extérieur,
 hauteur du vantail ≤ 2500 mm

Single leaf door,
 outward opening,
 leaf height ≤ 2500 mm

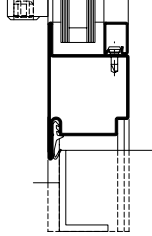
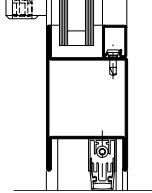
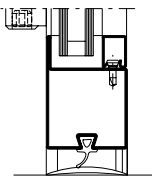
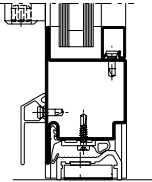
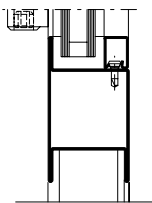
Variante		Beschlag Ferrure Fitting	 EN 12207	 EN 12208	 EN 12210
Anschlagdichtung Joint de butée Rebate gasket		1	2	0	C2
		2	2	1A	C3
Senkdichtung Joint seuil Drop seal		1	2	0	C2
		2	2	1A	C3
Auflaufdichtung Joint de contact Ramp seal		1	1	0	C2
		2	2	0	C3
Doppel-Anschlagdichtung Joint de butée double Double rebate gasket		1	2	2A	C2
		2	3	3A	C3
		1	npd	npd	C1
		2	npd	npd	C1

Die Werte gelten für Trocken- und Nassverglasung





Les valeurs sont valable pour vitrage à sec et vitrage à mastic

The values are valid for dry glazing and glazing with sealing

Einflügelige Türen,
 einwärts öffnend,
 Flügelhöhe ≤ 2500 mm

Porte à un vantail,
 ouvrant vers l'intérieur,
 hauteur du vantail ≤ 2500 mm

Single leaf door,
 inward opening,
 leaf height ≤ 2500 mm

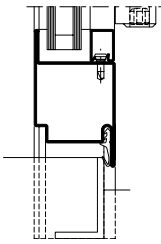
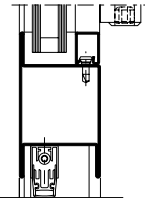
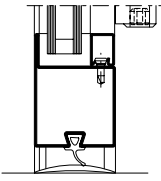
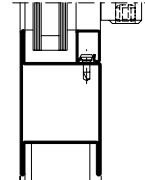
Variante		Beschlag Ferrure Fitting	 EN 12207	 EN 12208	 EN 12210
Anschlagdichtung Joint de butée Rebate gasket		1	2	0	C2
		2	2	0	C3
Senkdichtung Joint seuil Drop seal		1	2	0	C2
		2	2	0	C3
Auflaufdichtung Joint de contact Ramp seal		1	1	0	C2
		2	2	0	C3
		1	npd	npd	C1
		2	npd	npd	C1

Die Werte gelten für Trocken- und Nassverglasung

Les valeurs sont valables pour vitrage à sec et vitrage à mastic

The values are valid for dry glazing and glazing with sealing





1 Fallenriegel-Schloss
 Serrure à mortaiser
 Latch and bolt lock

2 Mehrfachverriegelung-Schloss
 Serrure à verrouillage multiple
 Multipoint lock

Zweiflügelige Türen,
 auswärts öffnend,
 Flügelhöhe ≤ 2200 mm

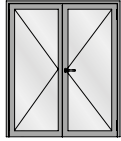
Porte à deux vantaux,
 ouvrant vers l'extérieur,
 hauteur du vantail ≤ 2200 mm

Double leaf door,
 outward opening,
 leaf height ≤ 2200 mm

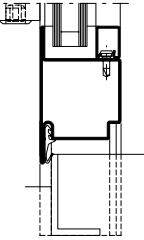
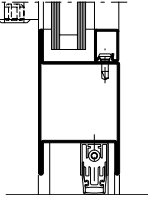
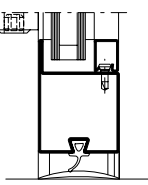
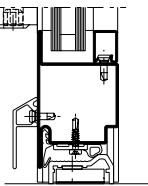
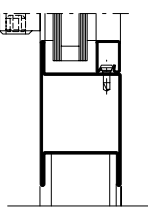
Variante		Beschlag Ferrure Fitting	 EN 12207	 EN 12208	 EN 12210
Anschlagdichtung Joint de butée Rebate gasket		❶	2	1A	C2
		❷	2	2A	C3
Senkdichtung Joint seuil Drop seal		❶	2	1A	C2
		❷	2	2A	C3
Auflaufdichtung Joint de contact Ramp seal		❶	2	0	C2
		❷	2	0	C3
Doppel-Anschlagdichtung Joint de butée double Double rebate gasket		❶	2	2A	C2
		❷	3	3A	C3
		❶	npd	npd	C1
		❷	npd	npd	C1

Die Werte gelten für Trocken- und Nassverglasung

Les valeurs sont valable pour vitrage à sec et vitrage à mastic

The values are valid for dry glazing and glazing with sealing





❶ Fallenriegel-Schloss
 Serrure à mortaiser
 Latch and bolt lock

❷ Mehrfachverriegelung-Schloss
 Serrure à verrouillage multiple
 Multipoint lock

Zweiflügelige Türen,
 einwärts öffnend,
 Flügelhöhe ≤ 2200 mm

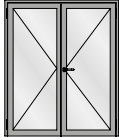
Porte à deux vantaux,
 ouvrant vers l'intérieur,
 hauteur du vantail ≤ 2200 mm

Double leaf door,
 inward opening,
 leaf height ≤ 2200 mm

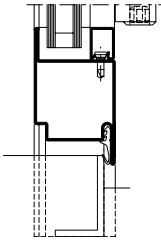
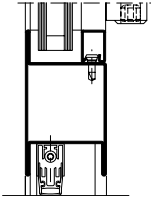
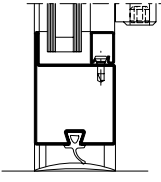
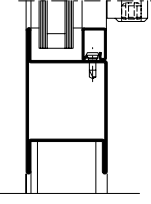
Variante		Beschlag Ferrure Fitting	 EN 12207	 EN 12208	 EN 12210
Anschlagdichtung Joint de butée Rebate gasket		1	2	0	C2
		2	2	0	C3
Senkdichtung Joint seuil Drop seal		1	2	0	C2
		2	2	0	C3
Auflaufdichtung Joint de contact Ramp seal		1	2	0	C2
		2	2	0	C3
		1	npd	npd	C1
		2	npd	npd	C1

Die Werte gelten für Trocken- und Nassverglasung

Les valeurs sont valables pour vitrage à sec et vitrage à mastic

The values are valid for dry glazing and glazing with sealing





1 Fallenriegel-Schloss
 Serrure à mortaiser
 Latch and bolt lock

2 Mehrfachverriegelung-Schloss
 Serrure à verrouillage multiple
 Multipoint lock

Zweiflügelige Türen,
 auswärts öffnend,
 Flügelhöhe ≤ 2500 mm

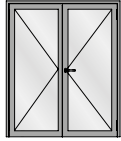
Porte à deux vantaux,
 ouvrant vers l'extérieur,
 hauteur du vantail ≤ 2500 mm

Double leaf door,
 outward opening,
 leaf height ≤ 2500 mm

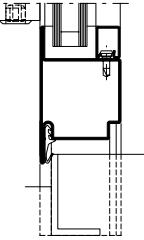
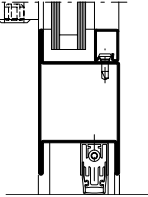
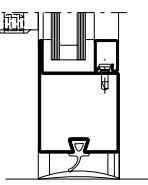
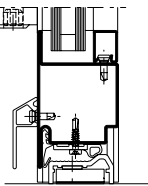
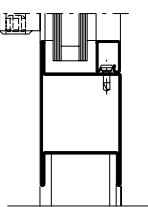
Variante		Beschlag Ferrure Fitting	 EN 12207	 EN 12208	 EN 12210
Anschlagdichtung Joint de butée Rebate gasket		❶	1	0	C2
		❷	2	1A	C3
Senkdichtung Joint seuil Drop seal		❶	1	0	C2
		❷	2	1A	C3
Auflaufdichtung Joint de contact Ramp seal		❶	1	0	C2
		❷	1	0	C3
Doppel-Anschlagdichtung Joint de butée double Double rebate gasket		❶	1	1A	C2
		❷	3	2A	C3
		❶	npd	npd	C1
		❷	npd	npd	C1

Die Werte gelten für Trocken- und Nassverglasung

Les valeurs sont valable pour vitrage à sec et vitrage à mastic

The values are valid for dry glazing and glazing with sealing





❶ Fallenriegel-Schloss
 Serrure à mortaiser
 Latch and bolt lock

❷ Mehrfachverriegelung-Schloss
 Serrure à verrouillage multiple
 Multipoint lock

Zweiflügelige Türen,
 einwärts öffnend,
 Flügelhöhe ≤ 2500 mm

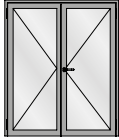
Porte à deux vantaux,
 ouvrant vers l'intérieur,
 hauteur du vantail ≤ 2500 mm

Double leaf door,
 inward opening,
 leaf height ≤ 2500 mm

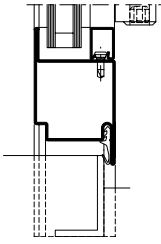
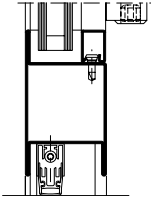
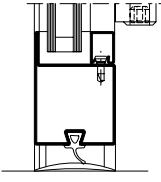
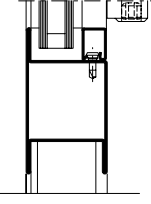
Variante		Beschlag Ferrure Fitting	 EN 12207	 EN 12208	 EN 12210
Anschlagdichtung Joint de butée Rebate gasket		①	1	0	C2
		②	2	0	C2
Senkdichtung Joint seuil Drop seal		①	1	0	C2
		②	2	0	C2
Auflaufdichtung Joint de contact Ramp seal		①	1	0	C2
		②	1	0	C2
		①	npd	npd	C1
		②	npd	npd	C1

Die Werte gelten für Trocken- und Nassverglasung

Les valeurs sont valables pour vitrage à sec et vitrage à mastic

The values are valid for dry glazing and glazing with sealing

U_f-Werte
(nach EN ISO 10077-2:2018-01)

Auf den folgenden Seiten finden Sie die U_f-Werte für die verschiedenen Anwendungen von Jansen-Economy 50.

Sie basieren auf folgenden Grundlagen:

Stahl

- Profile bandverzinkter Stahl, unbeschichtet
- Stahl-Glasleisten
- Trockenverglasung
- Nassverglasung

Edelstahl

- Profile Edelstahl, blank
- Edelstahl-Glasleisten
- Trockenverglasung
- Nassverglasung

Valeurs U_f
(selon EN ISO 10077-2:2018-01)

Vous trouverez les valeurs U_f pour les différentes applications Jansen-Economy 50 dans les pages qui suivent.

Elles se basent sur les principes suivants:

Acier

- Profilés en bande d'acier zingué, sans revêtement
- Parcloses en acier
- Vitrage à sec
- Vitrage à mastic

Acier Inox

- Profilés en acier Inox, brut
- Parcloses en acier Inox
- Vitrage à sec
- Vitrage à mastic

U_f values
(according to
EN ISO 10077-2:2018-01)

On the following pages you will find the U_f values for the various applications for Jansen-Economy 50.

They are based on the following:

Steel

- Strip galvanised steel profiles, uncoated
- Steel glazing beads
- Glazing with dry glazing
- Glazing with sealing

Stainless steel



- Stainless steel profiles, bright
- Stainless steel glazing beads
- Glazing with dry glazing
- Glazing with sealing

U_f-Werte
 (nach EN ISO 10077-2:2018-01)

Valeurs U_f
 (selon EN ISO 10077-2:2018-01)

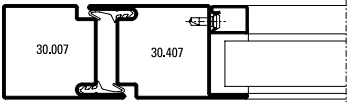
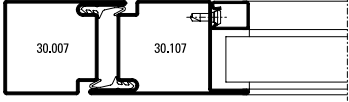
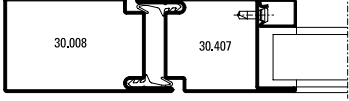
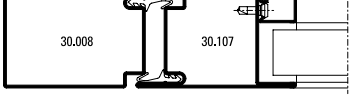
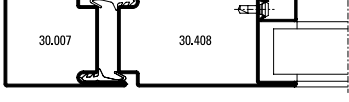
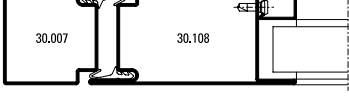
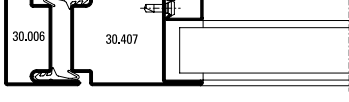
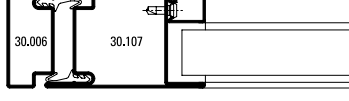
U_f values
 (according to EN ISO 10077-2:2018-01)

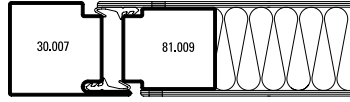
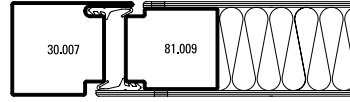
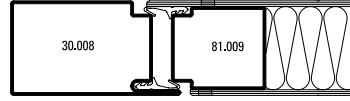
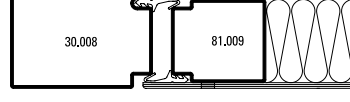
	Füllelementstärken Elements de remplissages Infill elements ≥ 24 mm
	5,4 W/m ² K
	5,4 W/m ² K
	5,2 W/m ² K
	5,2 W/m ² K
	5,1 W/m ² K
	5,2 W/m ² K
	5,5 W/m ² K
	5,5 W/m ² K

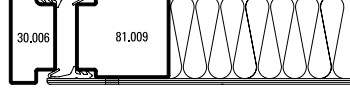
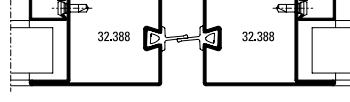
	Füllelementstärken Elements de remplissages Infill elements ≥ 24 mm
	5,3 W/m ² K
	5,3 W/m ² K
	5,1 W/m ² K
	5,1 W/m ² K
	5,4 W/m ² K
	5,4 W/m ² K
	6,6 W/m ² K

U_f-Werte
 (nach EN ISO 10077-2:2018-01)

Valeurs U_f
 (selon EN ISO 10077-2:2018-01)

U_f values
 (according to EN ISO 10077-2:2018-01)

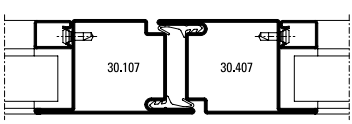
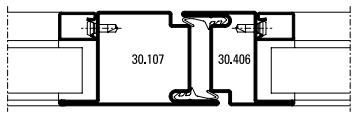
	Füllelementstärken Elements de remplissages Infill elements $\geq 24 \text{ mm}$
	5,5 W/m²K
	5,8 W/m²K

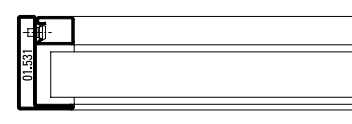
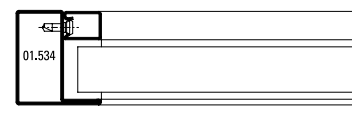
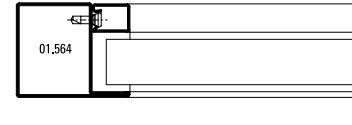
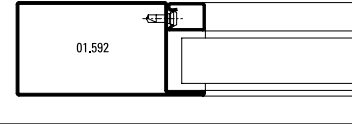
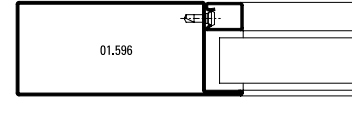
	Füllelementstärken Elements de remplissages Infill elements $\geq 24 \text{ mm}$
	7,3 W/m²K
	6,5 W/m²K
	6,0 W/m²K
	5,2 W/m²K
	4,9 W/m²K

U_f-Werte
 (nach EN ISO 10077-2:2018-01)

Valeurs U_f
 (selon EN ISO 10077-2:2018-01)

U_f values
 (according to EN ISO 10077-2:2018-01)

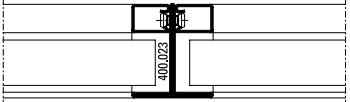
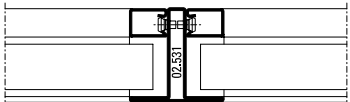
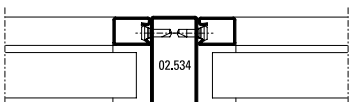
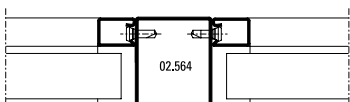
	Füllelementstärken Elements de remplissages Infill elements ≥ 24 mm
	7,5 W/m²K
	7,2 W/m²K
	6,6 W/m²K
	6,1 W/m²K

U_f-Werte
 (nach EN ISO 10077-2:2018-01)

Valeurs U_f
 (selon EN ISO 10077-2:2018-01)

U_f values
 (according to EN ISO 10077-2:2018-01)

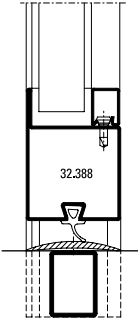
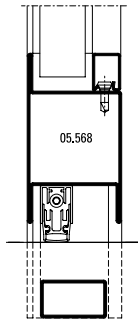
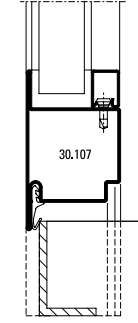
	Füllelementstärken Elements de remplissages Infill elements ≥ 24 mm
	5,4 W/m ² K
	5,4 W/m ² K
	5,4 W/m ² K

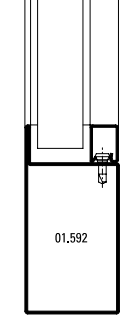
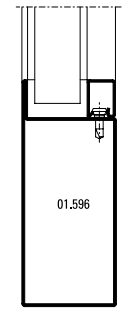
	Füllelementstärken Elements de remplissages Infill elements ≥ 24 mm
	5,2 W/m ² K
	4,9 W/m ² K

Leistungseigenschaften nach EN 14351-1
Caractéristiques de performance selon EN 14351-1
Performance characteristics according to EN 14351-1

Jansen-Economy 50 Türen
 Jansen-Economy 50 portes
 Jansen-Economy 50 doors

U_f-Werte
 (nach EN ISO 10077-2:2018-01)

Valeurs U_f
 (selon EN ISO 10077-2:2018-010)

U_f values
 (according to EN ISO 10077-2:2018-01)

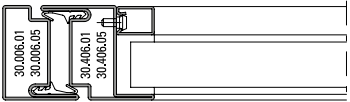
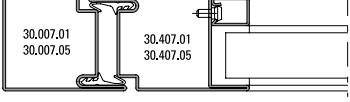
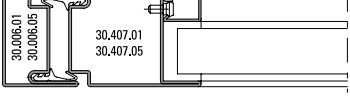
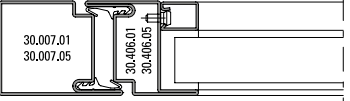
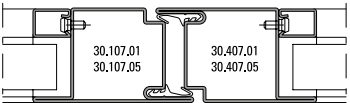

 © ift Rosenheim	Füllelementstärken Elements de remplissages Infill elements ≥ 24 mm
	5,0 W/m²K
	4,4 W/m²K
	4,6 W/m²K
	4,7 W/m²K
	4,6 W/m²K

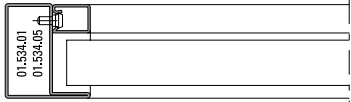
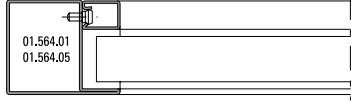
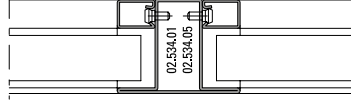
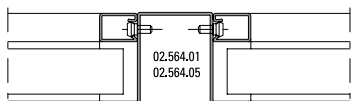
 © ift Rosenheim	Füllelementstärken Elements de remplissages Infill elements ≥ 24 mm
	5,6 W/m²K
	5,0 W/m²K
	5,5 W/m²K
	5,0 W/m²K

Leistungseigenschaften nach EN 14351-1
Caractéristiques de performance selon EN 14351-1
Performance characteristics according to EN 14351-1

Jansen-Economy 50 Türen
 Jansen-Economy 50 portes
 Jansen-Economy 50 doors

U_f-Werte
 (nach EN ISO 10077-2:2018-01)

Valeurs U_f
 (selon EN ISO 10077-2:2018-01)

U_f values
 (according to EN ISO 10077-2:2018-01)



	Füllelementstärken Elements de remplissages Infill elements ≥ 24 mm
	4,6 W/m²K



Schallschutz

Ausführungsvarianten

Die nachfolgende Typenübersicht ergibt einen Überblick über die beurteilten Varianten.

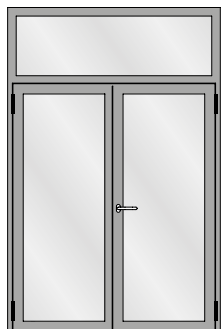
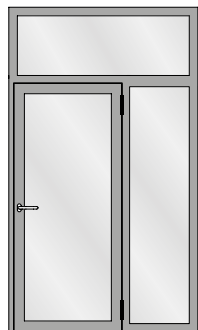
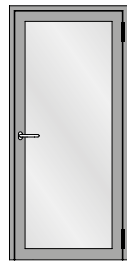

Isolation phonique

Modèles

L'aperçu des types suivant fournit une vue d'ensemble des variantes examinées.

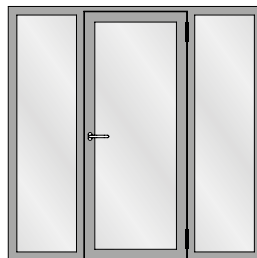
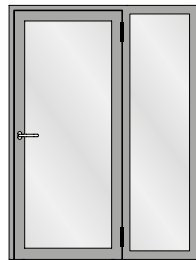
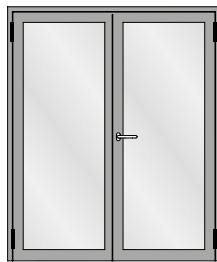

Sound insulation

Design range

The following overview of types provides an overview of the evaluated designs.

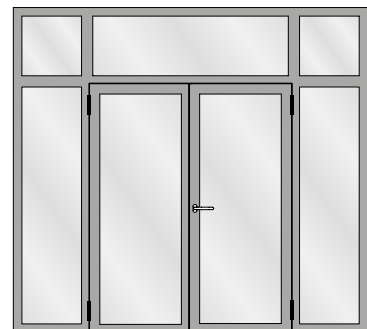
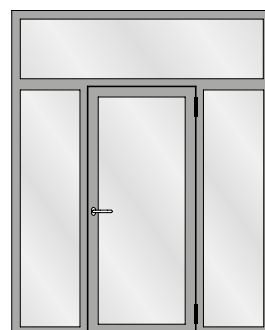

Schallschutz

Isolation phonique

Sound insulation

Tabelle A1

Korrekturtabelle für Jansen-Economy-Türen mit Glasfüllungen

Tableau A1

Tableau de correction pour les portes Jansen-Economy avec vitrage

Table A1

Correction table for Jansen-Economy doors with glass

	1	2	3	4	5	6	7	8	9	10	11
	Türe mit zwei absenkba- ren Bodendichtungen Porte avec deux joint seuil automatique Door with two threshold gaskets that can be lowered	Glas Verre Glass	Korrekturen Corrections Corrections								
	R_w (C, Ctr) dB	$R_{w, P, Glas}$ dB	K_S dB	K_{FV} dB	K_{Nass} dB	K_{1aB} dB	$K_{W/S}$ dB	$K_{G 0,4}$ dB	$K_{G 1,8}$ dB	$K_{G 2,6}$ dB	$K_{G 3,2}$ dB
1	32 (-1; -5)	31	0	-1	0	0	0	0	-1	-2	-3
2	33 (-1; -5)	32	0	-1	0	0	0	0	-1	-2	-3
3	35 (-1; -5)	34	0	-1	0	0	0	0	-1	-2	-3
4	36 (-2; -5)	35	0	-1	-1	0	0	0	-1	-2	-3
5	37 (-2; -5)	37	0	0	-1	0	-1	0	-1	-2	-3
6	38 (-2; -5)	39	0	0	-1	-1	-1	0	-1	-2	-3
7	39 (-2; -5)	40	0	0	-1	-1	-1	0	-1	-2	-3
8	40 (-2; -5)	41	0	0	-1	-1	-2	-1	-1	-2	-3
9	41 (-2; -5)	42	0	0	-1	-1	-2	-2	-1	-2	-3
10	42 (-2; -5)	43	-1	0	-1	-1	-2	-2	-1	-2	-3
11	42 (-2; -5)	44	-1	0	-1	-1	-2	-2	-1	-2	-3
12	43 (-2; -5)	45	-1	+1	-1	-1	-3	-3	-1	-2	-3
13	44 (-2; -5)	49	-1	+1	-1	-2	-3	-3	-1	-2	-3

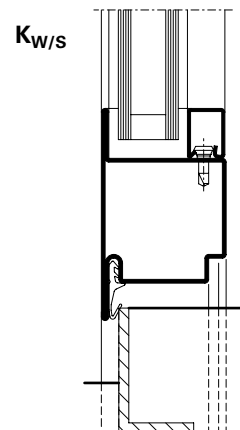
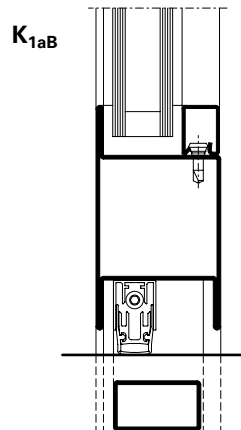
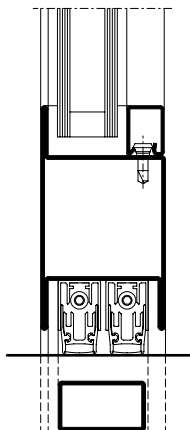

Schallschutz

Isolation phonique

Sound insulation

Der aus der Tabelle A1 abzulesende Wert für die Schalldämmung $R_{w, Tür}$ beträgt:

La valeur à relever sur le tableau A1 concernant l'isolement contre les sons aériens $R_{w, Porte}$ est la suivante:

The value taken from table A1 for the sound insulation $R_{w, Door}$ is:

$$R_{w, Tür} = R_w + K_S + K_{FV} + K_{Nass} + K_{1aB} + K_{W/S} + K_{Band} + K_{G 0,4} + K_{G 1,8} + K_{G 2,6} + K_{G 3,2} \text{ dB}$$

R_w bewertetes Schalldämm-Mass der Türe in Abhängigkeit von der Schalldämmung $R_{w,P, Glas}$

$R_{w,P, Glas}$ bewertetes Schalldämm-Mass der Verglasung (Prüfwert nach ISO 140-3, mit Prüfnachweis einer PÜZ-Stelle). Alternativ können Tabellenwerte nach DIN EN 12758, Abschnitt 6 verwendet werden

K_S Korrekturwert für zweiflügelige Türen

K_{FV} Korrekturwert für Festverglasungen mit erhöhtem Scheibenanteil

K_{Nass} Korrekturwert für Nassverglasung

K_{1aB} Korrekturwert für Türen mit einer absenkbaren Bodendichtung

K_{Band} Korrekturwert bei Verwendung von Anschlagbändern, die eine Dichtungsebene unterbrechen ($K_{Band} = - 0,5 \text{ dB pro Band}$)

$K_{W/S}$ Korrekturwert für Türen mit einer Anschlagsschwelle

$K_{G 0,4}$ Korrekturwert für Einzelscheiben mit einer Glasfläche $\leq 0,4 \text{ m}^2$. Die Korrektur gilt auch für Konstruktionen mit glasteilenden Sprossen.

$K_{G 1,8}$ Korrekturwert für Einzelscheiben mit einer Glasfläche $\geq 1,8 \text{ m}^2$

$K_{G 2,6}$ Korrekturwert für Einzelscheiben mit einer Glasfläche $\geq 2,6 \text{ m}^2$

$K_{G 3,2}$ Korrekturwert für Einzelscheiben mit einer Glasfläche $\geq 3,2 \text{ m}^2$

R_w Mesure d'isolement contre les sons aériens des portes évaluée suivant l'isolement phonique $R_{w,P, Glas}$

$R_{w,P, Glas}$ Cote d'isolement acoustique du vitrage évalué (valeur contrôlée selon ISO 140-3 avec certificat d'un bureau de contrôle, de surveillance ou de certification). Il est également possible d'utiliser les valeurs selon le tableau DIN EN 12758, section 6

K_S Valeur de correction pour portes à deux vantaux

K_{FV} Valeur de correction pour vitrages fixes à fort pourcentage de vitre

K_{Nass} Valeur de correction pour vitrage avec mastic

K_{1aB} Valeur de correction pour portes avec un joint seuil automatique

K_{Band} Valeur corrective en cas d'utilisation de paumelles qui interrompent un plan d'étanchéité ($K_{Band} = - 0,5 \text{ dB par paumelle}$)

$K_{W/S}$ Valeur de correction pour portes avec un seuil de butée

$K_{G 0,4}$ Valeur de correction pour vitres individuelles avec une surface vitrée $\leq 0,4 \text{ m}^2$. La correction s'applique aussi aux constructions à meneaux séparant les vitres.

$K_{G 1,8}$ Valeur de correction pour vitres individuelles avec surface vitrée $\geq 1,8 \text{ m}^2$

$K_{G 2,6}$ Valeur de correction pour vitres individuelles avec surface vitrée $\geq 2,6 \text{ m}^2$

$K_{G 3,2}$ Valeur de correction pour vitres individuelles avec surface vitrée $\geq 3,2 \text{ m}^2$

R_w Airborne sound reduction index of doors depending on the sound insulation $R_{w,P, Glas}$

$R_{w,P, Glas}$ Airborne sound reduction index (test value in accordance with ISO 140-3, with a test certificate from a recognised testing, inspection or certification body). Alternatively, the tabulated values in DIN EN 12758, Section 6 may be used

K_S Correction value for double-leaf doors

K_{FV} Correction value for fixed glazing with increased proportion of pane

K_{Nass} Correction value for glazing with sealing

K_{1aB} Correction value for doors with a threshold gasket that can be lowered

K_{Band} Correction value when using hinges that interrupt a sealing plane ($K_{Band} = - 0.5 \text{ dB per hinge}$)

$K_{W/S}$ Correction value for doors with a rebate threshold

$K_{G 0,4}$ Correction value for single panes with a glass area $\leq 0,4 \text{ m}^2$. The correction also applies to buildings with glazing bars

$K_{G 1,8}$ Correction value for single panes with a glass area $\geq 1,8 \text{ m}^2$

$K_{G 2,6}$ Correction value for single panes with a glass area $\geq 2,6 \text{ m}^2$

$K_{G 3,2}$ Correction value for single panes with a glass area $\geq 3,2 \text{ m}^2$