

VISS Dachverglasung

Wärmegeämmte Dachverglasungen

Verrière VISS

Verrières à rupture de pont thermique

VISS roof glazing

Thermally insulated roof glazings

Inhaltsverzeichnis**Sommaire****Content**

VISS Dachverglasung

Verrière VISS

VISS roof glazing

SystemübersichtMerkmale
Zulassungen**Sommaire du système**Caractéristiques
Homologations**Summary of system**Characteristics
Authorisations**2**

ProfilsortimentProfile 50 und 60 mm
Deckprofile 50 und 60 mm**Assortiment de profilé**Profilés 50 et 60 mm
Profilés de recouvrement 50 et 60 mm**Range of profiles**Profiles 50 and 60 mm
Cover sections 50 and 60 mm**7**

Konstruktions-HinweiseSchnittpunkte
Konstruktionsdetails
Anschlüsse am Bau
Systemhinweise**Indications du construction**Coupes de détails
Détails de construction
Raccordement au mur
Remarques concernant les systèmes**Construction instructions**Section details
Construction details
Attachment to structure
System instructions**13**

Alle Ausführungen dieser Dokumentation haben wir sorgfältig und nach bestem Wissen zusammengestellt. Wir können aber keine Verantwortung für die Benutzung der vermittelten Vorschläge und Daten übernehmen. Wir behalten uns technische Änderungen ohne Vorankündigung vor.
Aktuelle Version auf www.jansen.com

Nous avons apporté le plus grand soin à l'élaboration de cette documentation. Cependant, nous déclinons toute responsabilité pour l'utilisation faite de nos propositions et de nos données.
Nous nous réservons le droit de procéder à des modifications techniques sans préavis.
Version actuelle sur www.jansen.com

All the information contained in this documentation is given to the best of our knowledge and ability. However, we decline all responsibility for the use made of these suggestions and data.
We reserve the right to effect technical modifications without prior warning.
Current version available at www.jansen.com





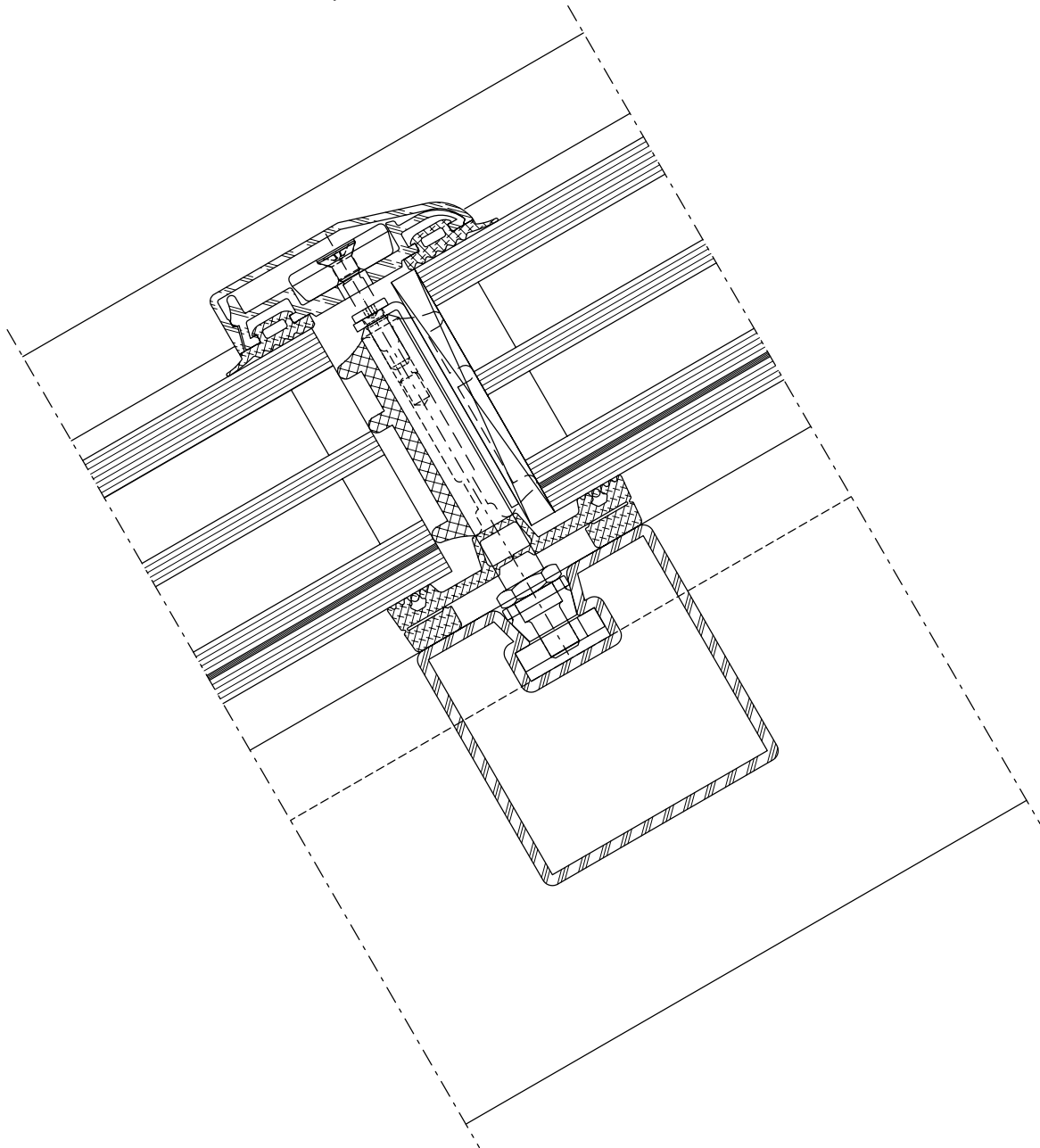

Merkmale
Caractéristiques
Characteristics

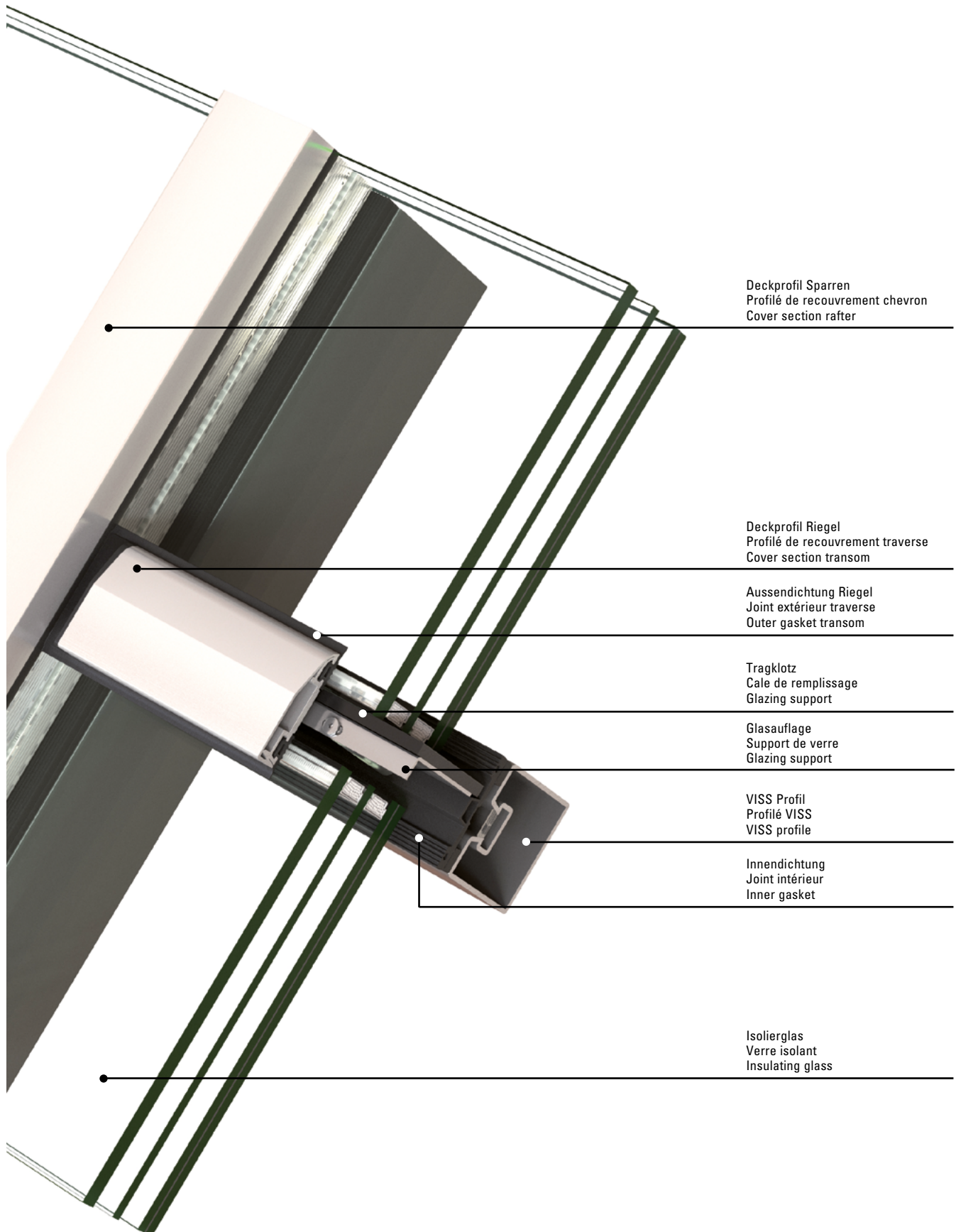
VISS Dachverglasung
Verrière VISS
VISS roof glazing

- U_f Werte bis 0,5 W/m²K
- Ansichtsbreiten 50 und 60 mm
- Füllelementstärken 16 bis 70 mm
- Standardprofile ab Lager mit I_x Werten bis 2041 cm⁴
- Alle gängigen Dachtypen wie Pyramiden, Kuppeln, Schrägdach, Giebelverglasungen, Pultdachverglasungen
- Schrägverglasungen mit Neigungswinkel von 10° bis 75° (Innenbereich von 0° bis 75°)
- Valeurs U_f jusqu'à 0,5 W/m²K
- Largeurs de face 50 et 60 mm
- Éléments de remplissage de 16 à 70 mm d'épaisseur
- Profilés standard disponibles en magasin avec valeurs I_x jusqu'à 2041 cm⁴
- Tous les types usuels de toit tels que pyramide, coupole, vitrages de pignon, vitrages de toit en appentis
- Vitrages inclinés dont l'angle d'inclinaison est de 10° à 75° (intérieur également de 0° à 75° possible)
- U_f values to 0,5 W/m²K
- 50 and 60 mm face widths
- Infill panel thicknesses of 16 to 70 mm
- Standard profiles from stock with I_x values to 2041 cm⁴
- All standard roof types such as pyramids, domes, pitched roofs, gable glazing, mono-pitch roof glazing
- Inclined glazing at angle of 10° to 75° (0° to 75° also possible for inside area)





Prüfungen (Prüfnorm) Essais (Norme d'essai) Tests (Test standard)	Klassifizierungsnorm Norme de classification Classification standard	Werte Valeurs Values
 Schlagregendichtheit (EN 12155) Etanchéité à la pluie battante (EN 12155) Watertightness (EN 12155)	EN 12154	RE 1200 Wassermenge 3 l/m ² - min* Quantité d'eau 3 l/m ² - min* Water quantity 3 l/m ² - min*
 Widerstand bei Windlast (EN 12179) Résistance à la pression du vent (EN 12179) Resistance to wind load (EN 12179)	EN 13116	Bemessungslast 2 kN/m ² Charge de calcul 2 kN/m ² Designed load 2 kN/m ²
 Luftdurchlässigkeit (EN 12153) Perméabilité à l'air (EN 12153) Air permeability (EN 12153)	EN 12152	AE 750
 Wärmedurchgangskoeffizient (EN 13947) Transmission thermique (EN 13947) Thermal production (EN 13947)	EN ISO 10077-2	ab $U_f > 0,50 \text{ W/m}^2\text{K}$ dès $U_f > 0,50 \text{ W/m}^2\text{K}$ from $U_f > 0,50 \text{ W/m}^2\text{K}$
 Sicherheitsprüfung Contrôle de sécurité Security test	EN 13116	3000 Pa
 Sicherheitsprüfung Aufpralllast Essai de choc de corps mou sur élément de verrière Soft body impact test on roof glazing element	CSTB 3228	Anforderung erfüllt Exigence remplie Requirement satisfied

* Werte geprüft in Anlehnung der Produktnorm für Vorhangfassaden EN 13830. Wassermenge 3 l/m² anstelle 2 l/m².

* Valeurs contrôlées en référence à la norme de produit sur les façades EN 13830. Quantité d'eau 3 l/m² au lieu de 2 l/m².

* Values tested on the basis of product standard EN 13830. Water quantity 3 l/m² instead of 2 l/m².

Jansen Docu Center

Die Plattform zum effizienten Arbeiten mit Jansen Dokumentationen. Im Jansen Docu Center stehen alle Produktinformationen jederzeit digital in der aktuellsten Version zur Verfügung: von Architekten-Informationen über Bestell- und Fertigungskatalogen bis hin zu Anleitungen und Prospekten sowie Videos.

Die Inhalte können einfach und schnell aufgerufen werden. Ein für den Anwender komfortables papierloses Arbeiten, das zahlreiche Vorteile bietet.

Jansen Docu Center

La plate-forme pour travailler efficacement avec les documentations Jansen. Le Jansen Docu Center met à votre disposition les informations sur les produits, en format numérique et dans une version actualisée: des catalogues de commande et de fabrication aux instructions et prospectus, en passant par les informations destinées aux architectes et vidéos.

Les contenus sont facilement et rapidement accessibles. Une manière de travailler confortable et offrant de nombreux avantages.

Jansen Docu Center

The platform for working efficiently with Jansen documentation. The latest version of all the product information is available digitally at any time in the Jansen Docu Center – from order and fabrication manuals to architect information, instructions and brochures and videos.

The content can be retrieved quickly and easily. The user can work conveniently without paper, which has numerous benefits.

Download CAD Daten

DXF

DWG

Sie können die Zeichnungen in den Formaten DXF und/oder DWG herunterladen. Klicken Sie auf das entsprechende Icon und der Download erfolgt.

Die Hinweise «Artikelbibliothek/Türbeschläge/Fensterbeschläge» bedeuten, dass Sie mit einem Klick die gesamte Artikelbibliothek des entsprechenden Systems herunterladen (Profile, Beschläge, Glasleisten, Zubehör etc.).

Info und Beratung

Gerne beraten wir Sie persönlich und stehen Ihnen bei Fragen zur Verfügung. Bitte schreiben Sie uns Ihre Anliegen an: info@jansen.com

Télécharger fichiers DAO

DXF

DWG

Vous pouvez télécharger les dessins aux formats DXF et/ou DWG. Cliquez sur l'icône correspondante et le téléchargement s'effectuera.

Les indications «Bibliothèque des articles/Ferures de porte/Ferrures de fenêtres» signifie que vous téléchargez la totalité de la bibliothèque des articles du système donné (profilés, ferrures, parclose, accessoires etc.).

Info et conseils

Nous vous conseillerons volontiers individuellement et sommes à votre disposition si vous avez des questions à poser. Veuillez nous envoyer votre requête à: info@jansen.com

Download CAD files

DXF

DWG

You can download the drawings in DXF and/or DWG format. Click on the relevant icon to begin the download.

The items «Article library/Door fittings/Window fittings» means that you download the entire article library for the corresponding system with one click (profiles, fittings, glazing beads, accessories etc.).

Information and advice

We would be delighted to provide you with advice in person and are available to answer any questions you may have. Please write to us with your queries at: info@jansen.com

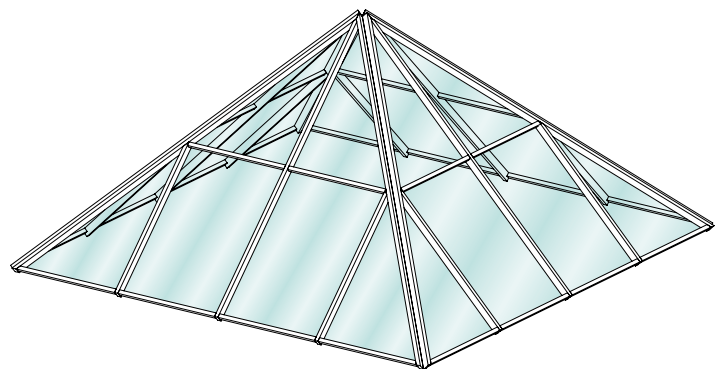
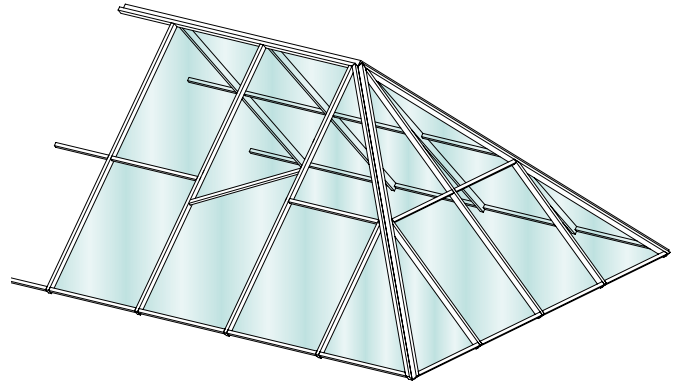
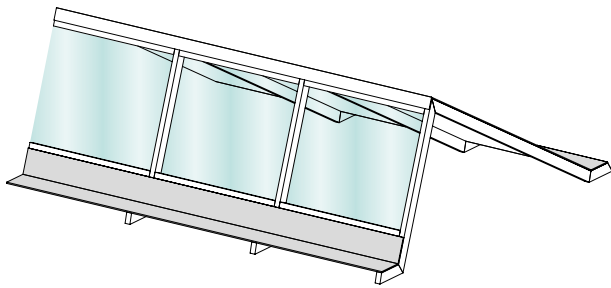
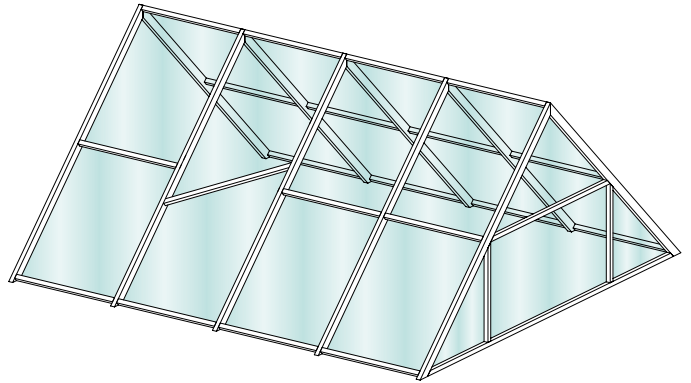
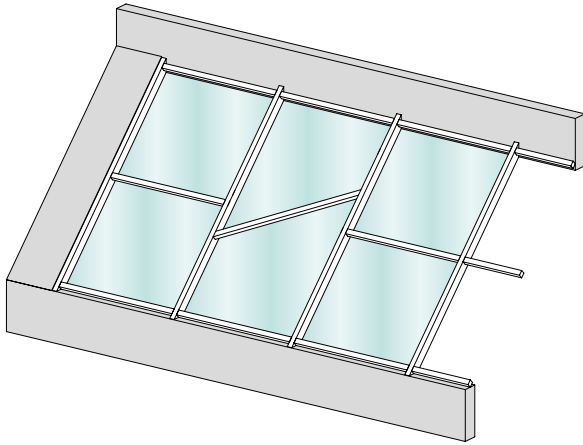

Profile 50 mm (Massstab 1:3)

Profils 50 mm (échelle 1:3)

Profiles 50 mm (scale 1:3)

VISS Dachverglasung

Verrière VISS

VISS roof glazing

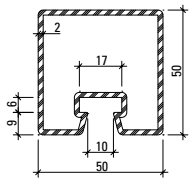

76.694
76.694 Z

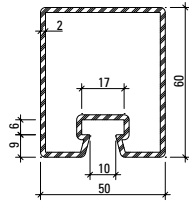

76.671
76.671 Z

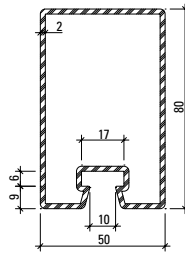

76.696
76.696 Z

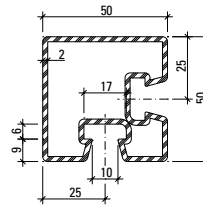

76.094

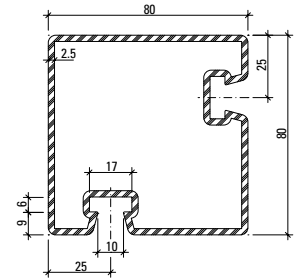

76.096

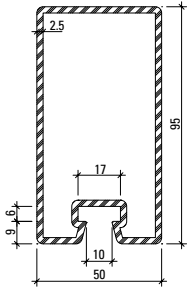

76.697
76.697 Z

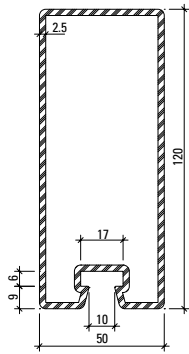

76.679
76.679 Z

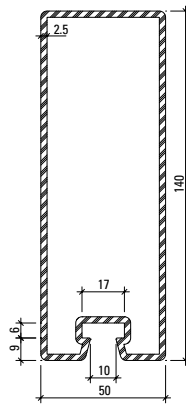

76.666
76.666 Z

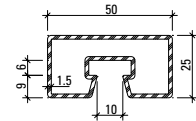

76.682

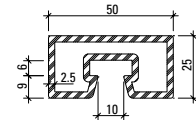

76.680

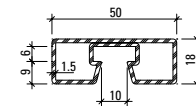

76.692

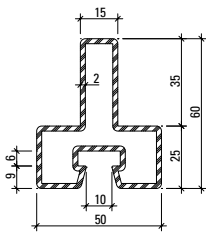

76.114

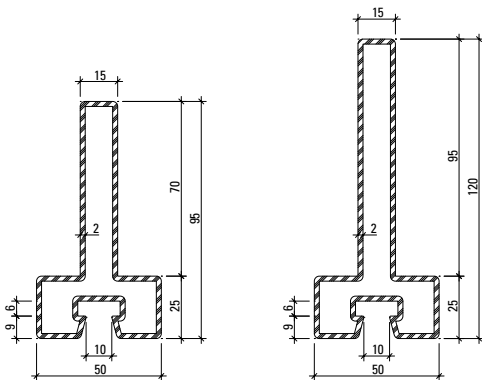

76.115

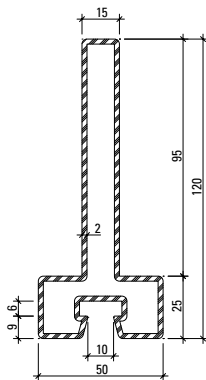

76.116

Profil-Nr.	G kg/m	F cm ²	I _x cm ⁴	W _x cm ³	I _y cm ⁴	W _y cm ³	U m ² /m	L mm
76.094	4,090	5,2	15,2	5,8	15,2	5,8	0,280	6000
76.096	7,437	9,5	83,8	20,5	83,8	20,5	0,391	6000
76.666	7,910	10,1	241,3	32,3	43,7	17,5	0,412	6500
76.671	3,860	4,9	23,3	7,2	17,3	6,9	0,260	6500
76.679	7,120	9,1	162,2	25,2	37,9	15,2	0,373	6500
76.680	3,390	4,3	3,2	2,4	11,1	4,4	0,182	6100
76.682	2,120	2,7	2,2	1,7	7,2	2,9	0,190	6000
76.692	1,900	2,5	0,9	1,0	5,9	2,4	0,176	6000
76.694	3,500	4,5	14,7	5,6	15,0	6,0	0,240	6500
76.696	4,450	5,7	47,6	11,1	21,9	8,8	0,300	6500
76.697	6,100	7,9	90,2	17,6	31,0	12,4	0,330	6500
76.114	3,820	4,9	15,4	4,1	9,8	3,9	0,251	6000
76.115	4,920	6,3	54,8	9,3	10,4	4,2	0,321	6000
76.116	5,710	7,3	105,0	14,3	10,8	4,3	0,371	6000

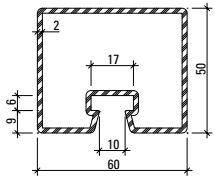

76.695
76.695 Z

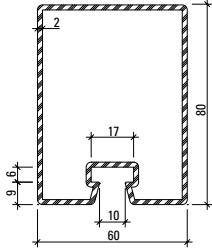

76.678
76.678 Z

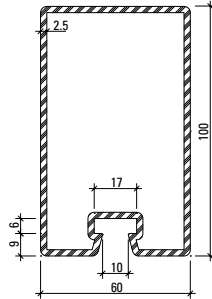

76.684
76.684 Z

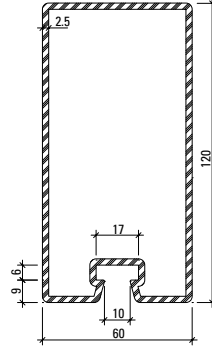

76.698
76.698 Z

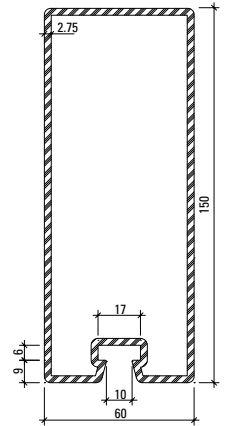

76.667
76.667 Z

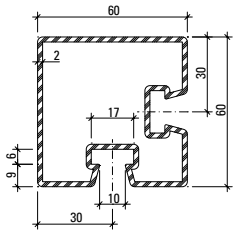

76.095

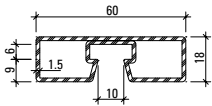

76.693

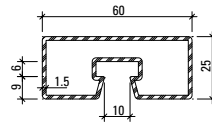

76.683

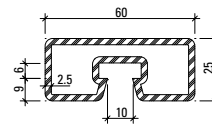

76.681

Artikelbibliothek
 Bibliothèque des articles
 Article library

DXF **DWG**

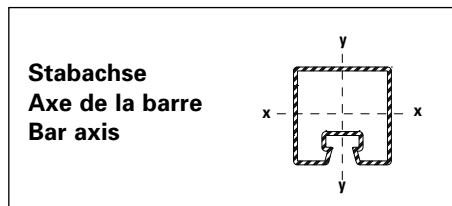

Profil-Nr.	G kg/m	F cm ²	I _x cm ⁴	W _x cm ³	I _y cm ⁴	W _y cm ³	U m ² /m	L mm
76.095	4,750	6,1	27,2	8,6	27,2	8,6	0,311	6000
76.667	9,530	12,1	342,8	43,0	75,1	25,0	0,452	6500
76.678	4,800	6,1	53,9	12,6	32,8	11,0	0,320	6500
76.681	3,790	4,8	3,8	2,9	17,3	5,8	0,202	6100
76.683	2,360	3,0	2,6	2,0	11,1	3,7	0,210	6000
76.684	6,730	8,6	114,1	21,3	48,3	16,1	0,352	6500
76.693	2,140	2,8	1,3	1,3	9,3	3,1	0,196	6000
76.695	3,800	4,9	17,2	6,5	22,9	7,6	0,260	6500
76.698	7,500	9,7	179,6	28,0	56,6	18,9	0,400	6500

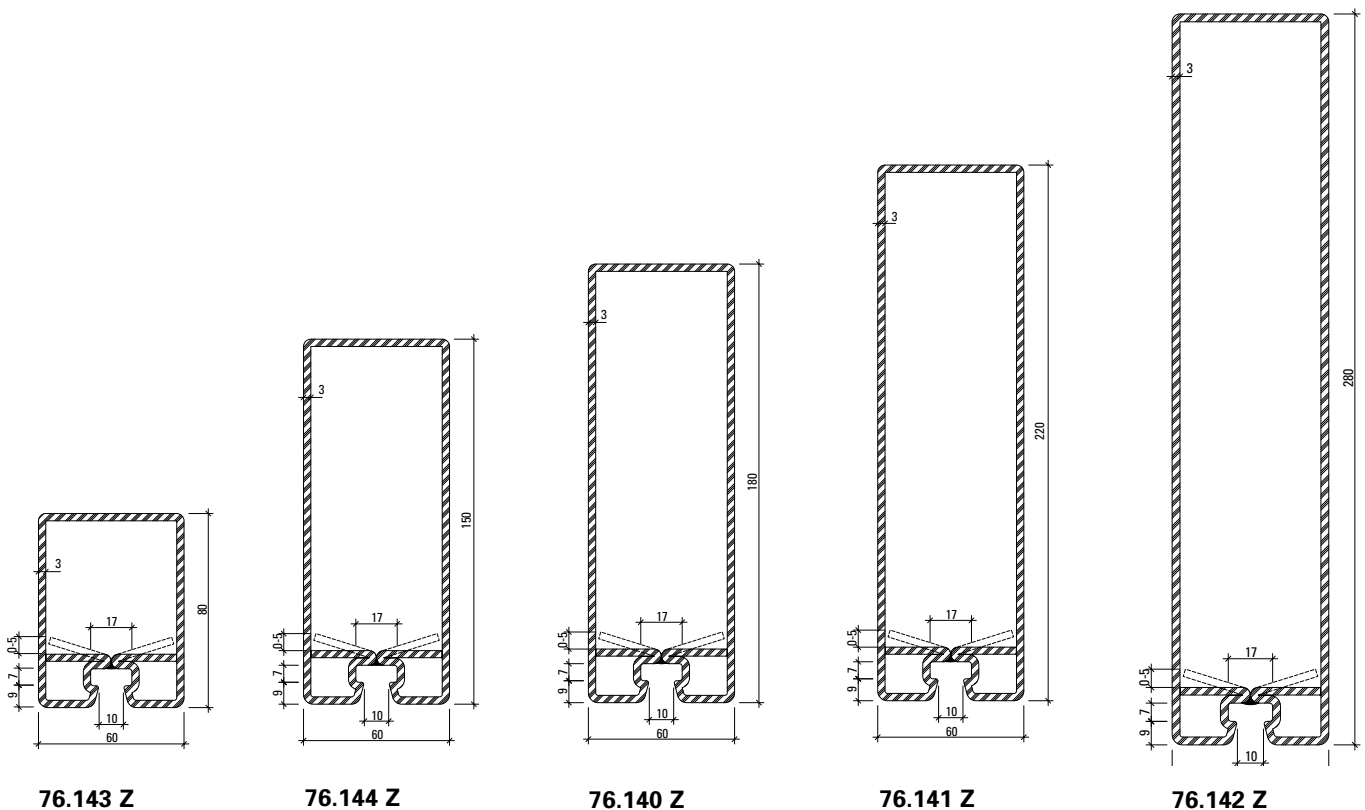

Aufgrund von Fertigungstoleranzen kann die Lage des Rückbogens von 0 bis 5 mm variieren.

En raison des tolérances de fabrication, la position du segment coudé peut varier de 0 à 5 mm.

Due to fabrication tolerances, the position of the rear arch may vary between 0 and 5 mm.

Oberfläche/Werkstoff

Artikel-Nr.

ohne Zusatz = blank

mit Z = bandverzinkter Stahl

Surface/Matériau

No. d'article

sans supplément = brut

avec Z = bandes d'acier zinguées

Surface/Material

Part no.

without addition = bright

with Z = galvanised strip

Artikelbibliothek
 Bibliothèque des articles
 Article library

DXF
DWG

Profil-Nr.	G kg/m	F cm ²	I _x cm ⁴	W _x cm ³	I _y cm ⁴	W _y cm ³	U m ² /m	L mm
76.140 Z	12,946	16,47	649,2	64,3	100,0	33,2	0,516	8000
76.141 Z	14.833	18.87	1090,2	89,1	119,1	39,7	0,596	8000
76.142 Z	17,662	22,5	2041,7	132,7	148,4	49,5	0,716	10000
76.143 Z	8.340	10.62	80,4	17,9	50,8	16,9	0,316	6500
76.144 Z	11.630	14.82	406,0	47,9	85,0	28,3	0,456	6500

Deckprofile 50 mm (Massstab 1:3)
Profils de recouvrement 50 mm (échelle 1:3)
Cover sections 50 mm (scale 1:3)

VISS Dachverglasung
 Verrière VISS
 VISS roof glazing

**Anpress- und Deckprofil
 Riegel**

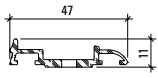

407.827

**Profilé de fixation et
 de recouvrement
 Traverse**

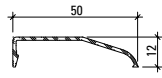

407.886

**Clamping and cover section
 Transom**

**Anpress- und Deckprofile
 Sparren**

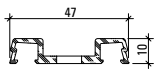

407.800

**Profilé de fixation et
 de recouvrement
 Chevron**

**Clamping and cover sections
 Rafter**

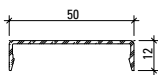

407.860

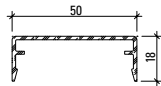

407.861

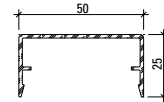

407.862

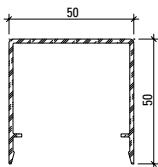

407.863

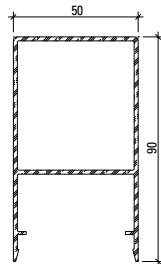

407.864

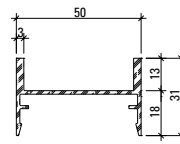

407.900

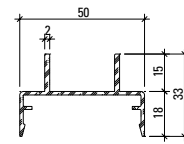

407.911

Werkstoff

Aluminium EN AW 6060 T66 roh, leicht eingeölt

Matériau

Aluminium EN AW 6060 T66 brut, légèrement huilé

Material

Aluminium EN AW 6060 T66 mill finish, slightly oiled

Profil-Nr.	G kg/m	U m ² /m	P m ² /m	L mm
407.800	0,414			6000
407.827	0,356			6000
407.860	0,266	0,147	0,072	6000
407.861	0,341	0,185	0,084	6000
407.862	0,394	0,213	0,098	6000

Profil-Nr.	G kg/m	U m ² /m	P m ² /m	L mm
407.863	0,660	0,313	0,148	6000
407.864	1,344	0,360	0,228	6000
407.886	0,230	0,131	0,062	6000
407.900	0,556	0,240	0,138	6000
407.911	0,510	0,245	0,146	6000

Deckprofile 50 mm (Masstab 1:3)
Profils de recouvrement 50 mm (échelle 1:3)
Cover sections 50 mm (scale 1:3)

VISS Dachverglasung
 Verrière VISS
 VISS roof glazing

**Edelstahl Deckprofile
Sparren**

**Profils de recouvrement acier Inox
Chevron**

**Stainless steel cover sections
Rafters**

Werkstoff 1.4301 (AISI 304)
 geschliffen, Korn 220/240,
 mit Schutzfolie

Qualité 1.4301 (AISI 304)
 meulé, degré 220/240,
 avec feuille de protection

Material 1.4301 (AISI 304)
 polished, grain 220/240,
 with protective film

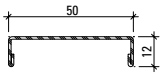

400.860

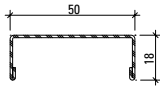

400.861



Werkstoff 1.4401 (AISI 316)
 geschliffen, Korn 220/240,
 mit Schutzfolie

Qualité 1.4401 (AISI 316)
 meulé, degré 220/240,
 avec feuille de protection

Material 1.4401 (AISI 316)
 polished, grain 220/240,
 with protective film

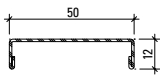

400.862

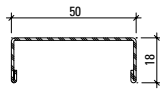

400.863



Profil-Nr.	G kg/m	L mm
400.860	0,644	6000
400.861	0,734	6000

Profil-Nr.	G kg/m	L mm
400.862	0,652	6000
400.863	0,744	6000

Deckprofile 60 mm (Massstab 1:3)

Profils de recouvrement 60 mm (échelle 1:3)

Cover sections 60 mm (scale 1:3)

VISS Dachverglasung

Verrière VISS

VISS roof glazing

Anpress- und Deckprofile
Sparren

Profilé de fixation et
de recouvrement
Chevron

Clamping and cover sections
Rafters

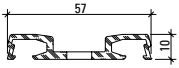

407.802

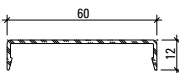

407.865

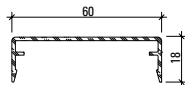

407.866

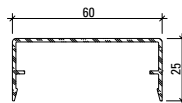

407.867

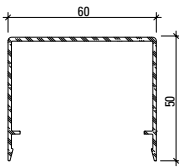

407.868

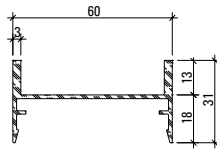

407.901

Werkstoff

Aluminium EN AW 6060 T66 roh,
leicht eingeölt

Matériau

Aluminium EN AW 6060 T66 brut,
légèrement huilé

Material

Aluminium EN AW 6060 T66 mill finish,
slightly oiled

Hinweis:

Im Riegel muss immer die 50 mm
Ansichtsbreite bei den Deck- und
Anpressprofilen verwendet werden.

Remarque:

Dans la traverse, il faut toujours
utiliser la largeur de face 50 mm
pour les profils de recouvrement
et d'application.

Note:

In the transom, the 50 mm face
width must always be used with
cover profiles and pressure plates.

Profil-Nr.	G kg/m	U m ² /m	P m ² /m	L mm
407.802	0,558	0,190		6000
407.865	0,304	0,167	0,082	6000
407.866	0,379	0,205	0,094	6000
407.867	0,432	0,223	0,108	6000

Profil-Nr.	G kg/m	U m ² /m	P m ² /m	L mm
407.868	0,750	0,330	0,160	6000
407.901	0,590	0,255	0,148	6000

Artikelbibliothek
Bibliothèque des articles
Article library

DXF

DWG

Schnittpunkte	Coupe de détails	Section details
Sparrendetail HI 50 mm	Détail du chevron HI 50 mm	Detail of rafter HI 50 mm
Riegeldetail HI 50 mm	Détail de la traverse HI 50 mm	Detail of transom HI 50 mm
Sparrendetail 50 mm	Détail du chevron 50 mm	Detail of rafter 50 mm
Riegeldetail 50 mm	Détail de la traverse 50 mm	Detail of transom 50 mm
Sparrendetail VISS Linea 50 mm	Détail du chevron VISS Linea 50 mm	Detail of rafter VISS Linea 50 mm
Sparrendetail HI 60 mm	Détail du chevron HI 60 mm	Detail of rafter HI 60 mm
Riegeldetail HI 60 mm	Détail de la traverse HI 60 mm	Detail of transom HI 60 mm

Konstruktionsdetails	Détails de constructions	Construction details
Firstdetail 90°	Détail du faite 90°	Ridge detail 90°
Gratdetail	Albalétriers	Angle rafter
Ortgang-Detail	Détail de la rive	Verge detail
Knickpunktdetail	Détail d'angle	Detail of corner

Anschlüsse am Bau	Raccords au mur	Attachment to structure
Systemhinweise	Remarques concernant les systèmes	System instructions
U _f -Werte nach EN 10077-2	Valeurs U _f selon EN 10077-2	U _f values according to EN 10077-2

Schnittpunkte im Massstab 1:1
Coupe de détails à l'échelle 1:1
Section details on scale 1:1

VISS Dachverglasung
Verrière VISS
VISS roof glazing

Sparrendetail HI
Ansichtsbreite 50 mm

Détail du chevron HI
Largeur de face 50 mm

Detail of rafter HI
Width 50 mm

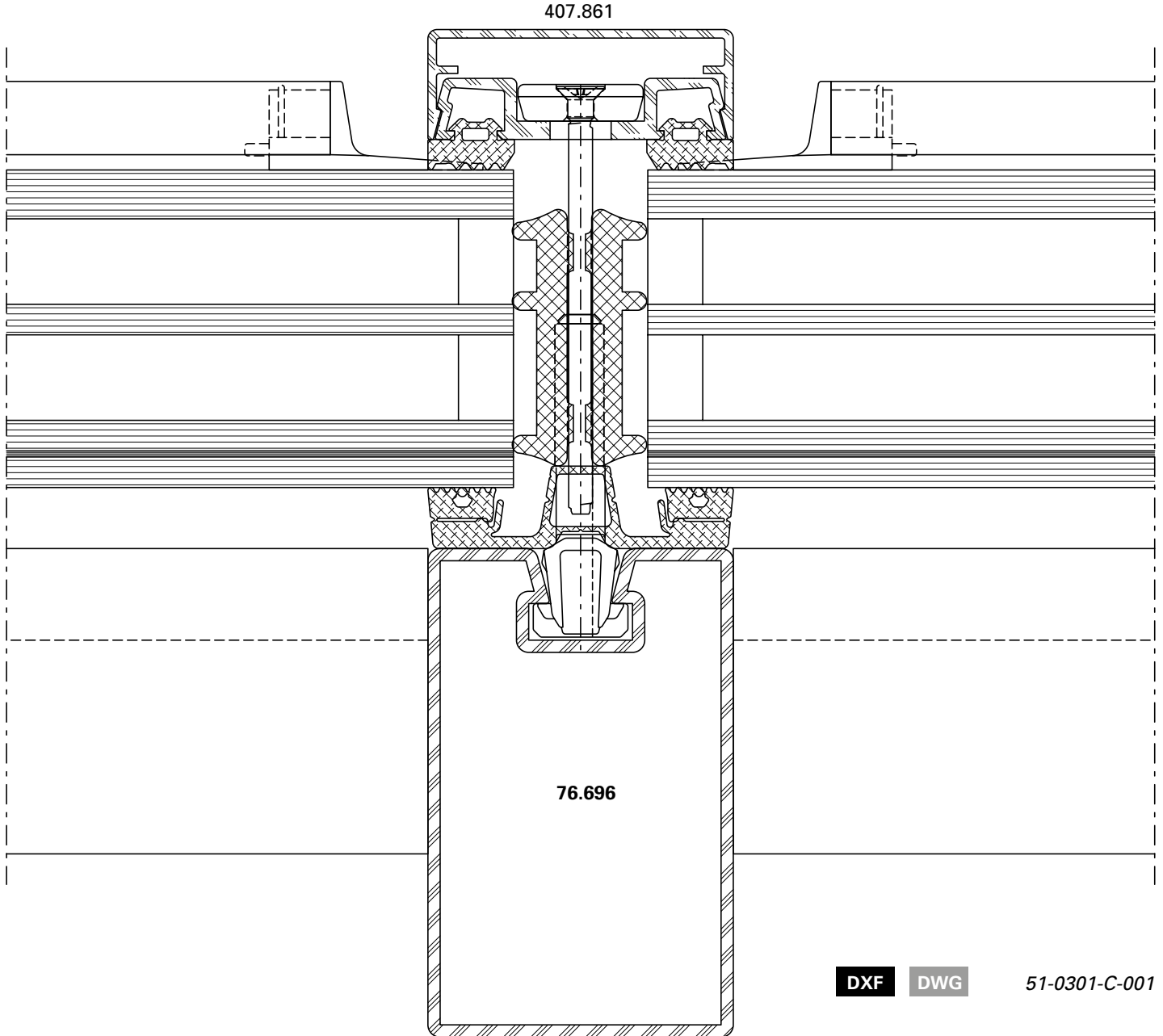

DXF DWG

51-0301-C-001

Schnittpunkte im Massstab 1:1
Coupe de détails à l'échelle 1:1
Section details on scale 1:1

VISS Dachverglasung
Verrière VISS
VISS roof glazing

Riegeldetail HI
Ansichtsbreite 50 mm

Détail de la traverse HI
Largeur de face 50 mm

Detail of transom HI
Width 50 mm

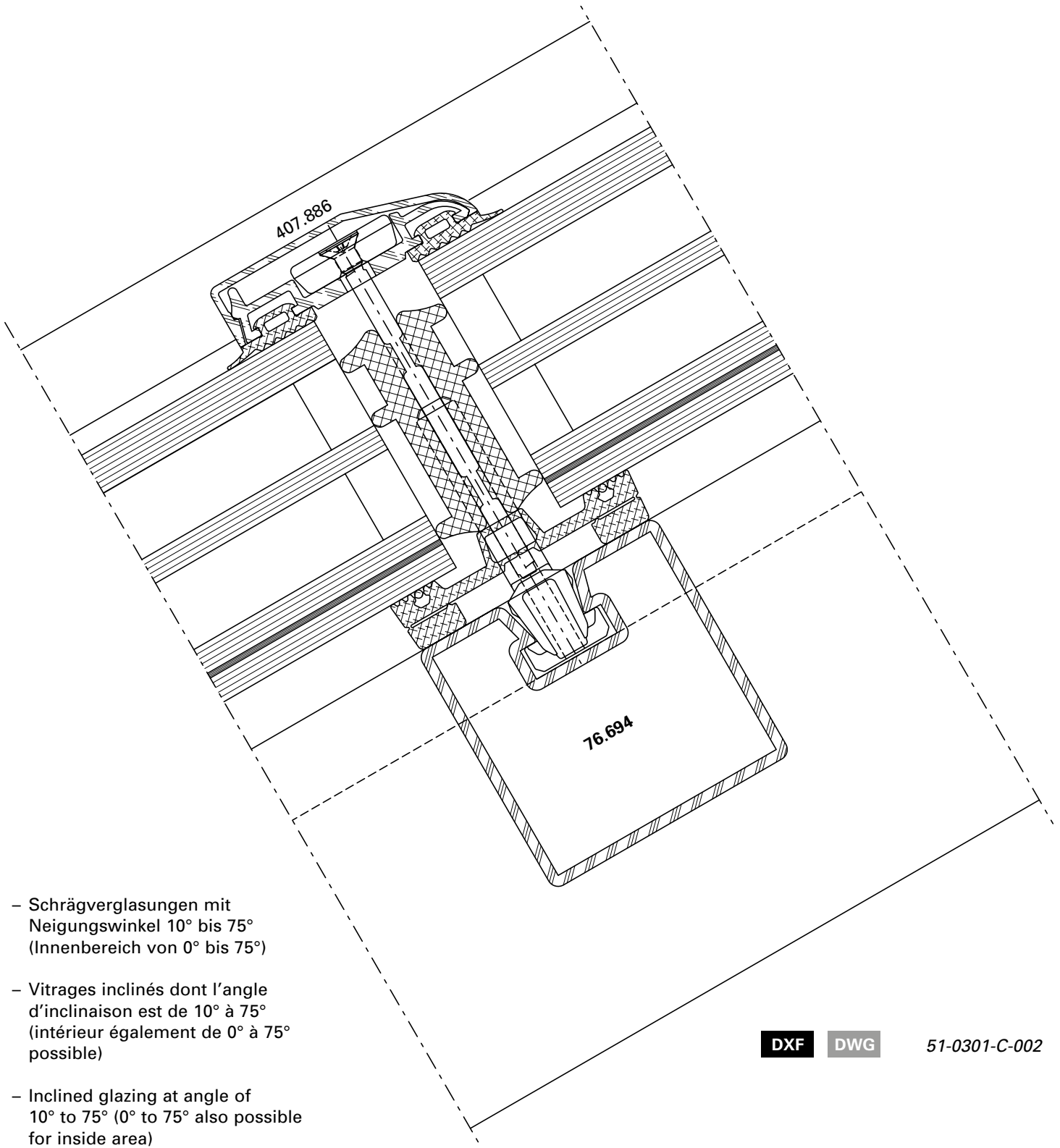

DXF

DWG

51-0301-C-002

Schnittpunkte im Massstab 1:1
Coupe de détails à l'échelle 1:1
Section details on scale 1:1

VISS Dachverglasung
Verrière VISS
VISS roof glazing

Sparrendetail
Ansichtsbreite 50 mm

Détail du chevron
Largeur de face 50 mm

Detail of rafter
Width 50 mm

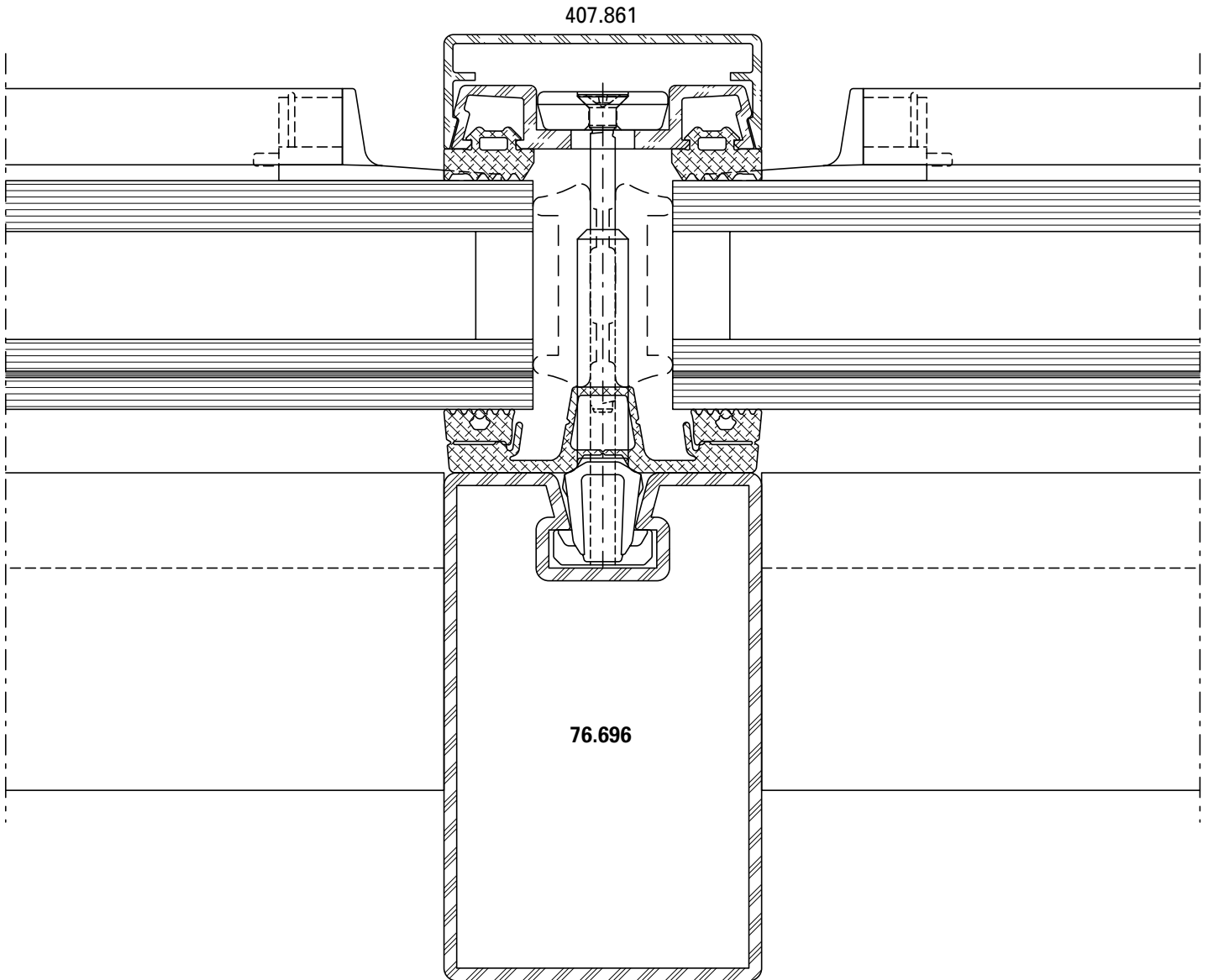

DXF

DWG

51-0301-C-004

Schnittpunkte im Massstab 1:1
Coupe de détails à l'échelle 1:1
Section details on scale 1:1

VISS Dachverglasung
Verrière VISS
VISS roof glazing

Riegeldetail
Ansichtsbreite 50 mm

Détail de la traverse
Largeur de face 50 mm

Detail of transom
Width 50 mm

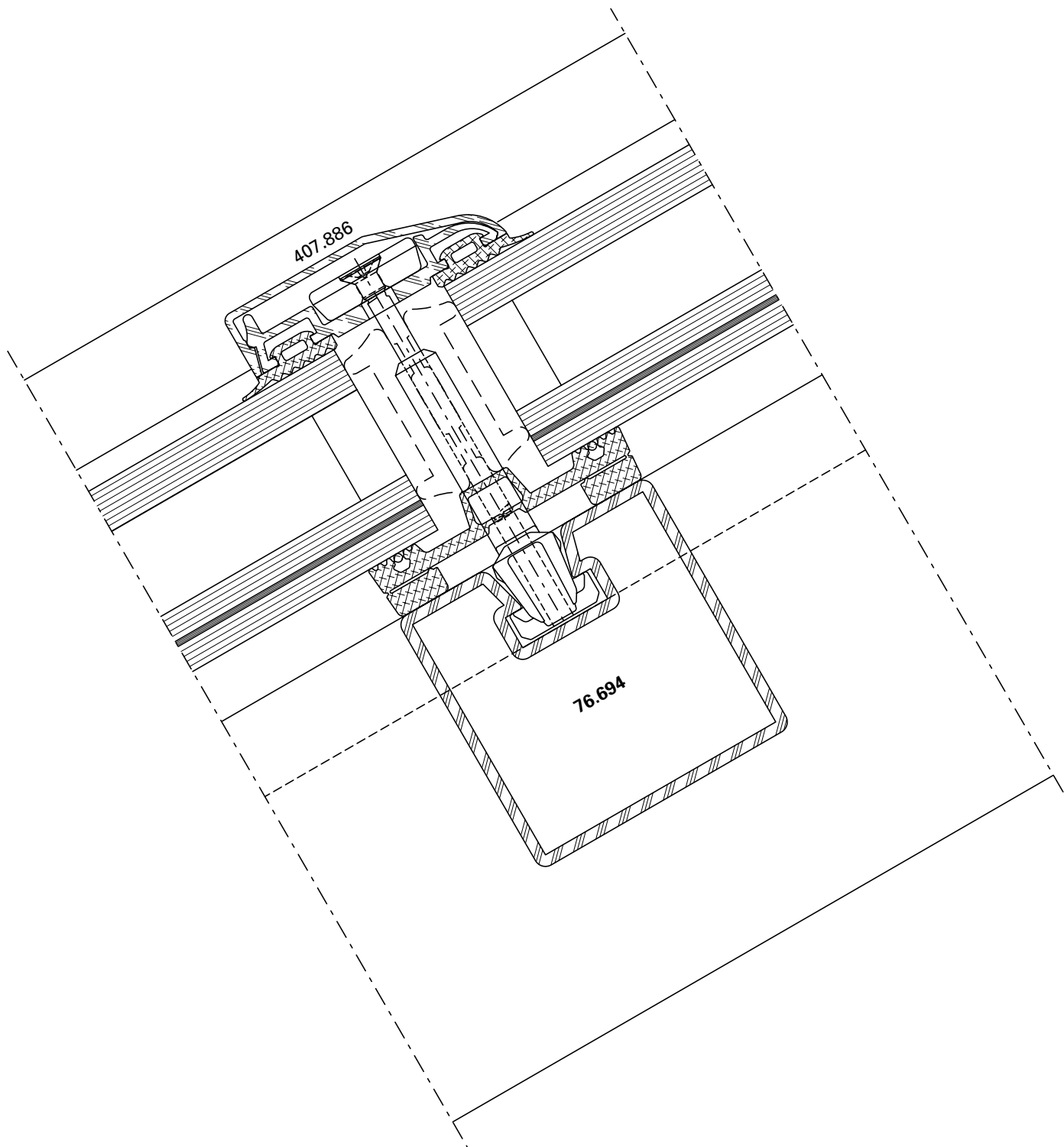

DXF

DWG

51-0301-C-005

Schnittpunkte im Massstab 1:1
Coupe de détails à l'échelle 1:1
Section details on scale 1:1

VISS Dachverglasung
Verrière VISS
VISS roof glazing

Sparrendetail HI
Ansichtsbreite 50 mm

Détail du chevron HI
Largeur de face 50 mm

Detail of rafter VHI
Width 50 mm

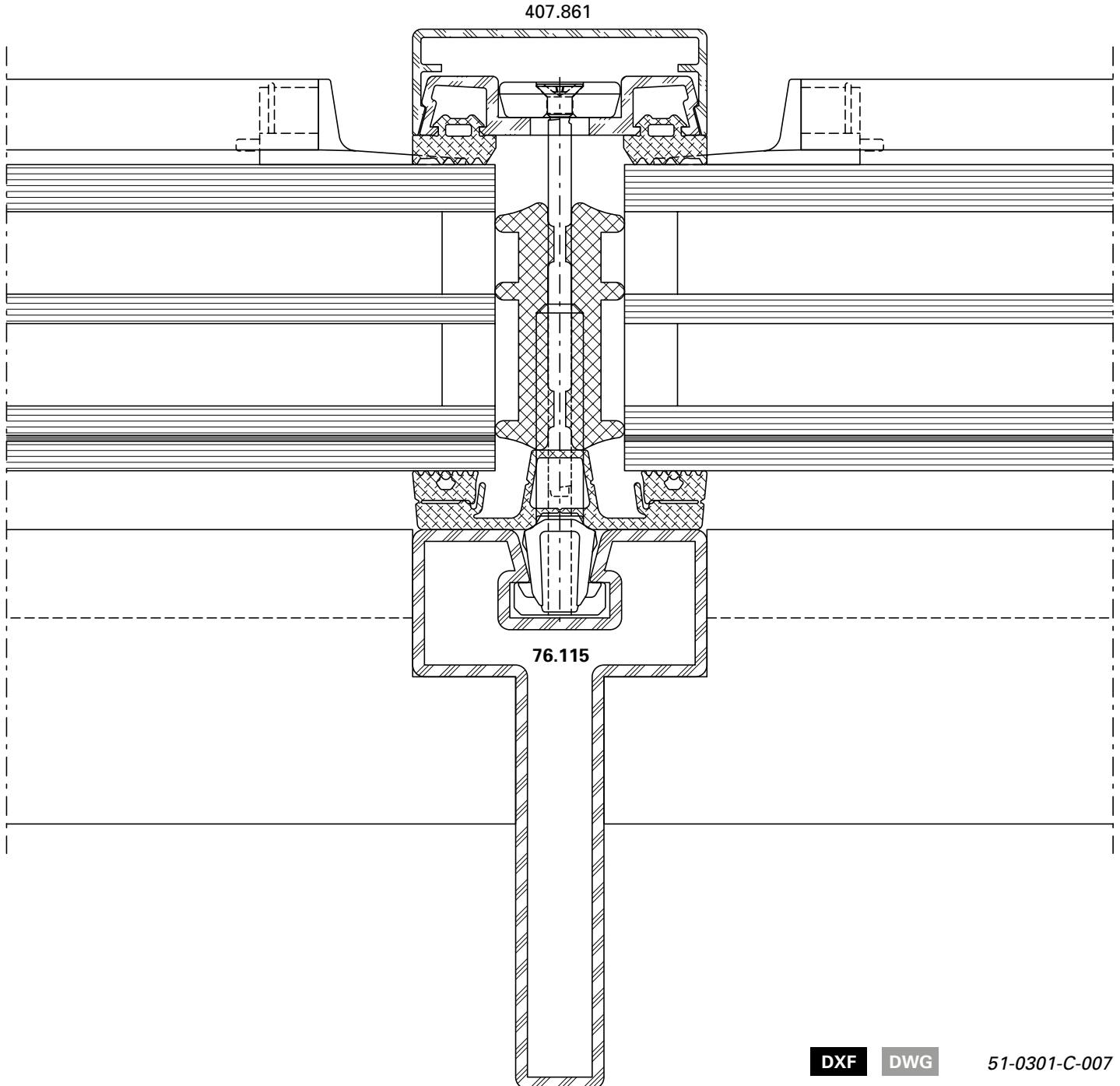

DXF

DWG

51-0301-C-007

Schnittpunkte im Massstab 1:1
Coupe de détails à l'échelle 1:1
Section details on scale 1:1

VISS Dachverglasung
Verrière VISS
VISS roof glazing

Sparrendetail HI
Ansichtsbreite 60 mm

Détail du chevron HI
Largeur de face 60 mm

Detail of rafter HI
Width 60 mm

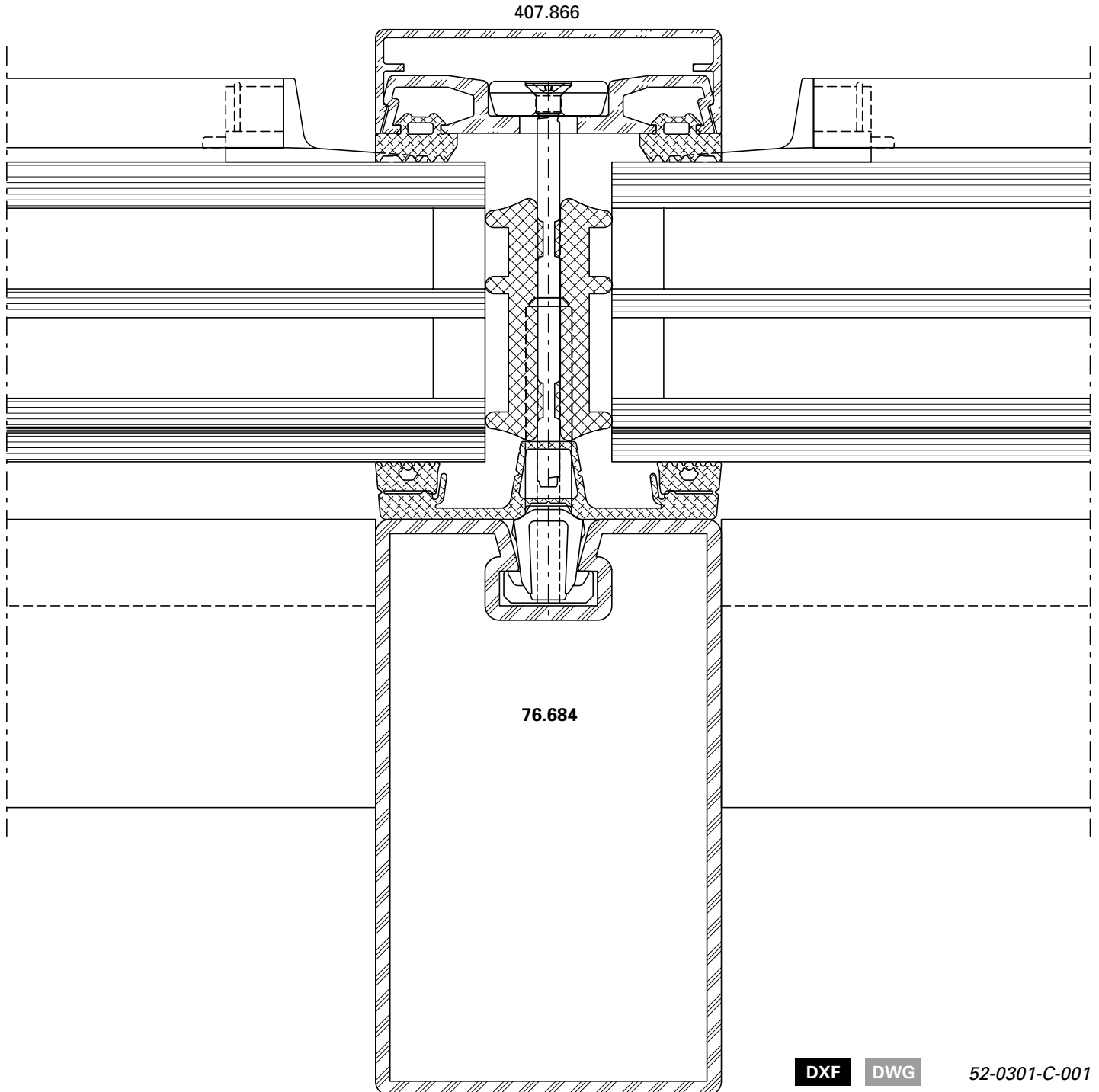

Schnittpunkte im Massstab 1:1
Coupe de détails à l'échelle 1:1
Section details on scale 1:1

VISS Dachverglasung
Verrière VISS
VISS roof glazing

Riegeldetail HI
Ansichtsbreite 60 mm

Détail de la traverse HI
Largeur de face 60 mm

Detail of transom HI
Width 60 mm

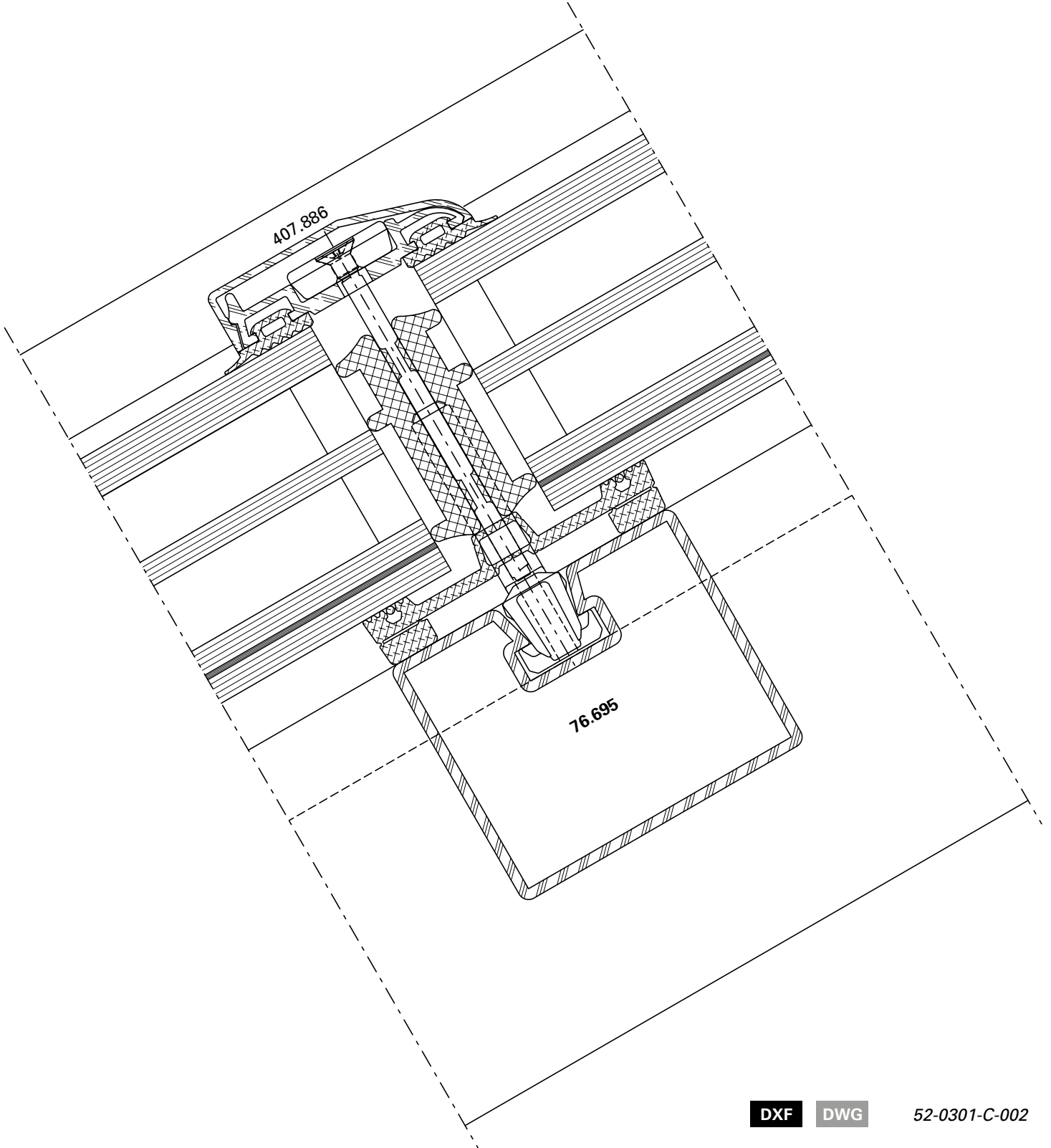

DXF

DWG

52-0301-C-002

Firstdetail 90°
Giebelverglasung 50 mm

Détail du faite 90°
Vitrage de pignon 50 mm

Ridge detail 90°
Gable glazing 50 mm

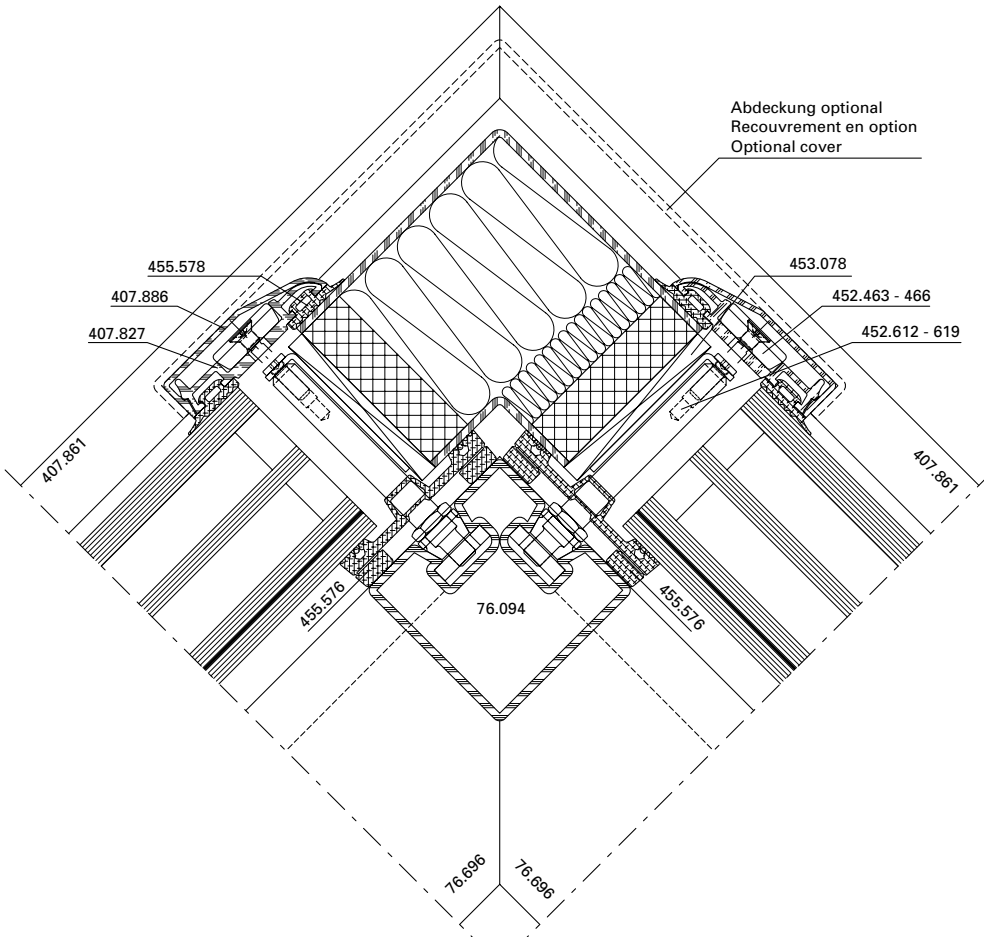

DXF

DWG

51-0301-K-001

Firstdetail variabel

Détail du faite variable

Ridge detail variable

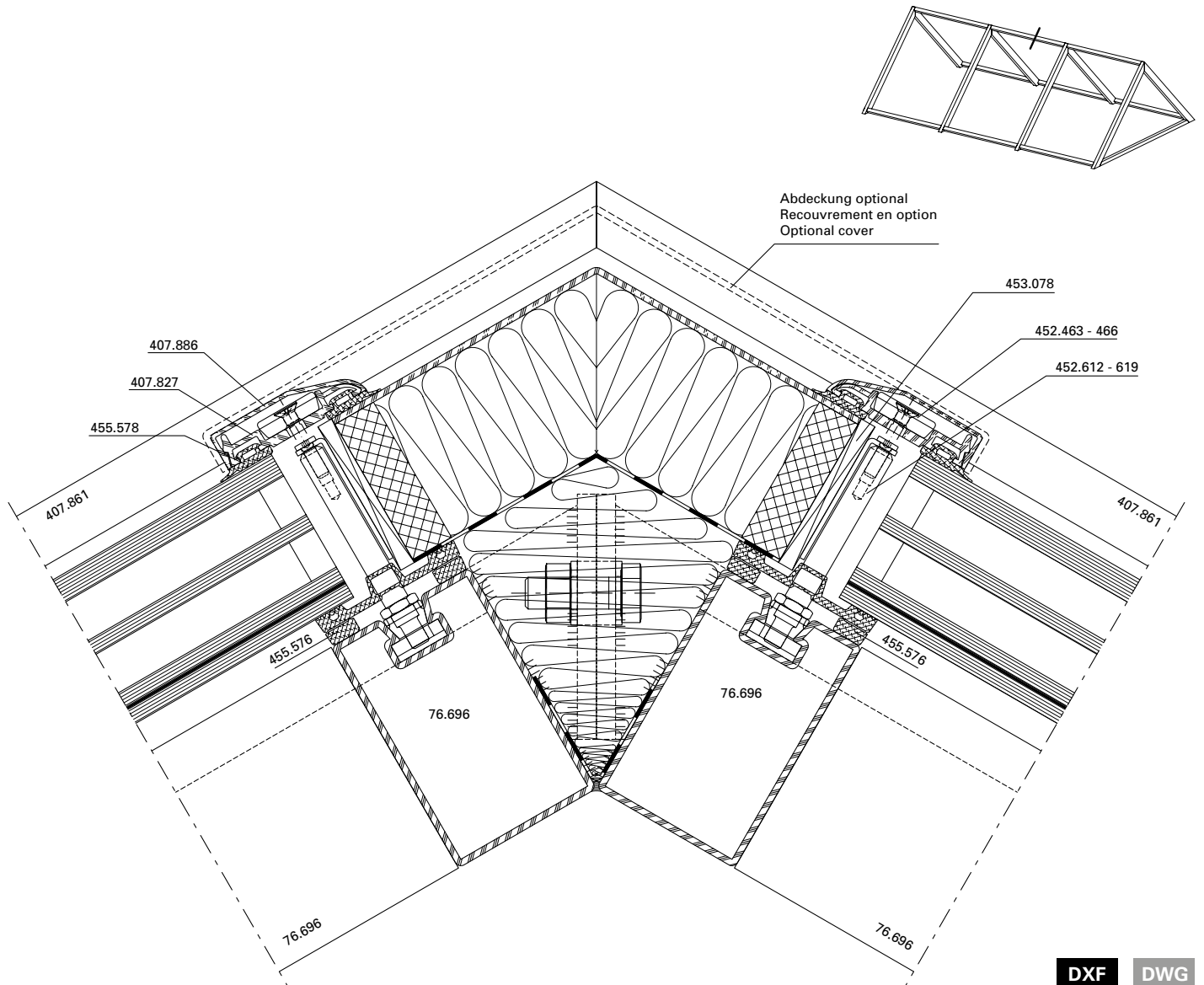

DXF DWG

51-0301-K-002

Gratdetail

Albalétriers

Angle rafter

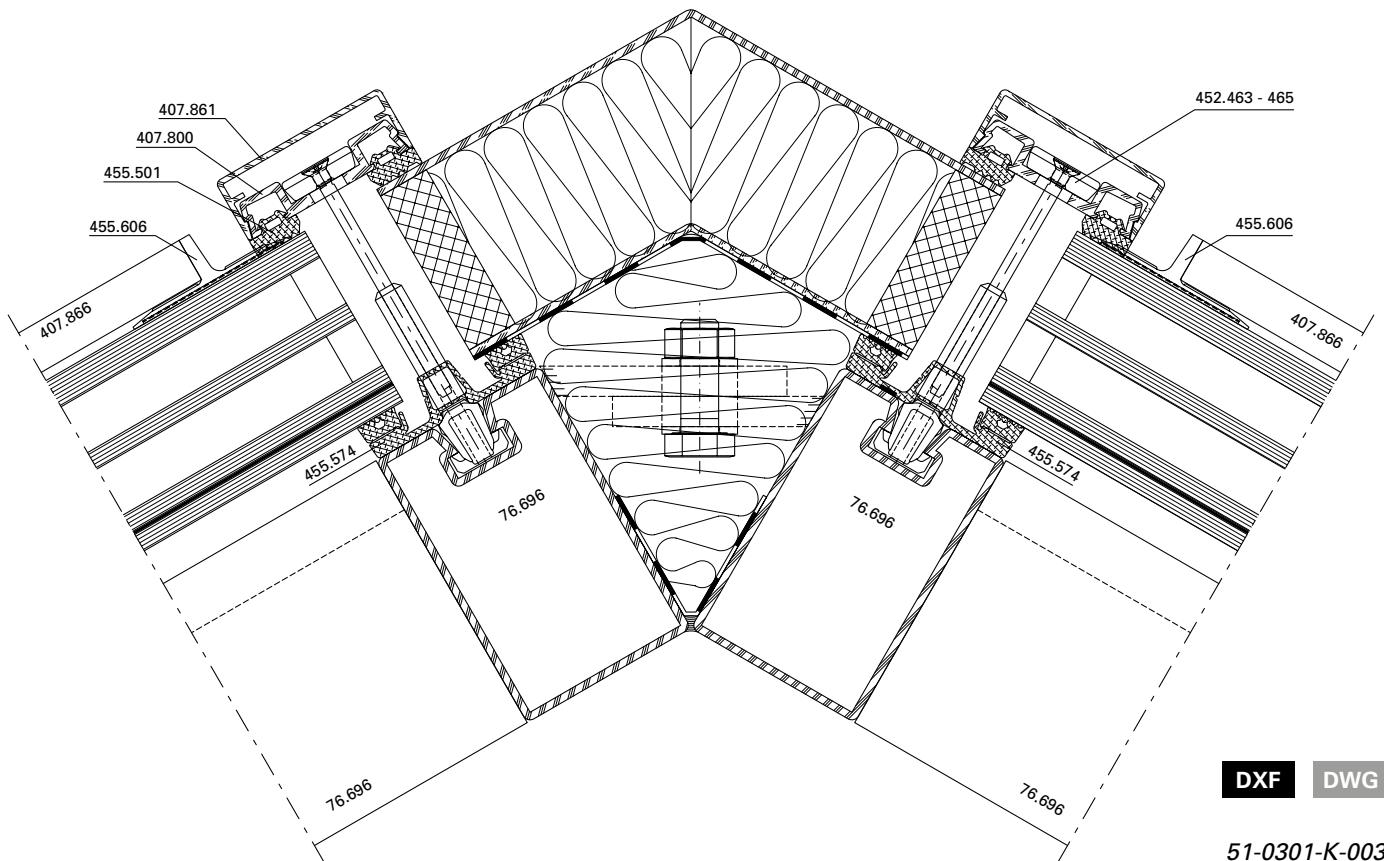
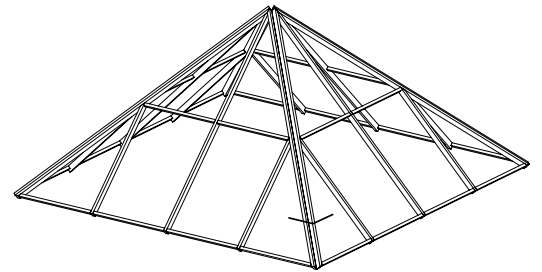
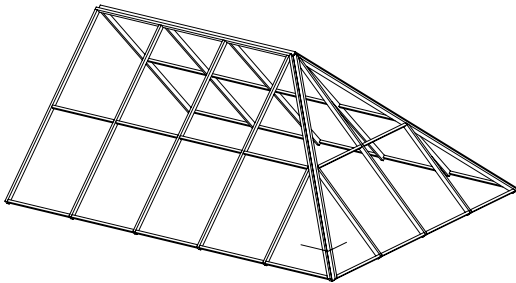

DXF DWG

51-0301-K-003

Ortgang-Detail

Détail de la rive

Verge detail

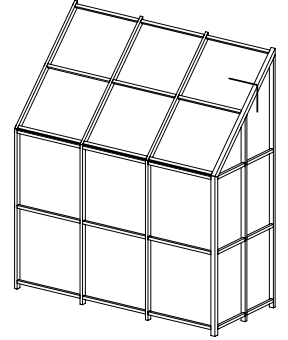
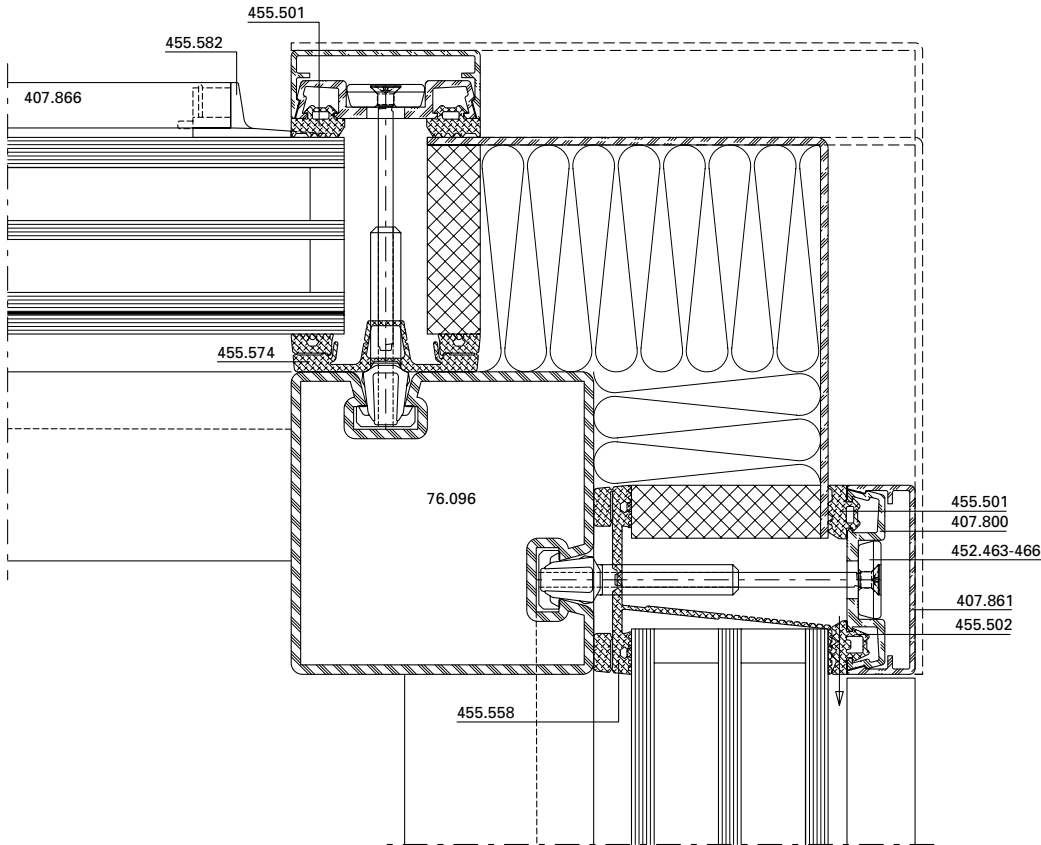

DXF DWG

51-0301-K-004

Ortgang-Detail
(Kombination mit VISS Basic)

Détail de la rive
(en combinaison avec VISS Basic)

Verge detail
(in combination with VISS Basic)

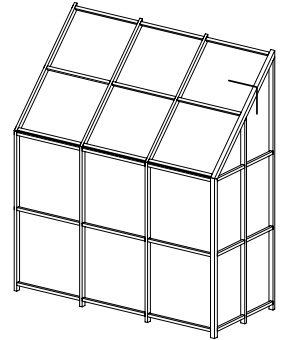
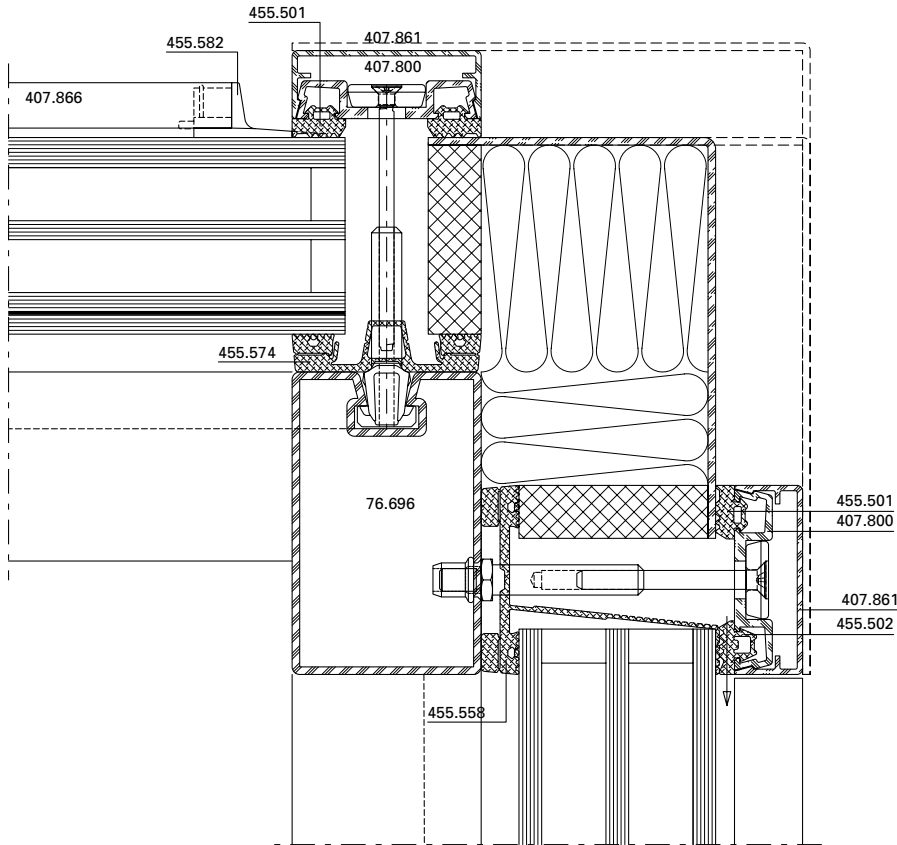

DXF **DWG**

51-0301-K-005

Knickpunktdetail mit Rinne

Détail d'angle avec gouttière

Detail of corner with gutter

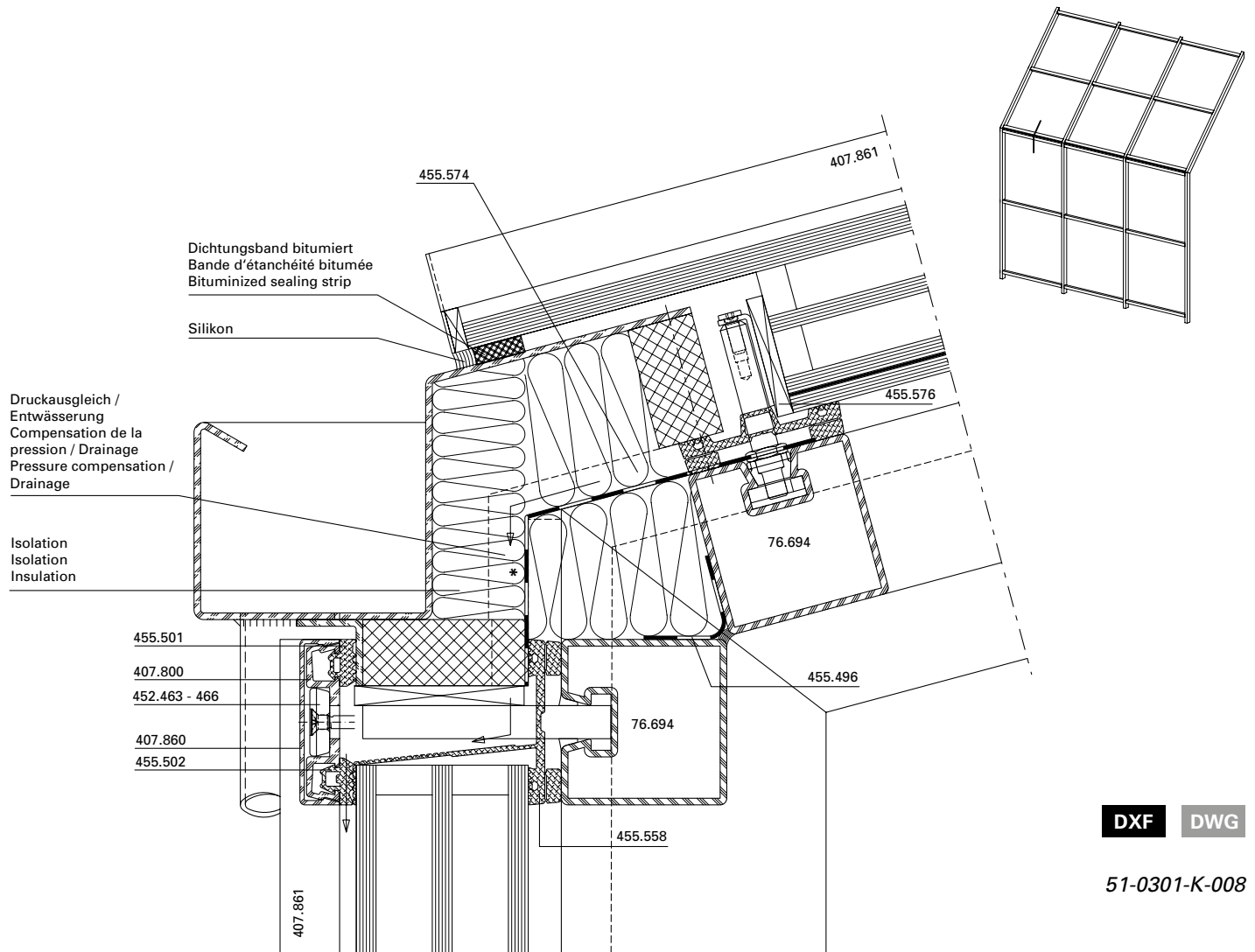

* Die Isolation muss im Bereich der Dichtung zur Sicherstellung der Entwässerung ausgeklinkt werden. Bei Konstruktionen mit Stufenglas sind die Leistungswerte nicht nachgewiesen.

* L'isolation doit être entaillée au niveau du joint pour garantir le drainage. Les valeurs de performance ne sont pas déterminées pour les constructions avec le vitrage décalé.

* The insulation must be notched in the area around the weatherstrip to ensure drainage. Performance values for constructions with stepped-edge glazing were not determined.

Traufpunkt-Detail

Détail du larmier

Detail of eave

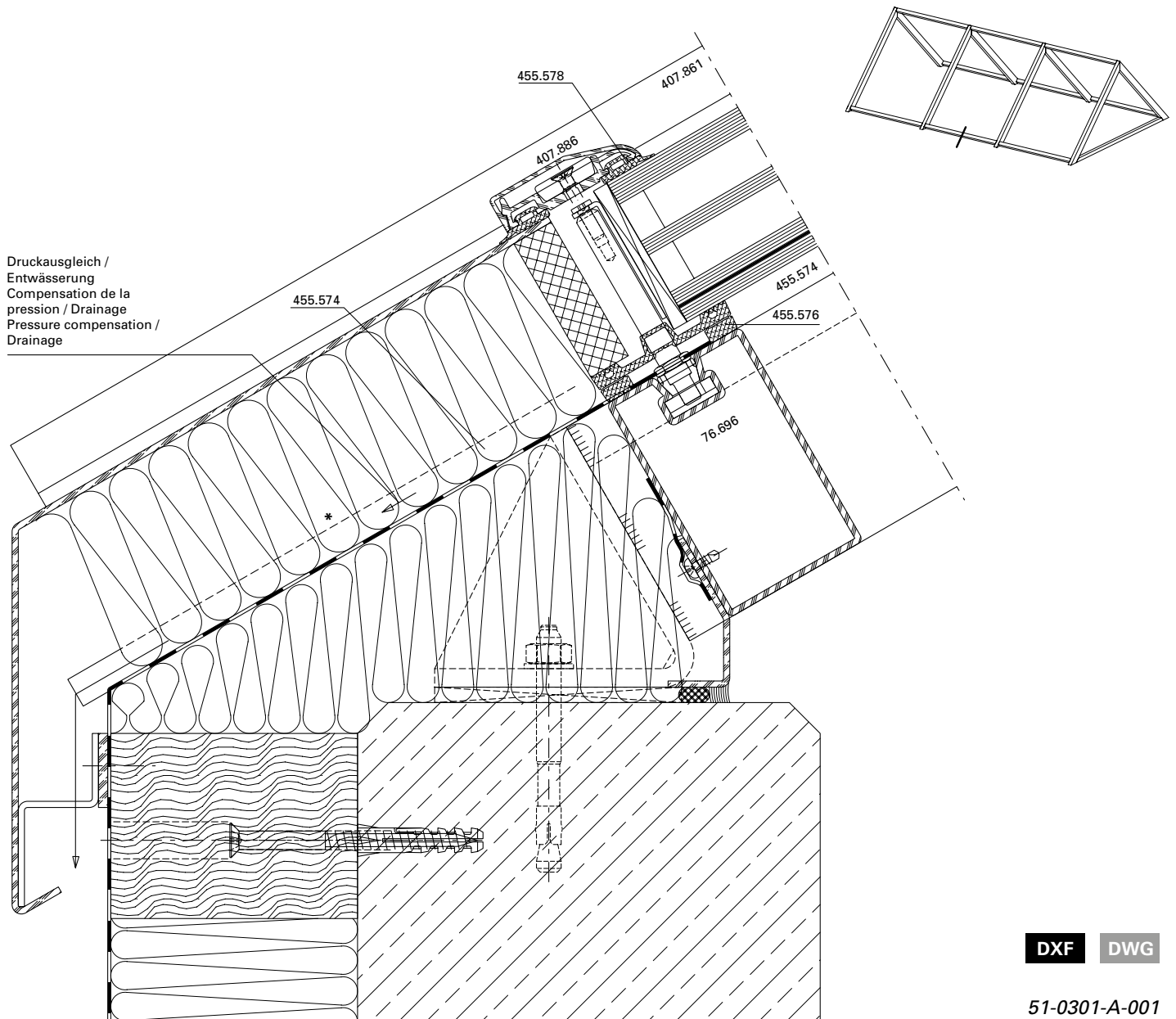

* Die Isolation muss im Bereich der Dichtung zur Sicherstellung der Entwässerung ausgeklinkt werden.

* L'isolation doit être entaillée au niveau du joint pour garantir le drainage.

* The insulation must be notched in the area around the weatherstrip to ensure drainage.

Traufpunkt-Detail

Détail du larmier

Detail of eave

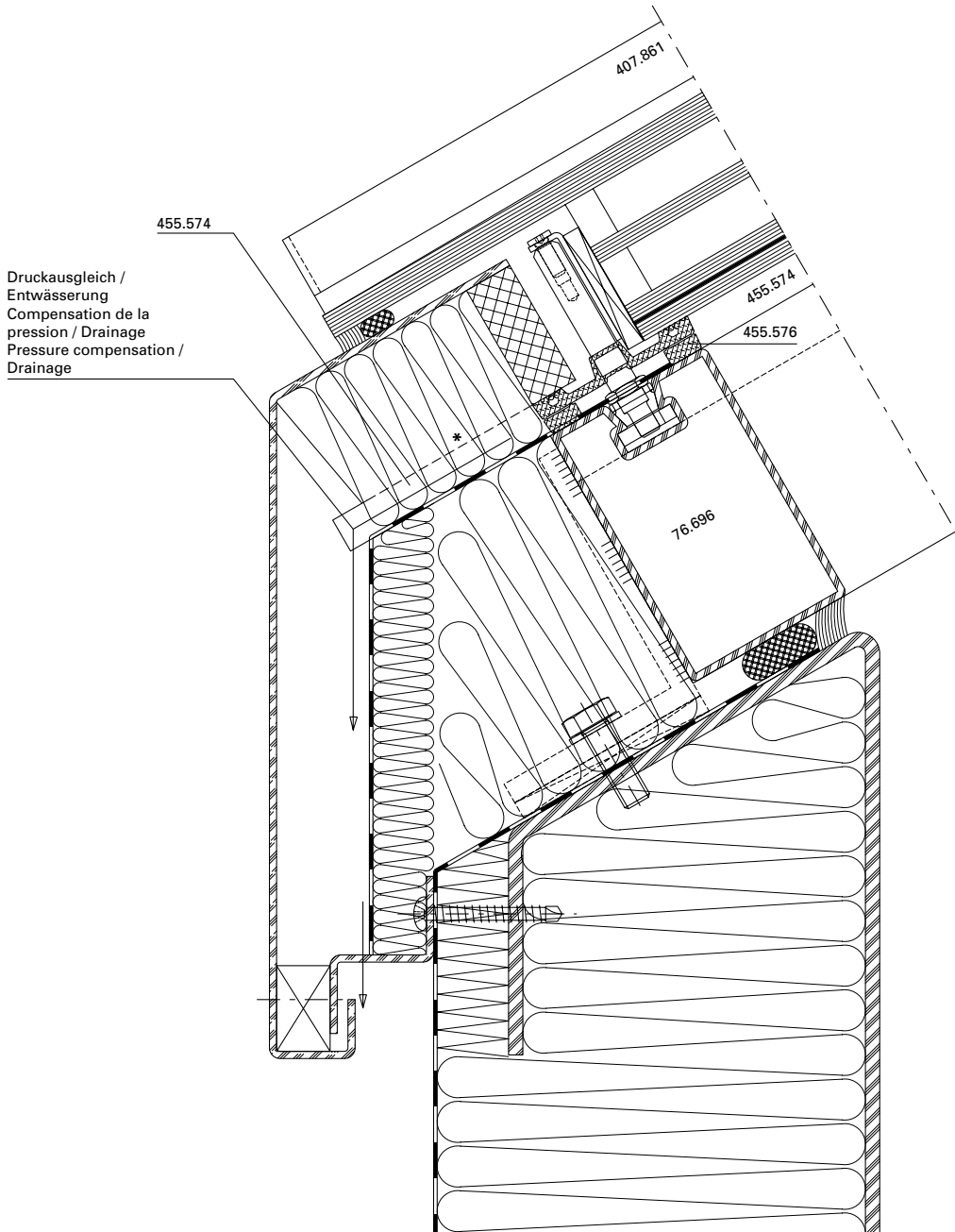

DXF DWG

51-0301-A-002

* Die Isolation muss im Bereich der Dichtung zur Sicherstellung der Entwässerung ausgeklinkt werden. Bei Konstruktionen mit Stufenglas sind die Leistungswerte nicht nachgewiesen.

* L'isolation doit être entaillée au niveau du joint pour garantir le drainage. Les valeurs de performance ne sont pas déterminées pour les constructions avec le vitrage décalé.

* The insulation must be notched in the area around the weatherstrip to ensure drainage. Performance values for constructions with stepped-edge glazing were not determined.

Traufpunkt-Detail

Détail du larmier

Detail of eave

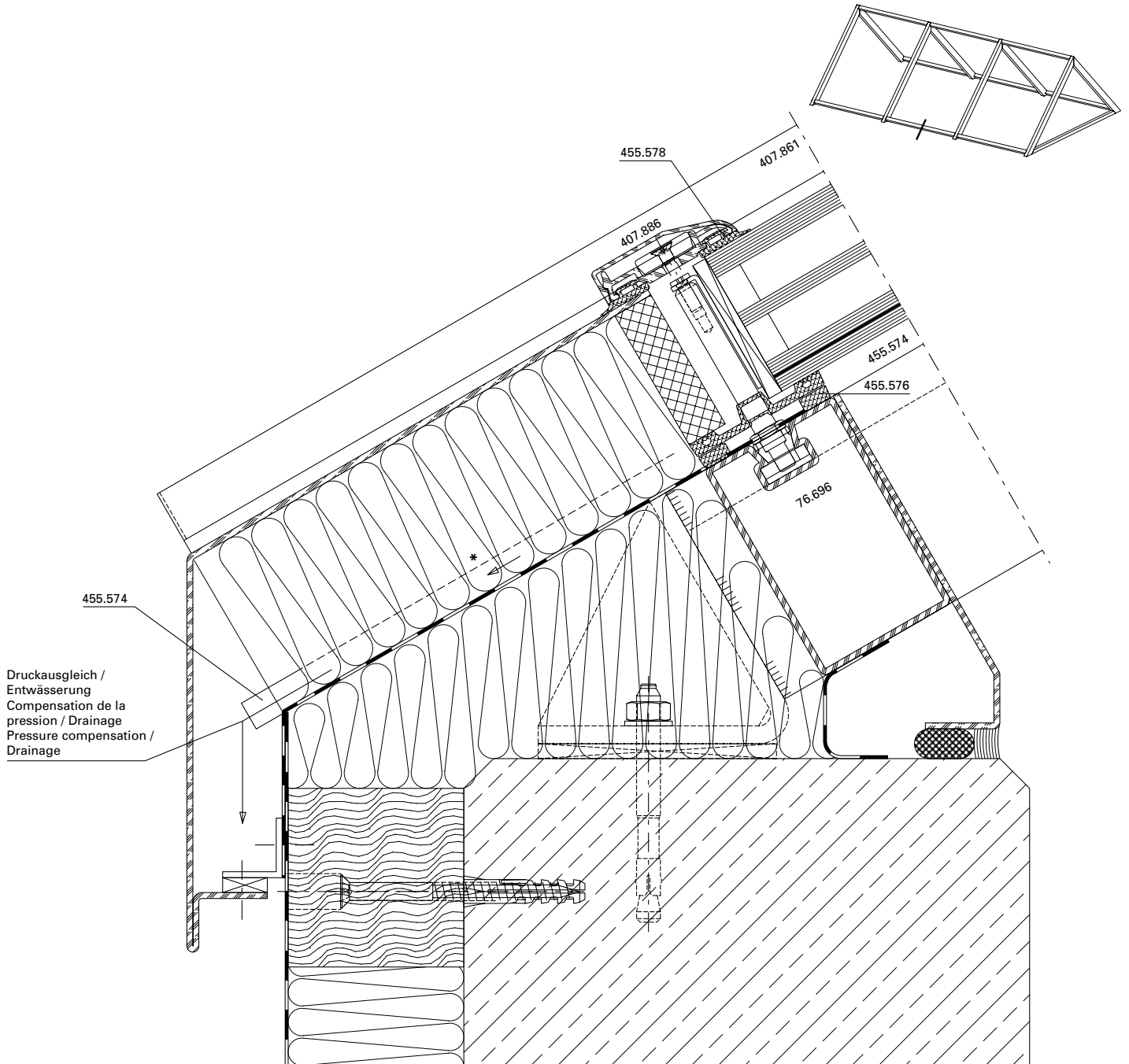

DXF DWG

51-0301-A-003

* Die Isolation muss im Bereich der Dichtung zur Sicherstellung der Entwässerung ausgeklinkt werden.

* L'isolation doit être entaillée au niveau du joint pour garantir le drainage.

* The insulation must be notched in the area around the weatherstrip to ensure drainage.

Anschlüsse am Bau im Massstab 1:2
Raccords au mur à l'échelle 1:2
Attachment to structure on scale 1:2

VISS Dachverglasung
Verrière VISS
VISS roof glazing

Wandanschlussdetail
Schrägdachverglasung

Détail raccordement au mur latéral
Vitrage inclinée

Detail of wall abutment lateral
Inclined glazing

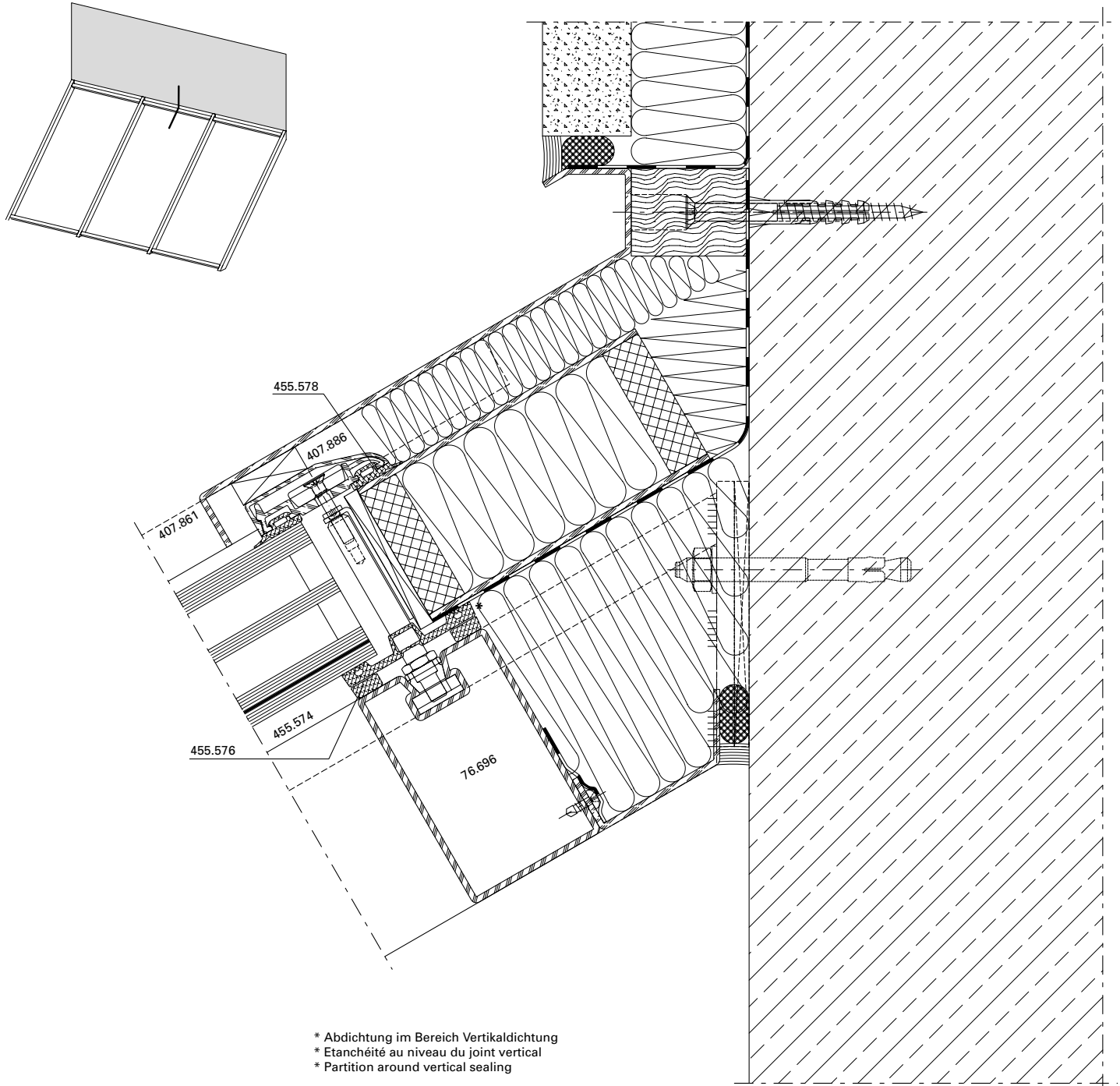

DXF DWG

51-0301-A-004

Anschlüsse am Bau im Massstab 1:2
Raccords au mur à l'échelle 1:2
Attachment to structure on scale 1:2

VISS Dachverglasung
Verrière VISS
VISS roof glazing

Wandanschluss seitlich

Raccordement au mur latéral

Wall abutment lateral

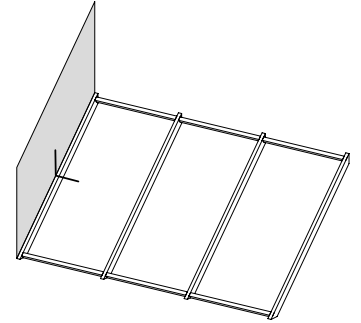
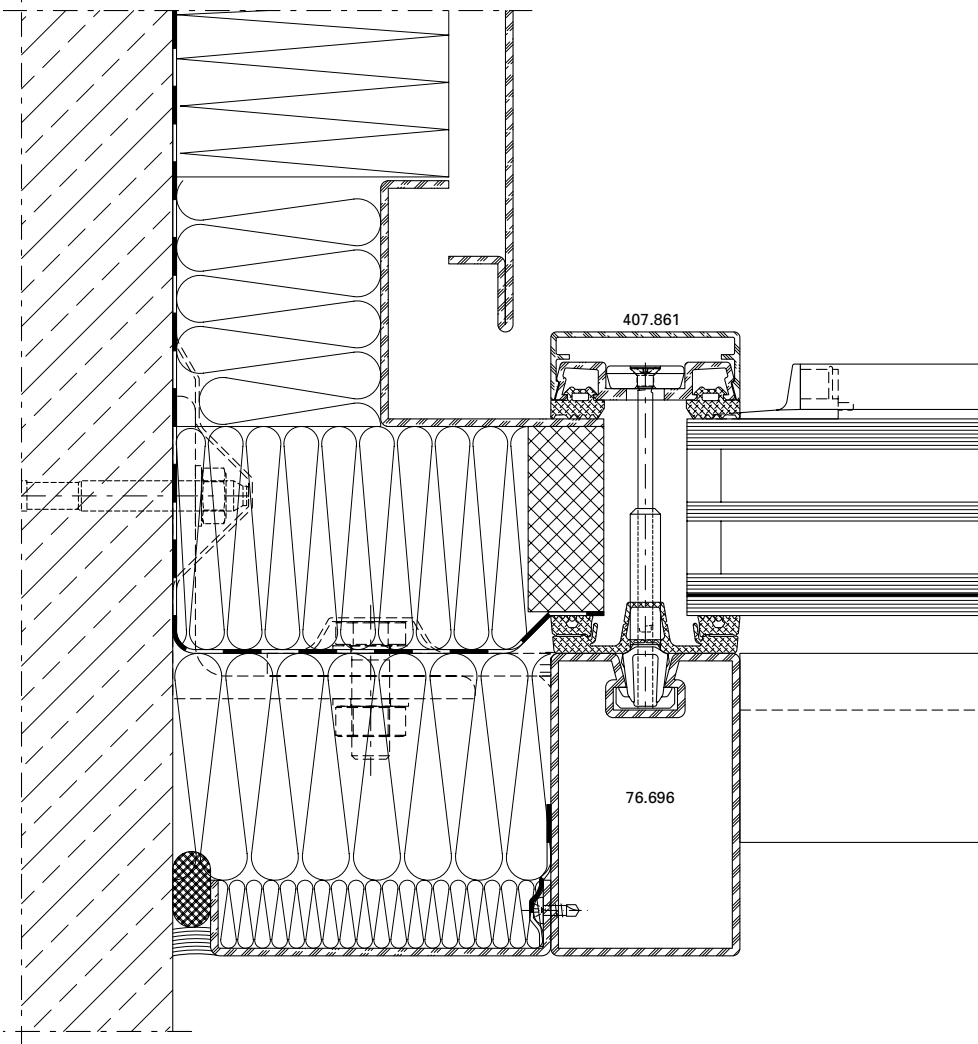

DXF DWG

51-0301-A-005

Systemhinweise

Remarques concernant les systèmes

System instructions

VISS Dachverglasung

Verrière VISS

VISS roof glazing

**VISS HI 50 mm
mit Dämmprofil**

**VISS HI 50 mm
avec gaine isolante**

**VISS HI 50 mm
with insulating core**

U_f-Werte

(nach EN ISO

10077-2:2012-02 + AC 2017-07)

Valeurs U_f

(selon EN ISO

10077-2:2012-02 + AC 2017-07)

U_f values

(according to EN ISO

10077-2:2012-02 + AC 2017-07)

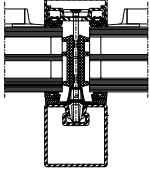
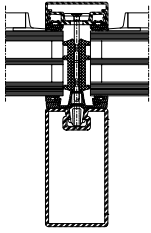
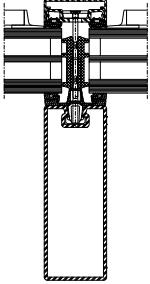
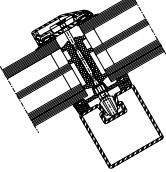
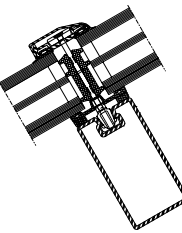
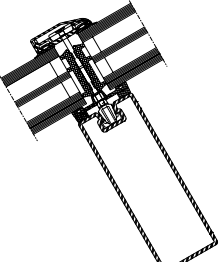
						
Glas	Pfofen 50/50	Pfofen 50/95	Pfofen 50/140	Riegel 50/50	Riegel 50/95	Riegel 50/140
Verre	Montant 50/50	Montant 50/95	Montant 50/140	Traverse 50/50	Traverse 50/95	Traverse 50/140
Glass	Mullion 50/50	Mullion 50/95	Mullion 50/140	Transom 50/50	Transom 50/95	Transom 50/140
35 mm	0,86 W/m²K	0,87 W/m²K	0,88 W/m²K	0,87 W/m²K	0,88 W/m²K	0,88 W/m²K
40 mm	0,77 W/m²K	0,78 W/m²K	0,79 W/m²K	0,78 W/m²K	0,79 W/m²K	0,79 W/m²K
50 mm	0,65 W/m²K	0,66 W/m²K	0,65 W/m²K	0,65 W/m²K	0,66 W/m²K	0,66 W/m²K
60 mm	0,56 W/m²K	0,57 W/m²K	0,57 W/m²K	0,56 W/m²K	0,57 W/m²K	0,57 W/m²K
70 mm	0,53 W/m²K	0,53 W/m²K	0,53 W/m²K	0,53 W/m²K	0,53 W/m²K	0,53 W/m²K

**Der Einfluss der Schrauben-
befestigung in Höhe von 0.14 W/m²K
ist berücksichtigt.**

**L'influence de la fixation à vis de
0.14 W/m²K est prise en compte.**

**The 0.14 W/m²K influence of the
screw fixing is taken into account.**

Systemhinweise

Remarques concernant les systèmes

System instructions

VISS Dachverglasung

Verrière VISS

VISS roof glazing

**VISS HI 60 mm
mit Dämmprofil**

**VISS HI 60 mm
avec gaine isolante**

**VISS HI 60 mm
with insulating core**

U_f-Werte

(nach EN ISO

10077-2:2012-02 + AC 2017-07)

Valeurs U_f

(selon EN ISO

10077-2:2012-02 + AC 2017-07)

U_f values

(according to EN ISO

10077-2:2012-02 + AC 2017-07)

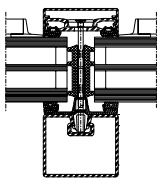
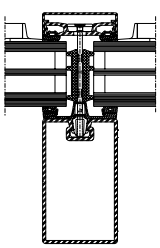
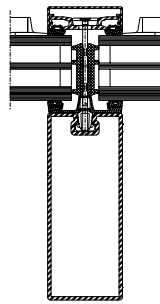
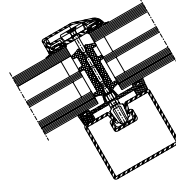
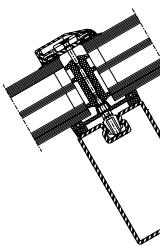
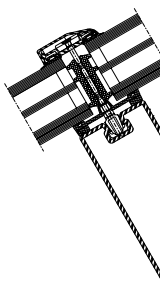
						
Glas Verre Glass	Pfosten 60/50 Montant 60/50 Mullion 60/50	Pfosten 60/100 Montant 60/100 Mullion 60/100	Pfosten 60/150 Montant 60/150 Mullion 60/150	Riegel 60/50 Traverse 60/50 Transom 60/50	Riegel 60/100 Traverse 60/100 Transom 60/100	Riegel 60/150 Traverse 60/150 Transom 60/150
35 mm	0,84 W/m²K	0,85 W/m²K	0,85 W/m²K	0,85 W/m²K	0,86 W/m²K	0,87 W/m²K
40 mm	0,75 W/m²K	0,76 W/m²K	0,77 W/m²K	0,76 W/m²K	0,77 W/m²K	0,77 W/m²K
50 mm	0,63 W/m²K	0,64 W/m²K	0,64 W/m²K	0,64 W/m²K	0,65 W/m²K	0,65 W/m²K
60 mm	0,56 W/m²K	0,56 W/m²K	0,56 W/m²K	0,56 W/m²K	0,56 W/m²K	0,57 W/m²K
70 mm	0,50 W/m²K	0,50 W/m²K	0,51 W/m²K	0,50 W/m²K	0,50 W/m²K	0,50 W/m²K

	76.140	76.141	76.142	76.140	76.141	76.142
Glas Verre Glass	Pfosten 60/180 Montant 60/180 Mullion 60/180	Pfosten 60/220 Montant 60/220 Mullion 60/220	Pfosten 60/280 Montant 60/280 Mullion 60/280	Riegel 60/180 Traverse 60/180 Transom 60/180	Riegel 60/220 Traverse 60/220 Transom 60/220	Riegel 60/280 Traverse 60/280 Transom 60/280
60 mm	0,56 W/m²K	0,57 W/m²K	0,57 W/m²K	0,57 W/m²K	0,57 W/m²K	0,57 W/m²K
70 mm	0,51 W/m²K	0,51 W/m²K	0,51 W/m²K	0,51 W/m²K	0,51 W/m²K	0,51 W/m²K

**Der Einfluss der Schrauben-
befestigung in Höhe von 0.14 W/m²K
ist berücksichtigt.**

**L'influence de la fixation à vis de
0.14 W/m²K est prise en compte.**

**The 0.14 W/m²K influence of the
screw fixing is taken into account.**

Systemhinweise**Remarques concernant les systèmes****System instructions**

VISS Dachverglasung

Verrière VISS

VISS roof glazing

VISS 50 mm

VISS 50 mm

VISS 50 mm

U_f-Werte

(nach EN ISO

10077-2:2012-02 + AC 2017-07)

Valeurs U_f

(selon EN ISO

10077-2:2012-02 + AC 2017-07)

U_f values

(according to EN ISO

10077-2:2012-02 + AC 2017-07)

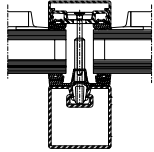
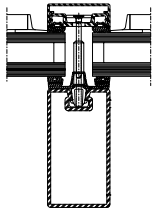
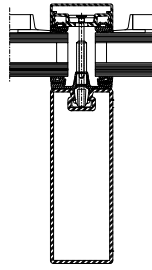
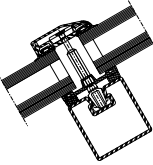
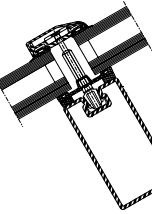
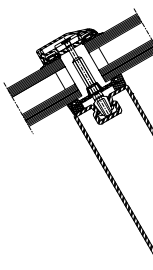
						
Glas Verre Glass	Pfosten 50/50 Montant 50/50 Mullion 50/50	Pfosten 50/95 Montant 50/95 Mullion 50/95	Pfosten 50/140 Montant 50/140 Mullion 50/140	Riegel 50/50 Traverse 50/50 Transom 50/50	Riegel 50/95 Traverse 50/95 Transom 50/95	Riegel 50/140 Traverse 50/140 Transom 50/140
20 mm	1,7 W/m ² K	1,7 W/m ² K	1,7 W/m ² K	1,5 W/m ² K	1,5 W/m ² K	1,5 W/m ² K
30 mm	1,5 W/m ² K	1,5 W/m ² K	1,5 W/m ² K	1,3 W/m ² K	1,3 W/m ² K	1,4 W/m ² K
40 mm	1,4 W/m ² K	1,4 W/m ² K	1,4 W/m ² K	1,2 W/m ² K	1,3 W/m ² K	1,3 W/m ² K
50 mm	1,3 W/m ² K	1,3 W/m ² K	1,4 W/m ² K	1,2 W/m ² K	1,2 W/m ² K	1,2 W/m ² K
60 mm	1,3 W/m ² K	1,3 W/m ² K	1,2 W/m ² K	1,1 W/m ² K	1,2 W/m ² K	1,2 W/m ² K
70 mm	1,2 W/m ² K	1,3 W/m ² K	1,3 W/m ² K	1,1 W/m ² K	1,1 W/m ² K	1,1 W/m ² K

Der Einfluss der Schraubenbefestigung in Höhe von 0.14 W/m²K ist berücksichtigt.

L'influence de la fixation à vis de 0.14 W/m²K est prise en compte.

The 0.14 W/m²K influence of the screw fixing is taken into account.

Systemhinweise

Remarques concernant les systèmes

System instructions

VISS Dachverglasung

Verrière VISS

VISS roof glazing

VISS 60 mm

VISS 60 mm

VISS 60 mm

U_f-Werte

(nach EN ISO

10077-2:2012-02 + AC 2017-07)

Valeurs U_f

(selon EN ISO





10077-2:2012-02 + AC 2017-07)

U_f values

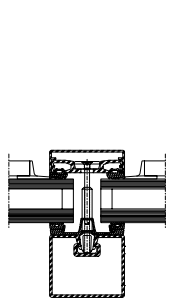
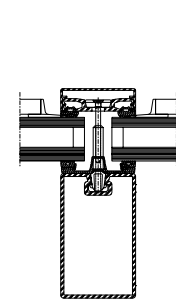
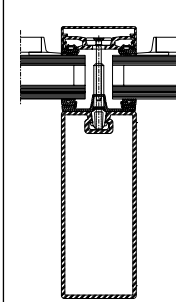
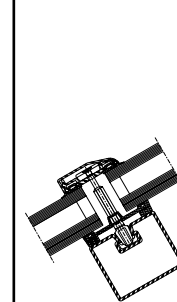
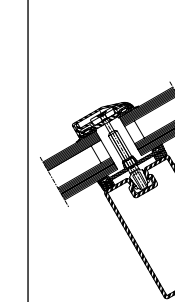
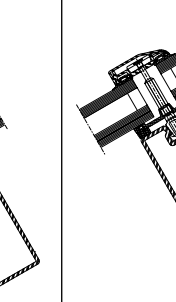
(according to EN ISO

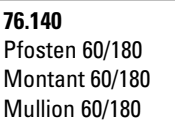
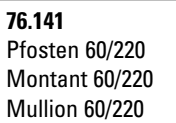
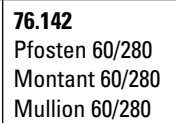
10077-2:2012-02 + AC 2017-07)

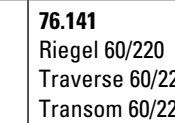
						
Glas Verre Glass	Pfosten 60/50 Montant 60/50 Mullion 60/50	Pfosten 60/100 Montant 60/100 Mullion 60/100	Pfosten 60/150 Montant 60/150 Mullion 60/150	Riegel 60/50 Traverse 60/50 Transom 60/50	Riegel 60/100 Traverse 60/100 Transom 60/100	Riegel 60/150 Traverse 60/150 Transom 60/150
20 mm	1,6 W/m ² K	1,6 W/m ² K	1,6 W/m ² K	1,4 W/m ² K	1,4 W/m ² K	1,5 W/m ² K
30 mm	1,4 W/m ² K	1,4 W/m ² K	1,4 W/m ² K	1,3 W/m ² K	1,3 W/m ² K	1,3 W/m ² K
40 mm	1,3 W/m ² K	1,3 W/m ² K	1,3 W/m ² K	1,1 W/m ² K	1,1 W/m ² K	1,2 W/m ² K
50 mm	1,2 W/m ² K	1,2 W/m ² K	1,2 W/m ² K	1,1 W/m ² K	1,1 W/m ² K	1,1 W/m ² K
60 mm	1,1 W/m ² K	1,1 W/m ² K	1,1 W/m ² K	1,0 W/m ² K	1,0 W/m ² K	1,0 W/m ² K
70 mm	1,1 W/m ² K	1,1 W/m ² K	1,1 W/m ² K	0,96 W/m ² K	0,98 W/m ² K	0,99 W/m ² K

						
Glas Verre Glass	76.140 Pfosten 60/180 Montant 60/180 Mullion 60/180	76.141 Pfosten 60/220 Montant 60/220 Mullion 60/220	76.142 Pfosten 60/280 Montant 60/280 Mullion 60/280	76.140 Riegel 60/180 Traverse 60/180 Transom 60/180	76.141 Riegel 60/220 Traverse 60/220 Transom 60/220	76.142 Riegel 60/280 Traverse 60/280 Transom 60/280
20 mm	1,7 W/m ² K	1,6 W/m ² K	1,7 W/m ² K	1,5 W/m ² K	1,5 W/m ² K	1,5 W/m ² K
30 mm	1,4 W/m ² K	1,4 W/m ² K	1,4 W/m ² K	1,3 W/m ² K	1,3 W/m ² K	1,3 W/m ² K
40 mm	1,3 W/m ² K	1,3 W/m ² K	1,3 W/m ² K	1,2 W/m ² K	1,2 W/m ² K	1,2 W/m ² K
50 mm	1,2 W/m ² K	1,2 W/m ² K	1,2 W/m ² K	1,1 W/m ² K	1,1 W/m ² K	1,1 W/m ² K
60 mm	1,1 W/m ² K	1,1 W/m ² K	1,2 W/m ² K	1,0 W/m ² K	1,0 W/m ² K	1,0 W/m ² K
70 mm	1,1 W/m ² K	1,1 W/m ² K	1,1 W/m ² K	0,99 W/m ² K	0,99 W/m ² K	0,99 W/m ² K

Der Einfluss der Schraubenbefestigung in Höhe von 0.14 W/m²K ist berücksichtigt.

L'influence de la fixation à vis de 0.14 W/m²K est prise en compte.

The 0.14 W/m²K influence of the screw fixing is taken into account.

