

Janisol 2 EI30 Schiebetüren

Automatische Brandschutz-Schiebetüren aus Stahl

Portes coulissantes Janisol 2 EI30

Portes coulissantes coupe-feu automatiques en acier

Janisol 2 EI30 sliding doors

Automatically fire resistant sliding doors in steel

Systemübersicht

Merkmale
Zulassungen
Typenübersicht

Sommaire du système

Caractéristiques
Homologations
Sommaire des types

Summary of system

Characteristics
Authorisations
Summary of types

2

Profilsortiment

Assortiment de profilé

Range of profiles

9

Beispiele

Schnittpunkte
Konstruktionsdetails
Anschlüsse am Bau

Exemples

Coupes de détails
Détails de construction
Raccords au mur

Examples

Section details
Construction details
Attachment to structure

11

Alle Ausführungen dieser Dokumentation haben wir sorgfältig und nach bestem Wissen zusammengestellt. Wir können aber keine Verantwortung für die Benutzung der vermittelten Vorschläge und Daten übernehmen. Wir behalten uns technische Änderungen ohne Vorankündigung vor.
Aktuelle Version auf www.jansen.com

Nous avons apporté le plus grand soin à l'élaboration de cette documentation. Cependant, nous déclinons toute responsabilité pour l'utilisation faite de nos propositions et de nos données.
Nous nous réservons le droit de procéder à des modifications techniques sans préavis.
Version actuelle sur www.jansen.com

All the information contained in this documentation is given to the best of our knowledge and ability. However, we decline all responsibility for the use made of these suggestions and data.
We reserve the right to effect technical modifications without prior warning.
Current version available at www.jansen.com

Systembeschreibung

Description du système

System description

Extrem schlankes Profil mit höchsten Sicherheitsfunktionen.

Die Janisol 2 EI30 Brandschutzschiebetüre wird in hoch frequentierten, barrierefreien Gebäuden wie Einkaufszentren, Stadien oder Verwaltungsgebäuden eingesetzt. Das automatisch öffnende Türsystem ist mit oder ohne integrierter Fluchttürfunktion sowie einer grossen Auswahl an Antriebsmotoren, Glaseinsätzen und Paneelen erfolgreich in der Feuerwiderstandsklasse EI30 nach EN 1634 geprüft worden. Die maximalen lichten Durchgangsbreiten/-höhen betragen 1400 × 2500 mm für einflügelige bzw. 2800 × 2500 mm für zweiflügelige Konstruktionen. Ein wichtiger Vorteil ist die einfache und sichere Verarbeitung. Dank dem neuen, mit Keramikmasse gefüllten, Spezialprofil für Blend- und Flügelrahmen sind weder aufwändige Blechkantarbeiten noch der Einbau von zusätzlichen Brandschutzplatten im Labyrinthbereich notwendig. Auch kann auf eine Bodenführung im Durchgangsbereich verzichtet werden.

Profilé extrêmement fin aux fonctions de sécurité très élevées.

La porte coulissante coupe-feu Janisol 2 EI30 est utilisée dans les bâtiments sans barrière très fréquentés tels que les centres commerciaux, les stades ou les bâtiments administratifs. Le système de porte à ouverture automatique avec ou sans fonction porte de secours intégrée ainsi qu'avec un grand choix de moteurs et de panneaux, a passé avec succès le contrôle dans la classe de résistance au feu EI30 selon EN 1634. Les tailles maximales de vantaux sont de 1400 × 2500 mm pour les constructions à un vantail et de 2800 × 2500 mm pour celles à deux vantaux. L'usage simple et sûr est un autre avantage important. Grâce au nouveau profilé spécial rempli de masse de céramique pour les cadres dormants et de vantaux, aucun travail de bordage de tôle n'est nécessaire, aucune plaque coupe-feu supplémentaire doit être montée. Il est également possible de se passer du rail dans le sol dans la zone de passage.

Brandschutzschiebetüre EI30

Porte coulissante coupe-feu EI30

Fire-resistant sliding door EI30

Extremely narrow profile with maximum safety features.

The Janisol 2 EI30 fire-resistant sliding door is used in busy buildings requiring easy access, such as shopping centres, stadia or office buildings. The automatic door system has been successfully tested to fire-resistance class EI30 in accordance with EN 1634 with and without integrated emergency exit function, as well as with a wide variety of motors, glass inserts and panels. The maximum vent dimensions are 1400 × 2500 mm for single-vent constructions, and 2800 × 2500 mm for double-vent constructions. A key benefit is simple and reliable fabrication. Thanks to the new special profile filled with ceramic compound for the outer and vent frames, no complex work is necessary for the sheet edge, and no additional fire-resistant panels are required. There is also no need for a floor guide in the entrance area.



Elementgrößen

Schiebetüre

- 1-flügelig
Lichte Durchgangsbreite/-höhe
max. 1400 × 2500 mm
- 2-flügelig
Lichte Durchgangsbreite/-höhe
max. 2800 × 2500 mm

Schiebetüre mit Break-Out/Break-In Fluchttürfunktion

- 1-flügelig
Lichte Durchgangsbreite/-höhe
max. 1250 × 2500 mm
- 2-flügelig
Lichte Durchgangsbreite/-höhe
max. 2400 × 2500 mm

Elementgrößen

siehe Typenübersicht

Gewicht Flügel

max. 170 kg Break-Out/Break-In Flügel
max. 225 kg Türflügel inkl. Joch

Zugelassene Füllelemente

- Fireswiss Foam
- Pyrostop
- Contraflam
- Pyrobel
- Fire Mono
- Pyranova
- Paneele

Einbau Füllelemente

Trockenverglasung mit EPDM-Dichtungen oder Nassverglasung mit Dichtungsband (schwer entflammbar)

Zugelassene Türantriebe

- Dorma
- GEZE
- Gilgen Door Systems
- Tormax
- Record

Die Inbetriebnahme der Schiebetüren erfolgt durch den Antriebshersteller.

Taille des éléments

Porte coulissante

- 1 vantail
Largeur/hauteur de passage intérieur
max. 1400 × 2500 mm
- 2 vantaux
Largeur/hauteur de passage intérieur
max. 2800 × 2500 mm

Porte coulissante avec fonction porte de secours Break-Out/Break-In

- 1 vantail
Largeur/hauteur de passage intérieur
max. 1250 × 2500 mm
- 2 vantaux
Largeur/hauteur de passage intérieur
max. 2400 × 2500 mm

Taille des éléments

voir le sommaire des types

Poids vantail

max. 170 kg vantail Break-Out/Break-In
max. 225 kg vantail de porte avec cadre dormant

Éléments de remplissage autorisés

- Fireswiss Foam
- Pyrostop
- Contraflam
- Pyrobel
- Fire Mono
- Pyranova
- Panneaux

Montage d'éléments de remplissage

Vitrage à sec avec joints EPDM ou vitrage à silicone avec bande d'étanchéité (difficilement combustible)

Entraînements de porte autorisés

- Dorma
- GEZE
- Gilgen Door Systems
- Tormax
- Record

La mise en service de l'installation coulissante ne doit être réalisée que par les fournisseurs d'entraînements.

Unit sizes

Sliding door

- Single-vent
Clear opening width/height:
max. 1400 × 2500 mm
- Double-vent
Clear opening width/height:
max. 2800 × 2500 mm

Sliding doors with Break-Out/Break-In emergency exit function

- Single-vent
Clear opening width/height:
max. 1250 × 2500 mm
- Double-vent
Clear opening width/height:
max. 2400 × 2500 mm

Unit sizes

see summary of types

Vent weight

Max. 170 kg Break-Out/Break-In vent
Max. 225 kg vent including yoke

Approved infill units

- Fireswiss Foam
- Pyrostop
- Contraflam
- Pyrobel
- Fire Mono
- Pyranova
- Panels

Installation of infill units

Dry glazing with EPDM gaskets or wet glazing with intumescent strip (extremely fire-resistant)

Approved door actuators

- Dorma
- GEZE
- Gilgen Door Systems
- Tormax
- Record

The subsequent commissioning of the sliding system must always be carried out by the actuator supplier.

Absicherung Gefahrenstellen

Bei einer elektrisch betriebenen Brand-schutzschiebetüre handelt es sich rechtlich gesehen um ein Maschinen-bauteil welches für Personen, insbesondere für Kinder, diverse Gefahren-stellen birgt. Die Maschinenrichtlinie 2006/42/EG sowie die Norm für automatische Schiebetüren EN 16005 schreiben zwingend vor, dass eine Risikobeurteilung der Gefahrenstellen und Massnahmen zur Absicherung dieser vorgenommen werden müssen.

Die Jansen-Brandschutzschiebetüren bieten vielfältige Möglichkeiten um die individuellen Sicherheitsanforderungen abzudecken. Kombiniert mit den Sicherheitselementen der Antriebshersteller können die Gefahrenstellen zuverlässig abgesichert werden.

Wir empfehlen dem Hersteller einer Brandschutzschiebetüre die Ansteuerung der Schiebe- und Fluchtflügel sowie die Absicherung der Gefahrenstellen in Zusammenarbeit mit dem Antriebslieferanten zu bestimmen. Die anschliessende Inbetriebnahme der Schiebeanlage sowie deren CE-Kennzeichnung nach EN 16005 hat ausschliesslich durch den Antriebslieferanten zu erfolgen.

Sécurisation des zones dangereuses

Du point de vue juridique, la porte coulissante coupe-feu à commande électrique est un composant de machine recélant pour les personnes et en particulier les enfants diverses zones dangereuses. La directive relative aux machines 2006/42/CE ainsi que la norme pour portes coulissantes automatiques EN 16005 requièrent impérativement de procéder à une évaluation des risques des zones dangereuses et de prendre des mesures pour les sécuriser.

Les portes coulissantes coupe-feu Jansen offrent de nombreuses possibilités destinées à répondre aux exigences individuelles de sécurité. Les zones dangereuses peuvent être sécurisées de manière fiable en utilisant des éléments de sécurité des fabricants d'entraînements.

Nous recommandons aux fabricants d'une porte coulissante coupe-feu de se concerter avec le fournisseur de l'entraînement pour déterminer la commande des vantaux coulissants et à défoncement ainsi que la sécurisation des zones dangereuses. Seul le fournisseur d'entraînements a le droit de procéder à la mise en service de l'installation coulissante et à son marquage CE selon EN 16005.

Securing danger points

In legal terms, an electrically-operated fire-resistant sliding door is a mechanical component that poses a range of dangers to people and, in particular, children. The Machinery Directive 2006/42/EC and the EN 16005 standard for automatic sliding doors prescribe that a risk assessment of the danger points must be carried out and that measures must be taken to secure these.

The Jansen fire-resistant sliding doors offer a wide variety of options for addressing individual safety requirements. Combined with the safety units from the actuator manufacturer, the danger points can be secured reliably.

We recommend that the method of controlling the sliding and emergency exit vents and the way in which the danger points are to be secured are determined by the manufacturer of the fire-resistant sliding doors in cooperation with the actuator supplier. The subsequent commissioning of the sliding system and its CE marking in accordance with EN 16005 must be done exclusively by the drive supplier.

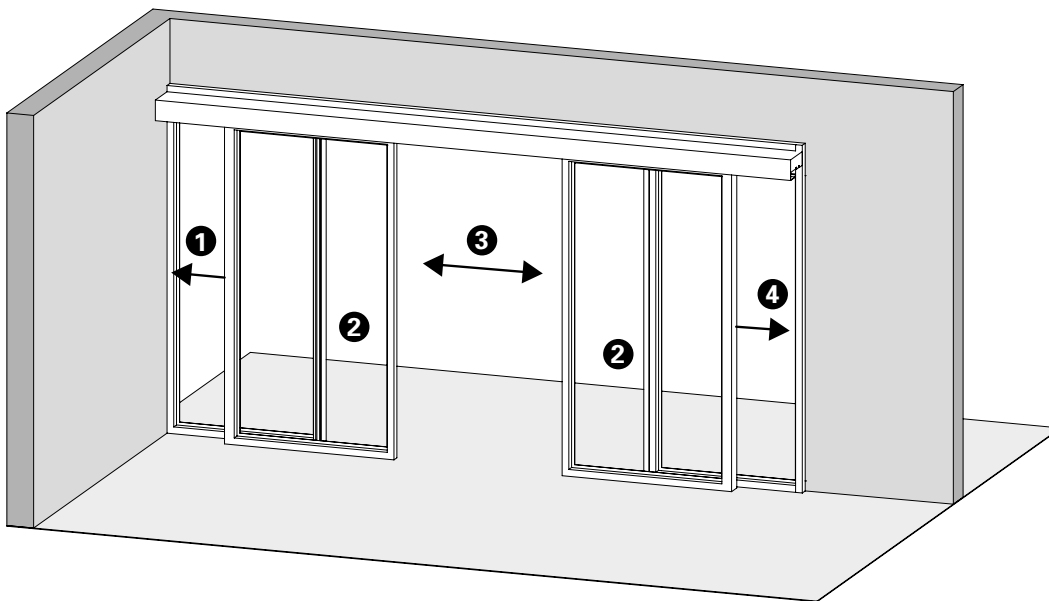

- 1 Quetschgefahr
- 2 Scher- und Einzugsgefahr
- 3 Stoss- und Quetschgefahr
- 4 Stossgefahr

- 1 Risque d'écrasement
- 2 Risque de cisaillement et de happage
- 3 Risque de choc et d'écrasement
- 4 Risque de choc

- 1 Risk of crushing
- 2 Risk of shearing and entanglement hazard
- 3 Risk of collision and crushing
- 4 Risk of collision

Fluchttür-Funktion

Fonction porte de secours

Emergency exit function

Break-Out

Break-Out

Break-Out

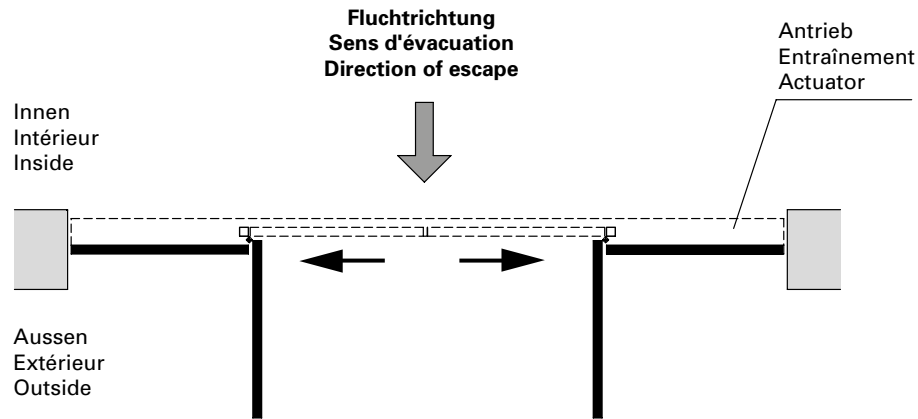

- Diese Situation gewährleistet die Fluchttürfunktion nur bei geschlossenen Schiebeflügel.
- EN 179 und 1125 erfüllt

- Cette situation ne garantit la fonction porte de secours que quand les vantaux coulissants sont fermés.
- EN 179 et 1125 satisfaites

- This scenario only guarantees the emergency exit function when the sliding vents are closed.
- Fulfils EN 179 and 1125

Break-In

Break-In

Break-In

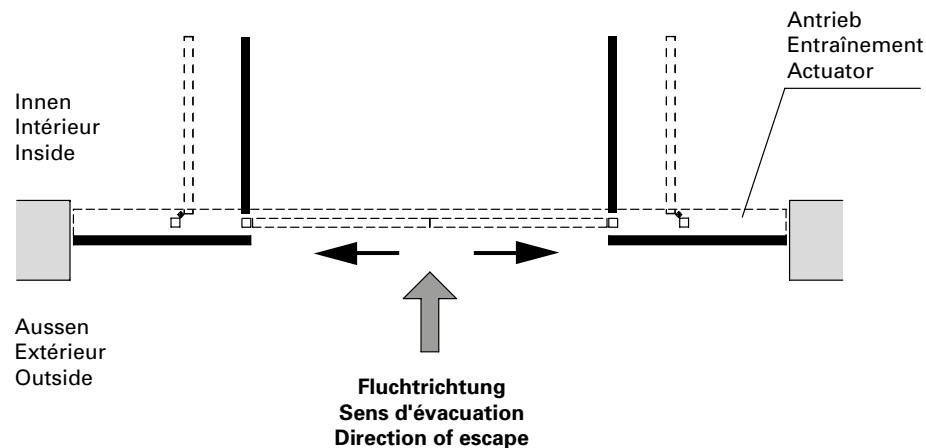

- Diese Situation gewährleistet die Fluchttürfunktion zu jeder Zeit und in jeder Schiebeflügelposition.
- Diese Lösung entspricht den schweizerischen Brandschutz-Vorschriften und der Fluchtweg-verordnung.
- EN 179 erfüllt
- EN 1125 nicht erfüllt

- Cette situation garantit toujours la fonction porte de secours, dans n'importe quelle position des vantaux coulissants.
- Cette solution répond aux prescriptions suisses relatives à la protection contre les incendies et à l'ordonnance sur les issues de secours.
- EN 179 satisfaite
- EN 1125 non satisfaite

- This scenario guarantees the emergency exit function at all times and with the sliding vents in any position.
- This solution conforms to the Swiss fire protection regulations and the escape route directive.
- Fulfils EN 179
- Does not fulfil EN 1125

Schiebetüren

Portes coulissantes

Sliding doors

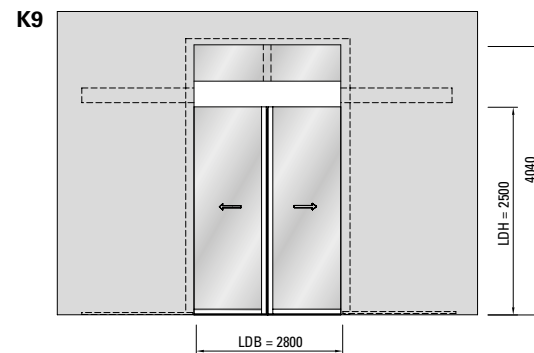
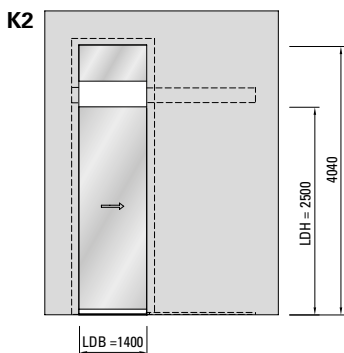
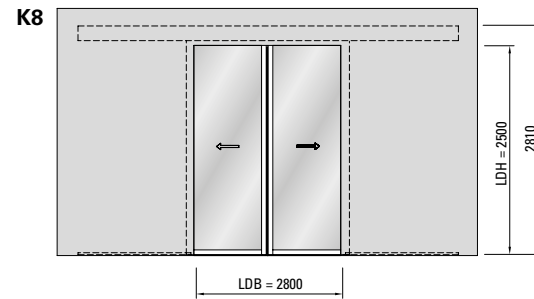
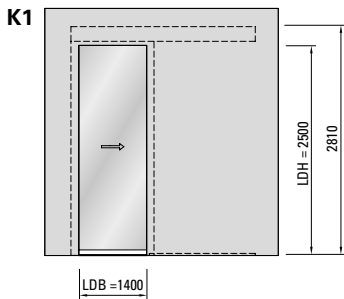
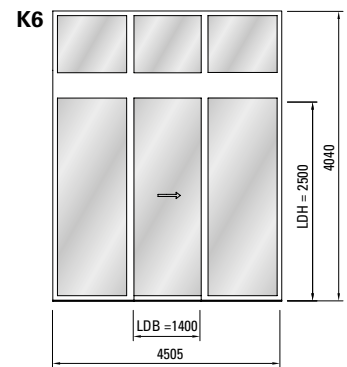
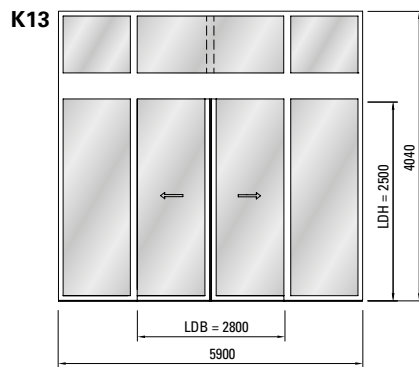
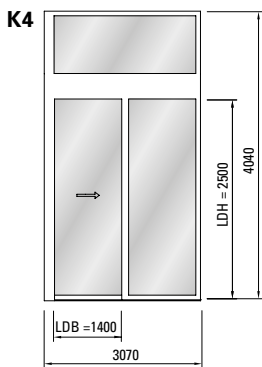
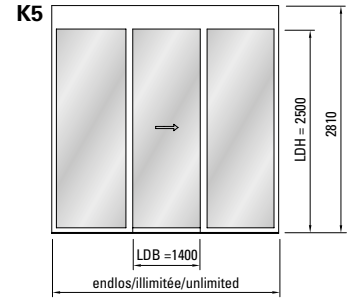
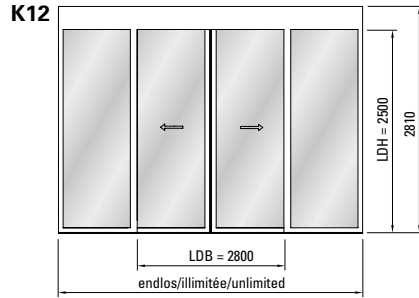
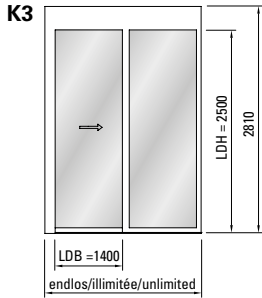

Variante mit Riegel
 Variante avec montant
 Version with mullion

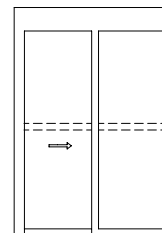

LDB Lichte Durchgangsbreite
 LDH Lichte Durchgangshöhe

LDB Largeur libre de passage
 LDH Hauteur libre de passage

LDB Inside width
 LDH Inside height

Schiebetüren mit Break-Out Fluchttürfunktion

Portes coulissantes avec fonction porte de secours Break-Out

Sliding doors with Break-Out emergency exit function

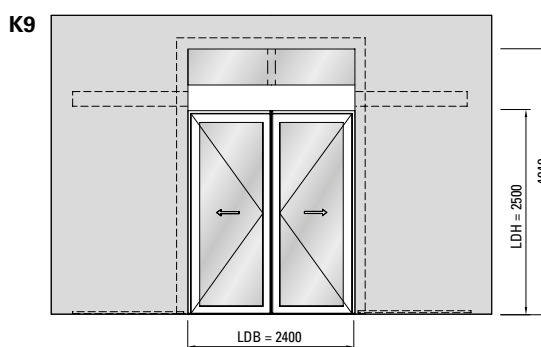
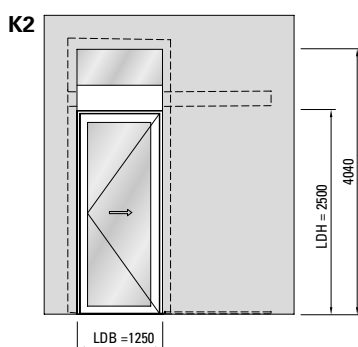
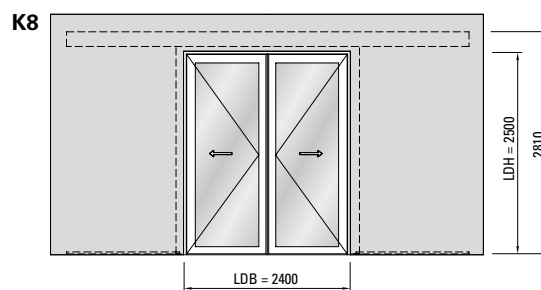
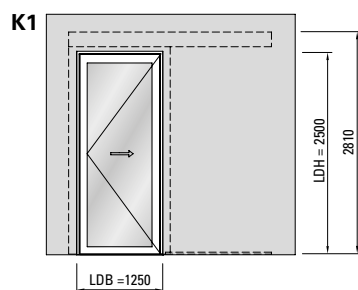
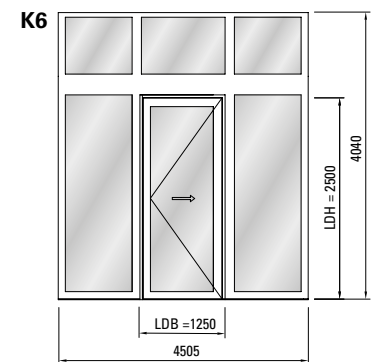
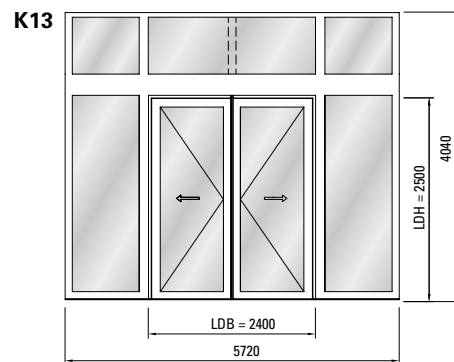
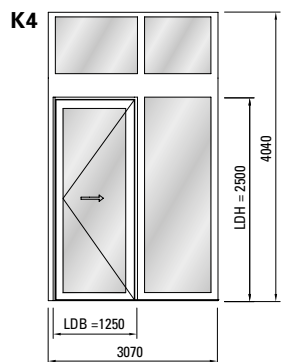
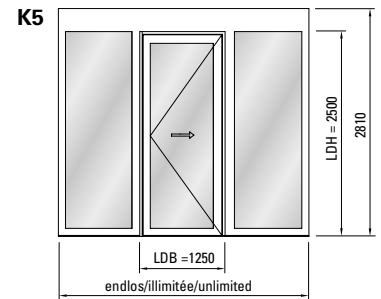
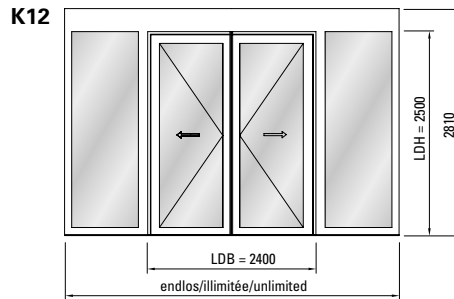
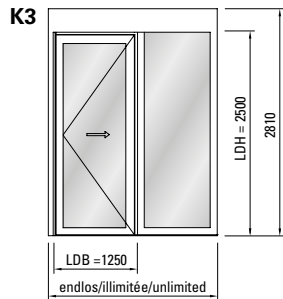

Variante mit Riegel
 Variante avec montant
 Version with mullion

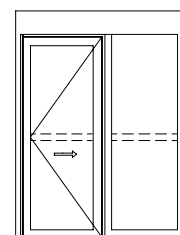

LDB Lichte Durchgangsbreite
 LDH Lichte Durchgangshöhe

LDB Largeur libre de passage
 LDH Hauteur libre de passage

LDB Inside width
 LDH Inside height

Schiebetüren mit Break-In Fluchttürfunktion

Portes coulissantes avec fonction porte de secours Break-In

Sliding doors with Break-In emergency exit function

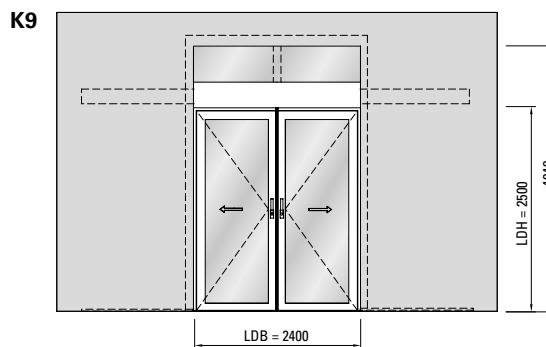
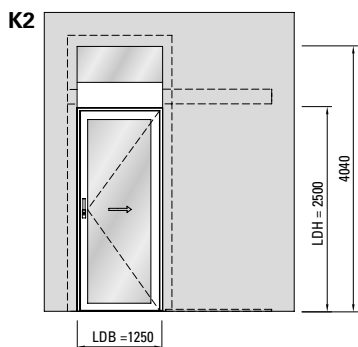
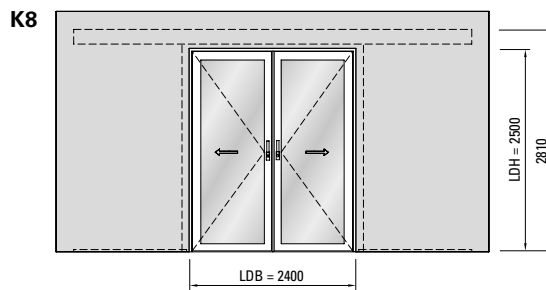
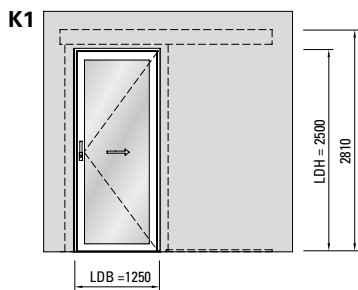
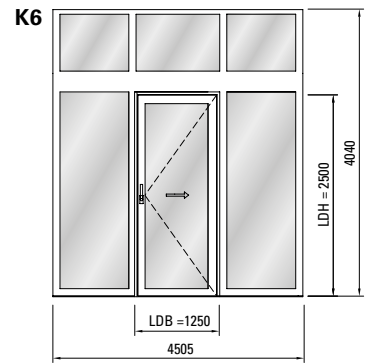
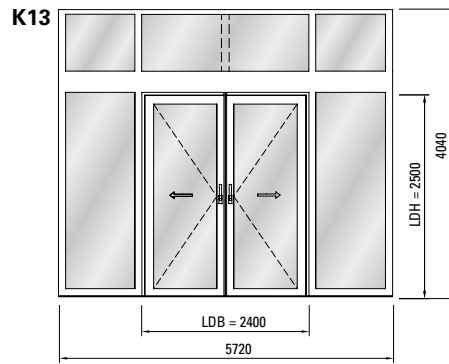
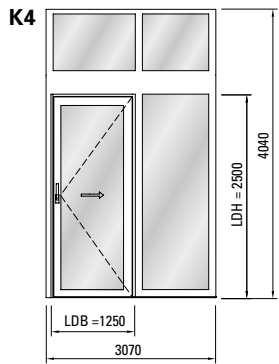
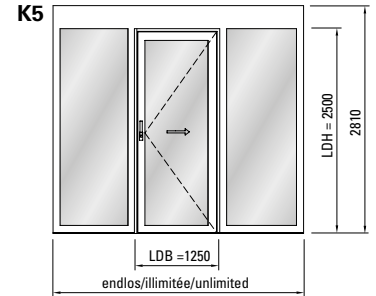
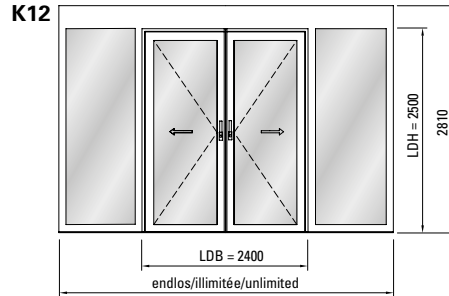
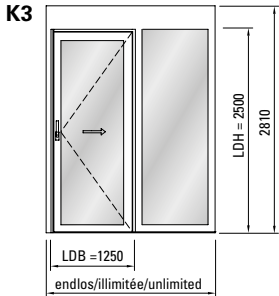

Variante mit Riegel
 Variante avec montant
 Version with mullion

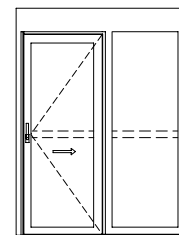

LDB Lichte Durchgangsbreite
 LDH Lichte Durchgangshöhe

LDB Largeur libre de passage
 LDH Hauteur libre de passage

LDB Inside width
 LDH Inside height

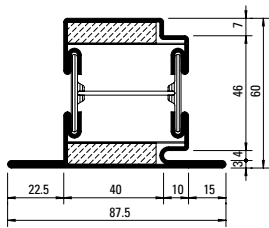

630.114.2
630.114.2 Z

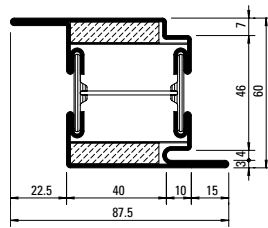

630.416.2
630.416.2 Z

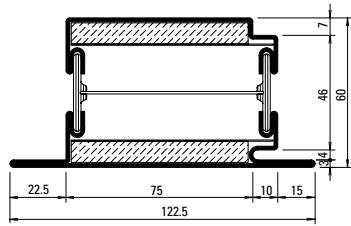

630.115.2
630.115.2 Z

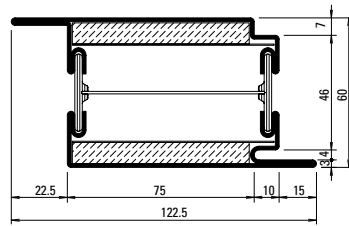

630.417.2
630.417.2 Z

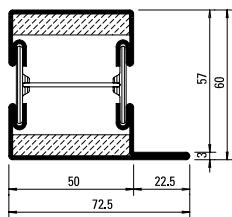

601.685.2
601.685.2 Z

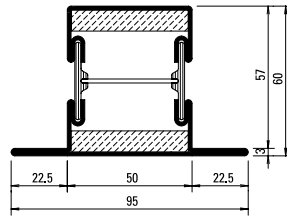

602.685.2
602.685.2 Z

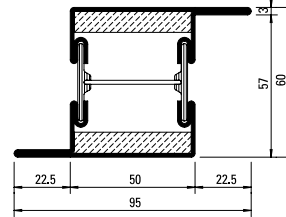

603.685.2
603.685.2 Z

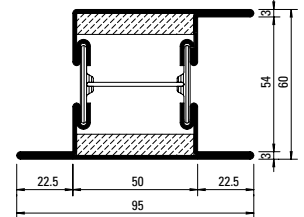

605.685.2
605.685.2 Z

Profil-Nr.	G kg/m	Ix cm ⁴	Wx cm ³	Iy cm ⁴	Wy cm ³	U m ² /m
601.685.2 Z	4,880	19,3	5,31	21,7	5,12	0,265
602.685.2 Z	5,400	22,1	5,58	31,1	6,54	0,310
603.685.2 Z	5,400	24,2	7,57	31,1	6,54	0,310
605.685.2 Z	5,920	28,1	7,94	38,4	7,46	0,354

Profil-Nr.	G kg/m	Ix cm ⁴	Wx cm ³	Iy cm ⁴	Wy cm ³	U m ² /m
630.114.2 Z	5,590	21,4	5,36	27,4	5,93	0,317
630.416.2 Z	5,590	23,7	7,32	27,4	5,93	0,317
630.115.2 Z	7,400	28,7	7,48	79,6	12,42	0,387
630.417.2 Z	7,400	30,5	9,47	79,6	12,42	0,387

Profilübersicht
Sommaire des profilés
Summary of profiles

Brandschutzschiebetüre EI30
Porte coulissante coupe-feu EI30
Fire-resistant sliding door EI30

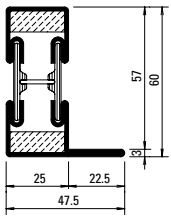

601.635.2
601.635.2 Z

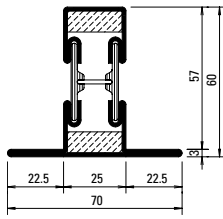

602.635.2
602.635.2 Z

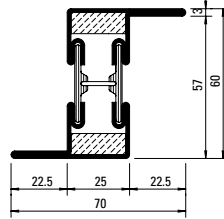

603.635.2
603.635.2 Z

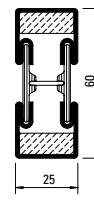

600.006.2
600.006.2 Z

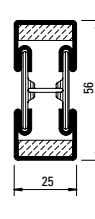

600.002.2
600.002.2 Z

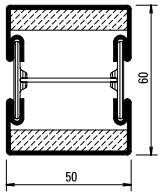

600.005.2
600.005.2 Z

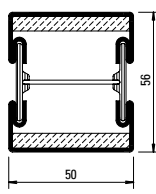

600.001.2
600.001.2 Z

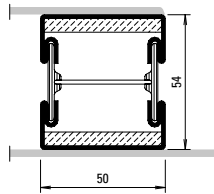

600.007.2 Z

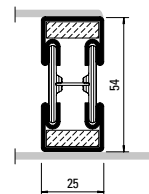

600.008.2 Z

Stabachse
Axe de la barre
Bar axis

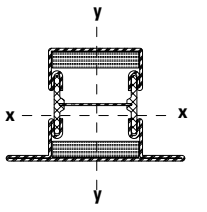

Artikelbibliothek
 Bibliothèque des articles
 Article library

DXF **DWG**

Oberfläche/Werkstoff

Artikel-Nr.

ohne Zusatz = blank

mit Z = bandverzinkter Stahl

Surface/Matériau

No. d'article

sans supplément = brut

avec Z = bande d'acier zinguée

Surface/Material

Part no.

without addition = bright

with Z = strip galvanised steel

Profil-Nr.	G kg/m	I _x cm ⁴	W _x cm ³	I _y cm ⁴	W _y cm ³	U m ² /m
601.635.2 Z	3,800	14,0	3,78	5,84	1,88	0,215
602.635.2 Z	4,310	16,6	4,07	10,10	2,88	0,260
603.635.2 Z	4,310	19,1	5,97	10,10	2,88	0,260

Profil-Nr.	G kg/m	I _x cm ⁴	W _x cm ³	I _y cm ⁴	W _y cm ³	U m ² /m
600.001.2 Z	4,080	13,5	4,53	14,0	5,58	0,213
600.002.2 Z	3,100	9,06	3,03	2,60	2,08	0,163
600.005.2 Z	4,360	15,6	4,87	14,6	5,84	0,221
600.006.2 Z	3,280	10,4	3,26	2,76	2,20	0,171
600.007.2 Z	4,000	12,49	4,34	13,65	5,46	0,220
600.008.2 Z	3,080	10,12	3,75	2,80	2,24	0,170

Schiebetüren

Portes coulissantes

Sliding doors

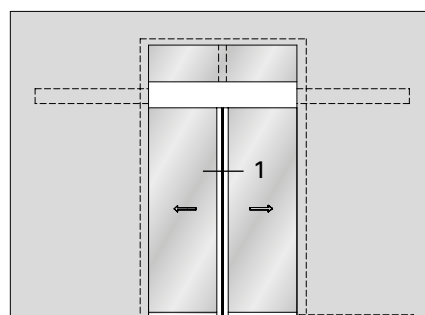
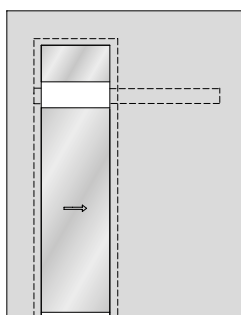
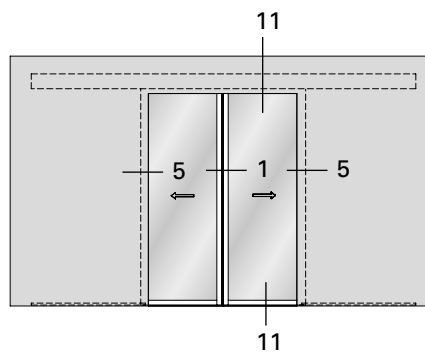
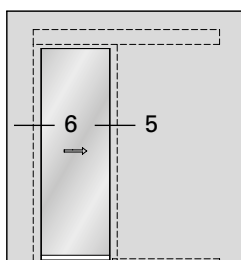
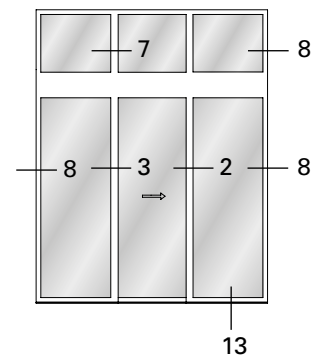
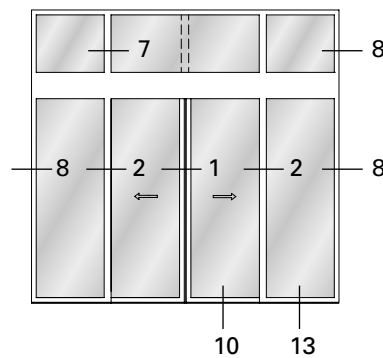
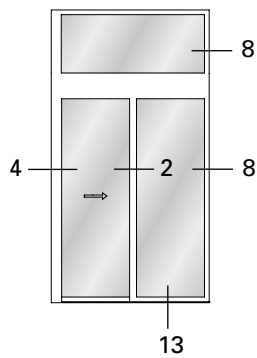
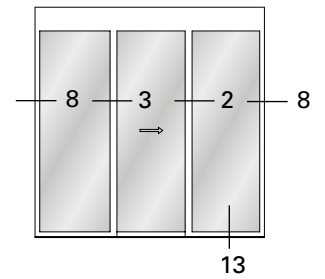
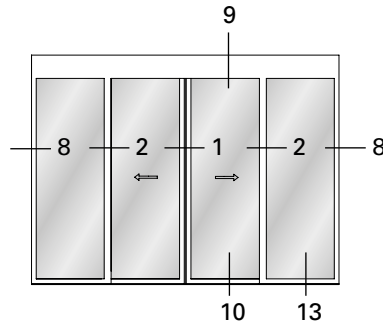
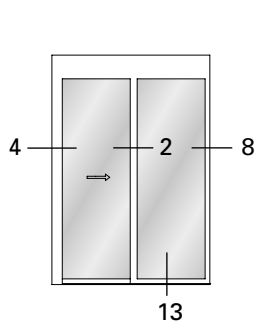

Variante mit Riegel
 Variante avec montant
 Version with mullion

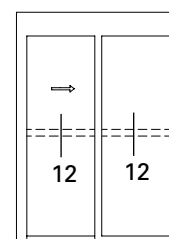

Schnittpunkte Schiebetüren im Massstab 1:2
Coupe de détails portes coulissantes à l'échelle 1:2
Section details sliding doors on scale 1:2

Brandschutzschiebetüre EI30
Porte coulissante coupe-feu EI30
Fire-resistant sliding door EI30

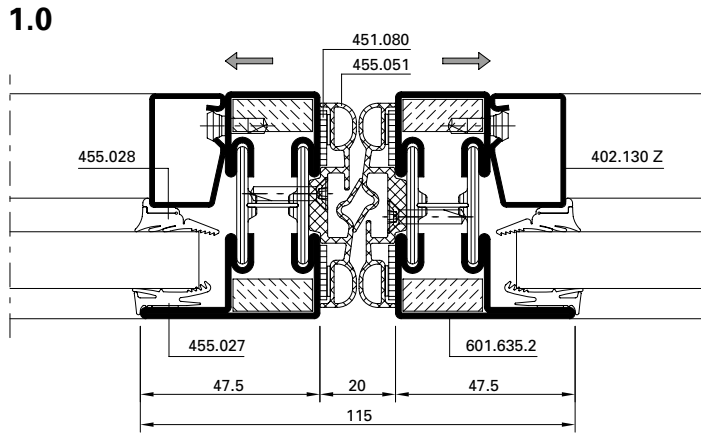

DXF DWG 31-0501-C-001

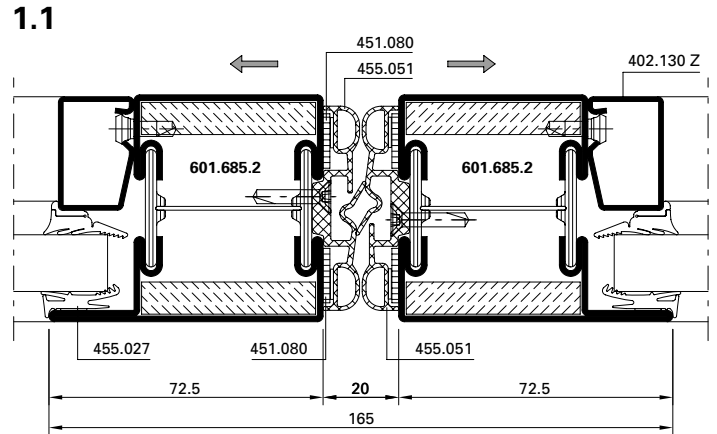

DXF DWG 31-0501-C-002

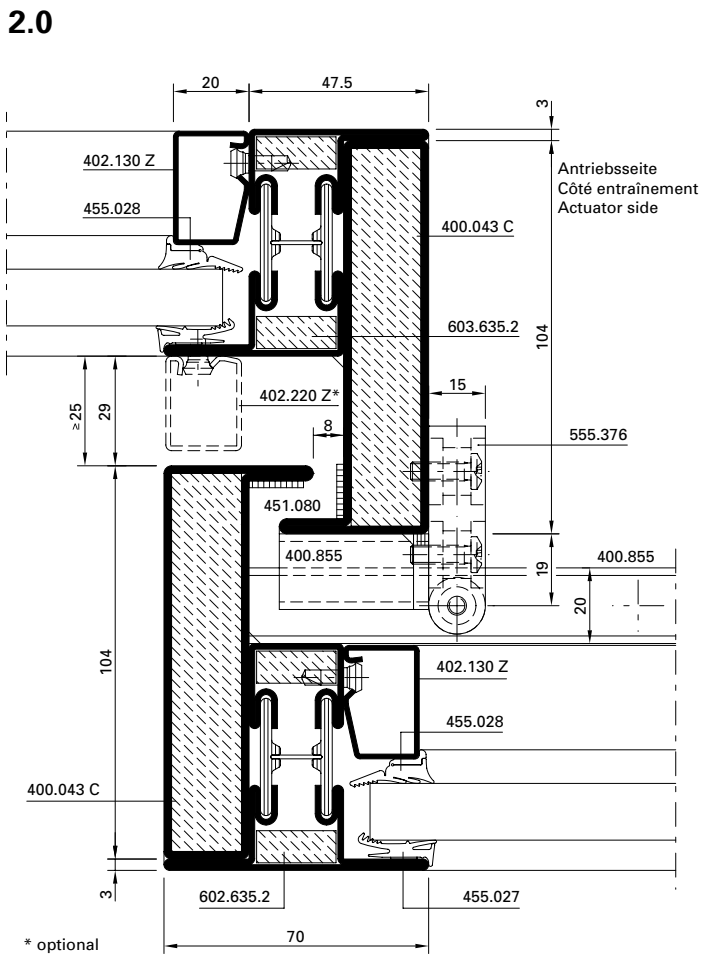

DXF DWG 31-0501-C-003

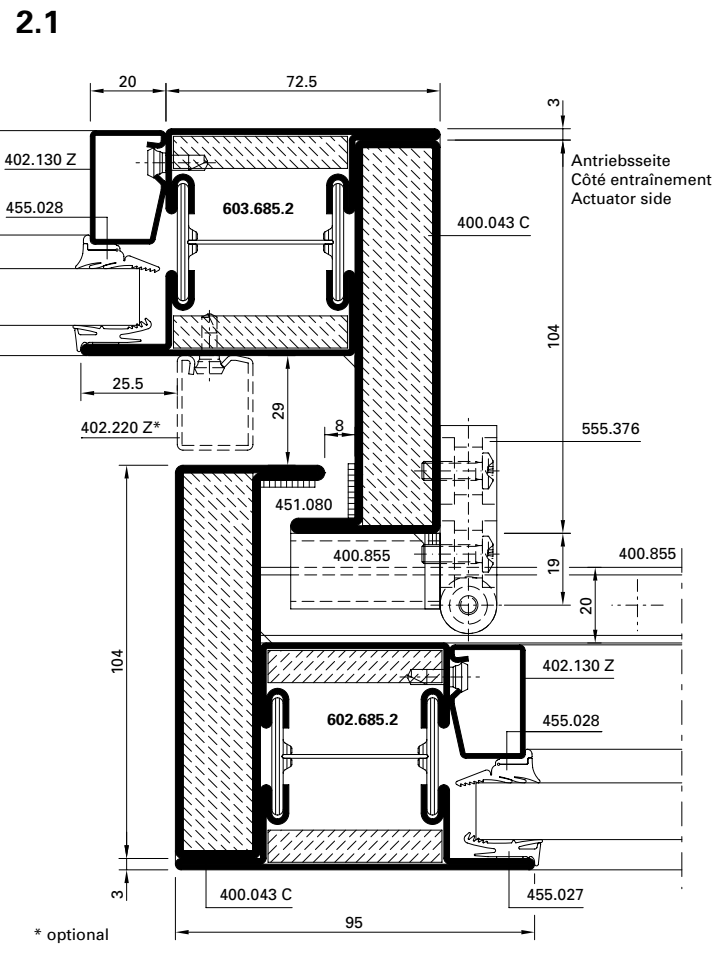

DXF DWG 31-0501-C-007

Schnittpunkte Schiebetüren im Massstab 1:2
Coupe de détails portes coulissantes à l'échelle 1:2
Section details sliding doors on scale 1:2

Brandschutzschiebetüre EI30
Porte coulissante coupe-feu EI30
Fire-resistant sliding door EI30

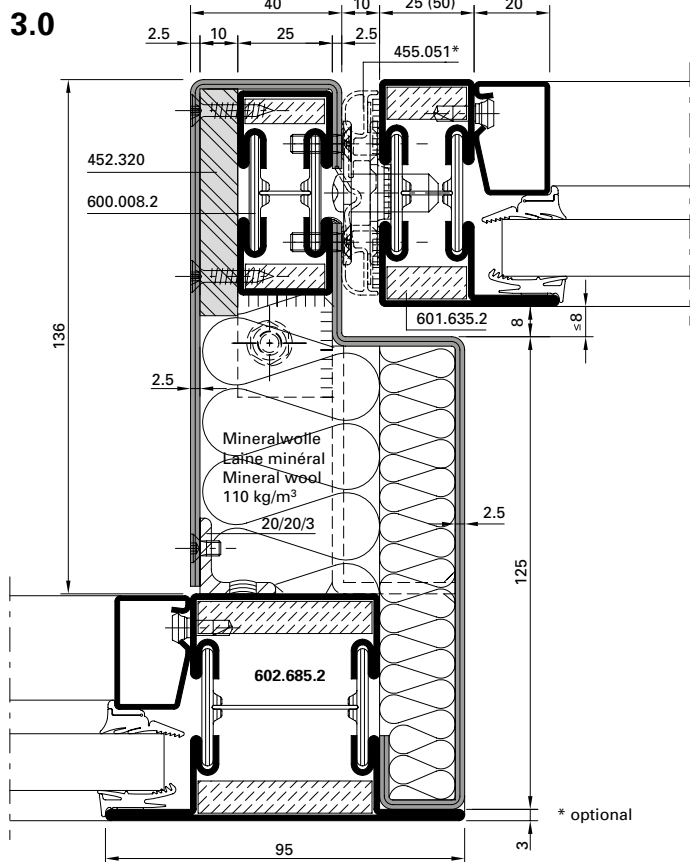

DXF DWG 31-0501-C-009

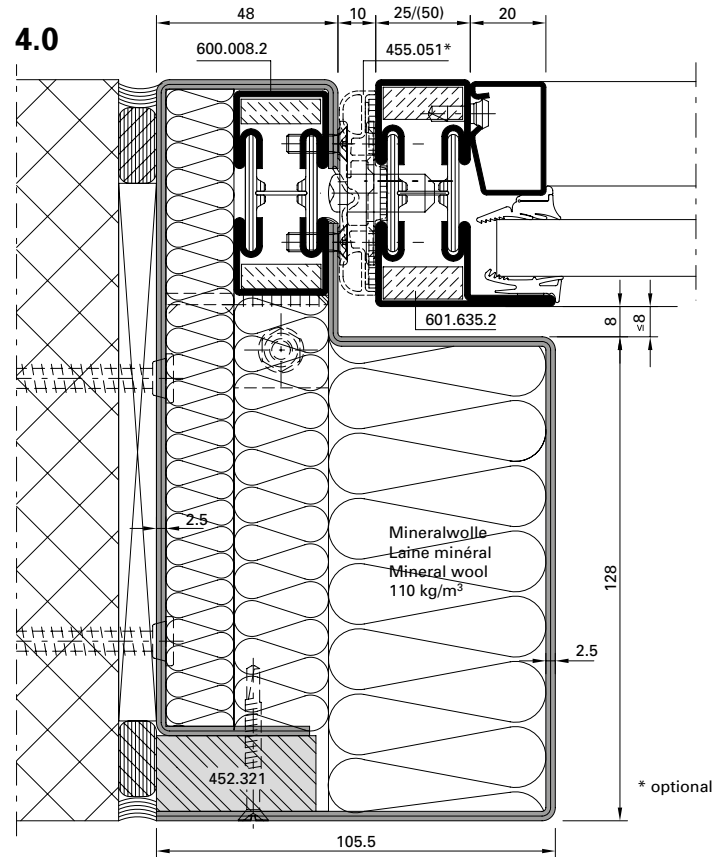

DXF DWG 31-0501-C-008

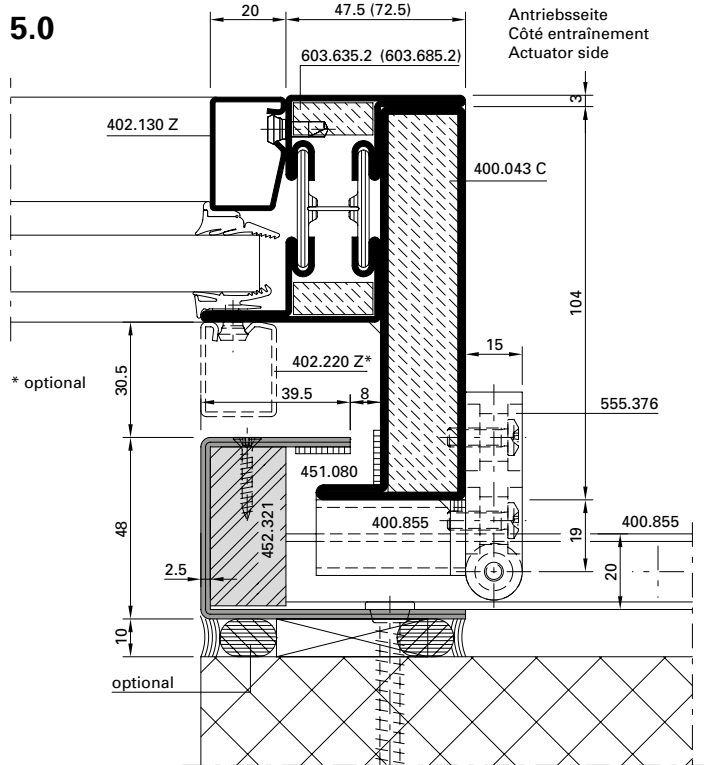

DXF DWG 31-0501-C-005

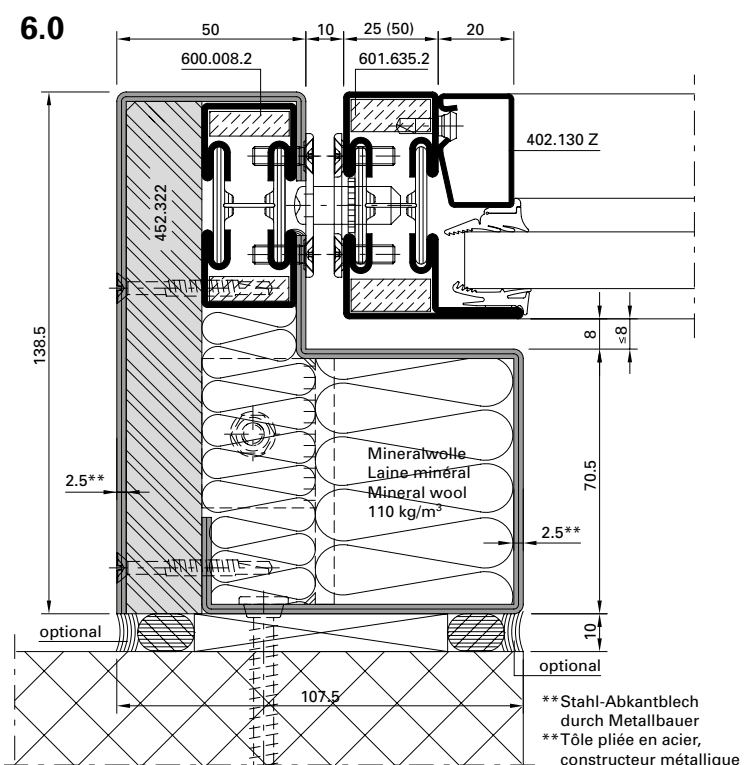

DXF DWG 31-0501-C-010

** Stahl-Abkantblech durch Metallbauer
 ** Tôle pliée en acier, constructeur métallique
 ** Steel formed sheet from metal fabricator

Schnittpunkte Schiebetüren im Massstab 1:2
Coupe de détails portes coulissantes à l'échelle 1:2
Section details sliding doors on scale 1:2

Brandschutzschiebetüre EI30
Porte coulissante coupe-feu EI30
Fire-resistant sliding door EI30

7.0

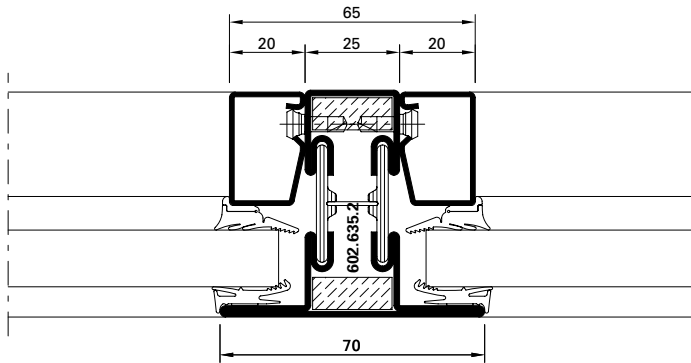

DXF **DWG** 31-0501-C-016

7.1

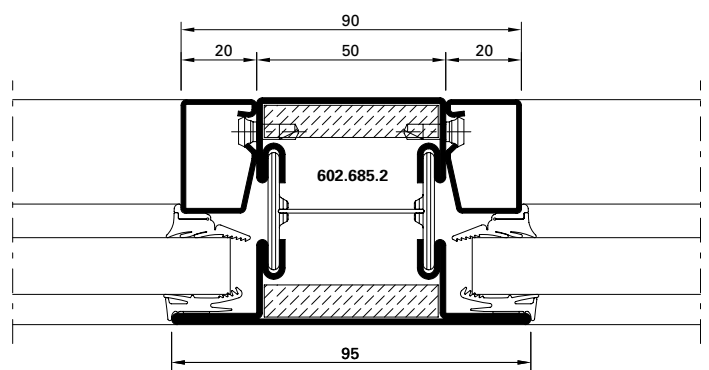

DXF **DWG** 31-0501-C-017

7.2

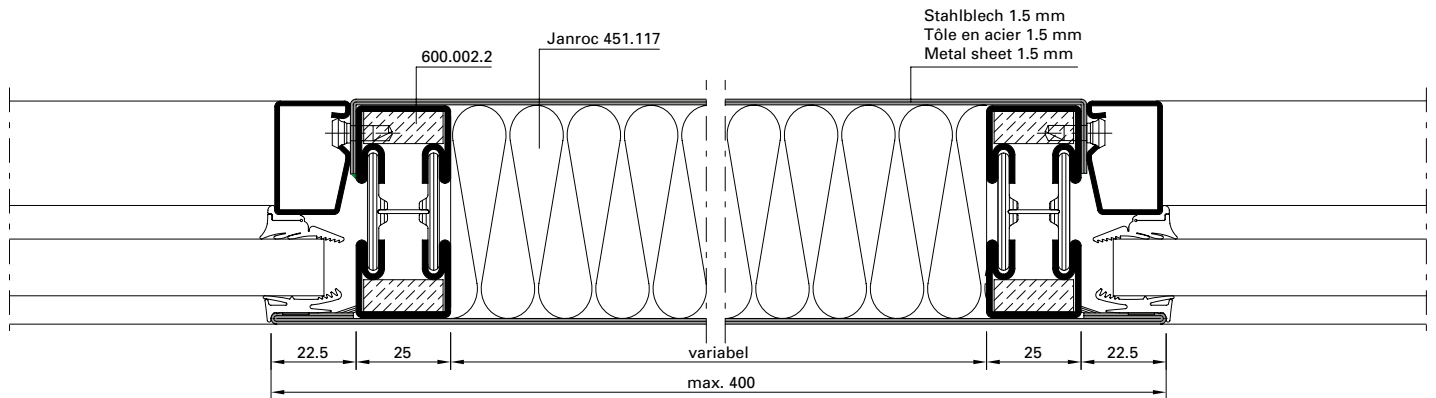

DXF **DWG** 31-0501-C-018

7.3

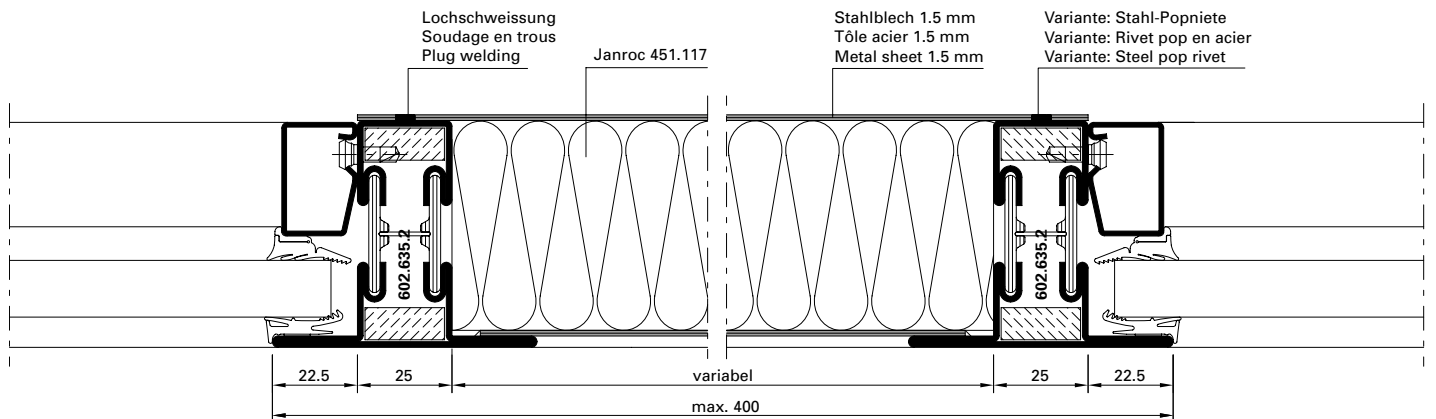

DXF **DWG** 31-0501-C-019

Schnittpunkte Schiebetüren im Massstab 1:2
Coupe de détails portes coulissantes à l'échelle 1:2
Section details sliding doors on scale 1:2

Brandschutzschiebetüre EI30
Porte coulissante coupe-feu EI30
Fire-resistant sliding door EI30

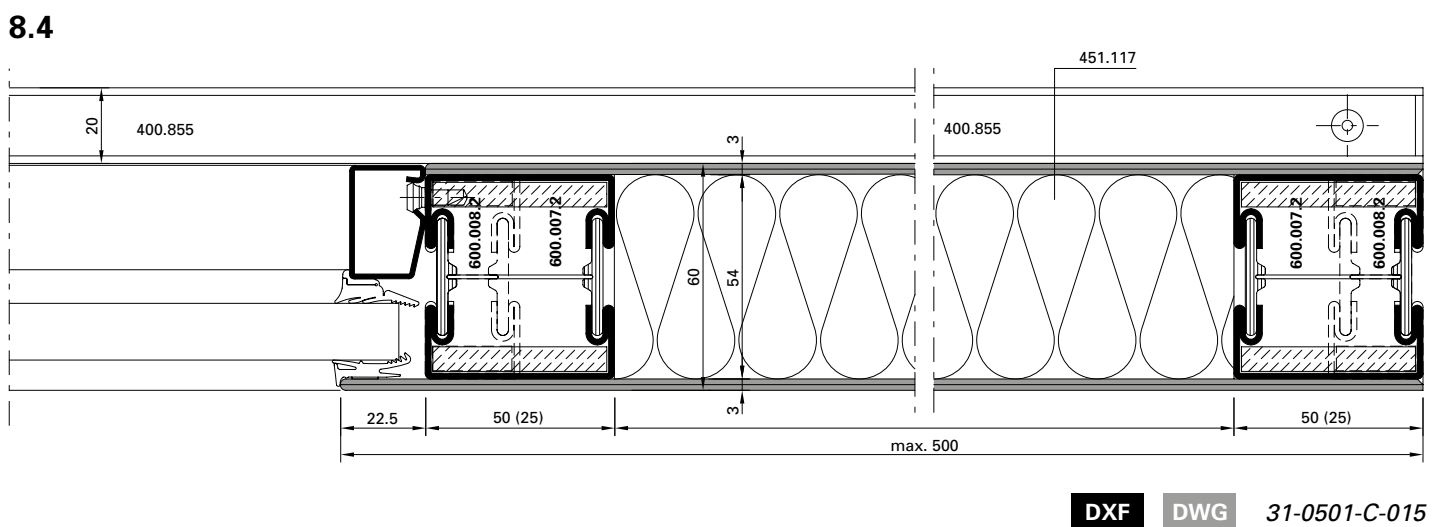
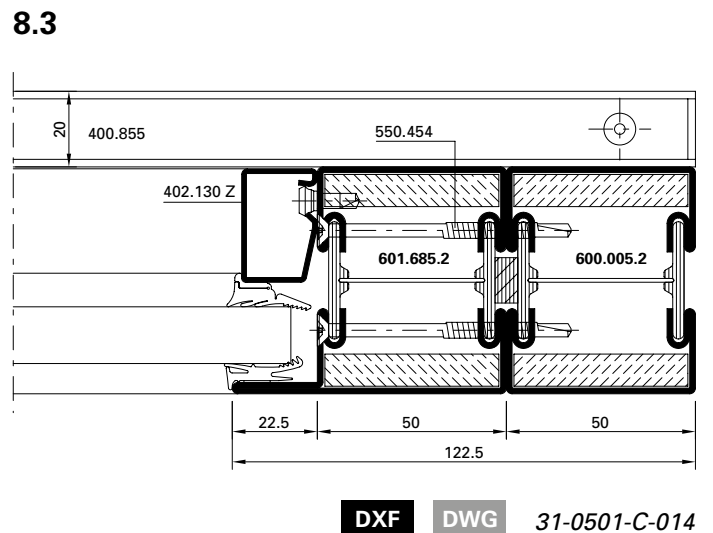
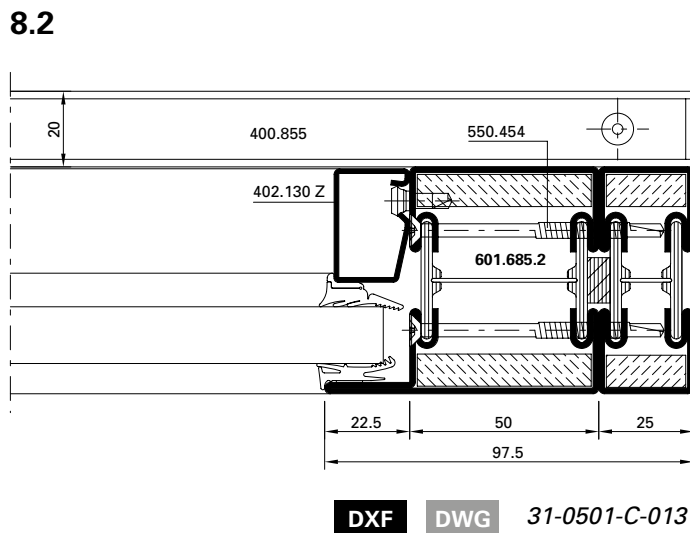
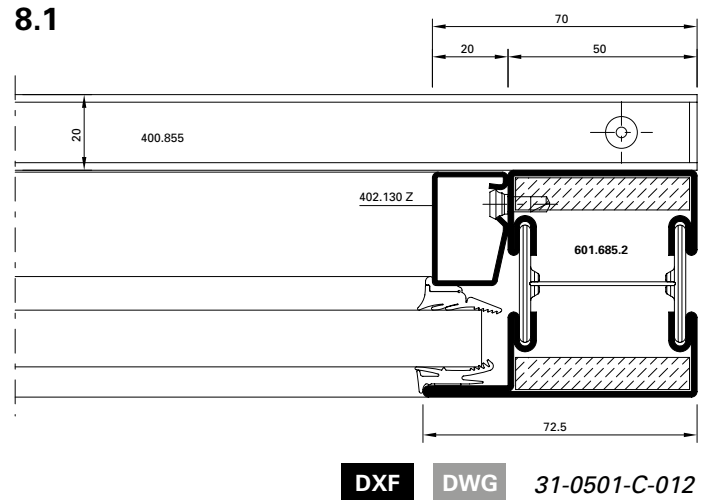
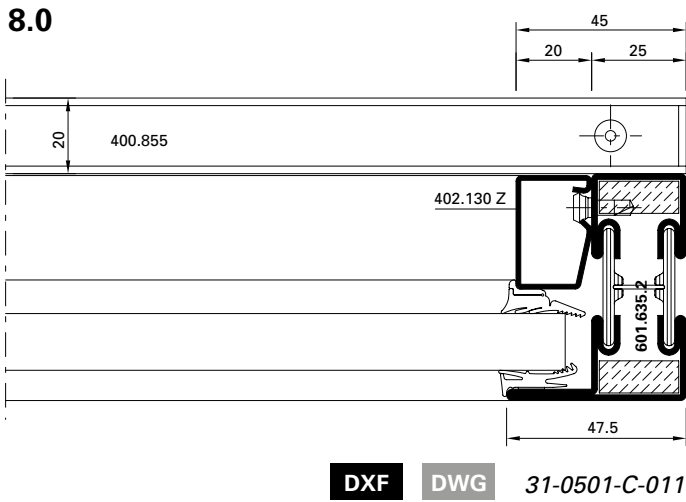

9.0

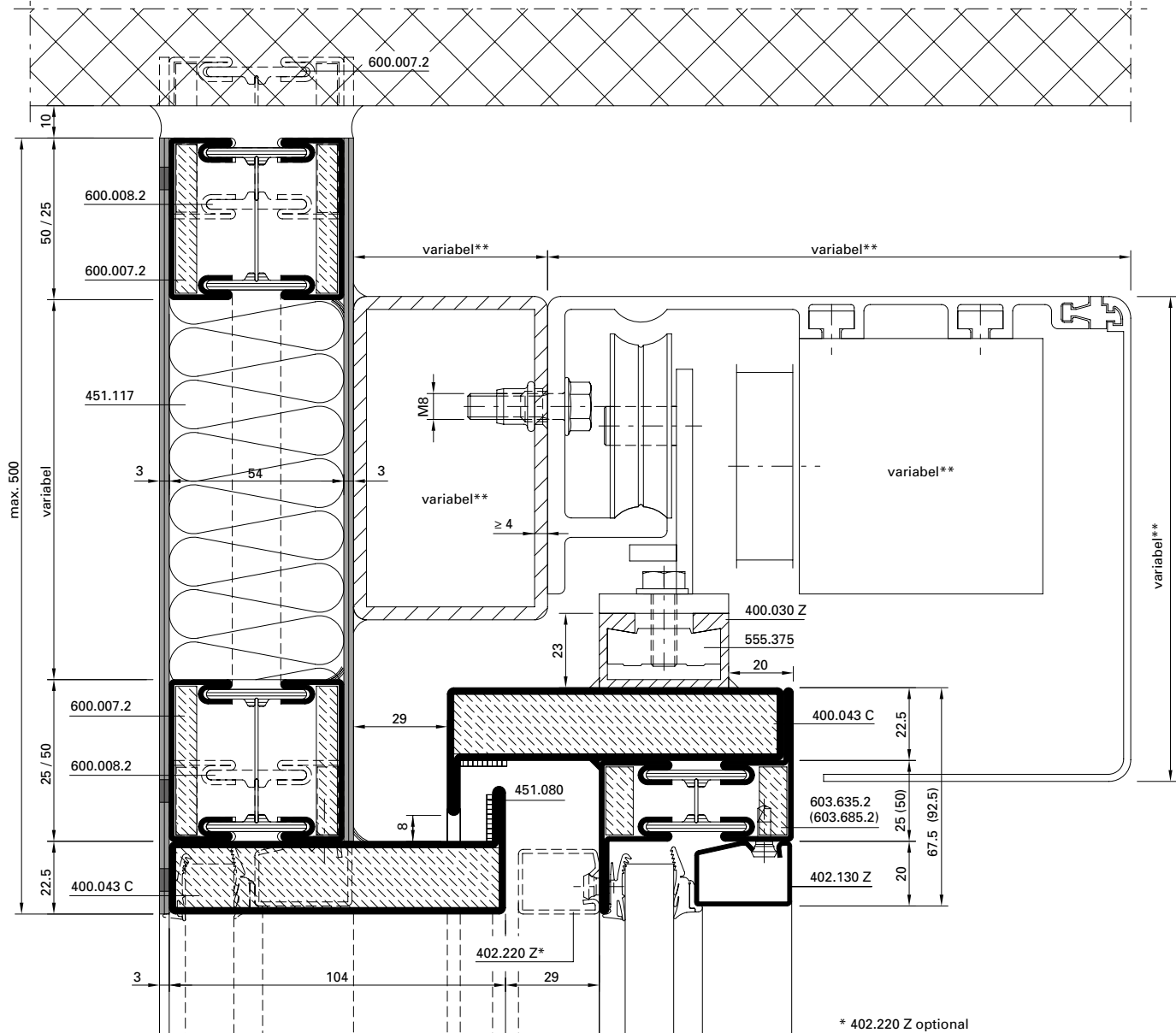

10.0

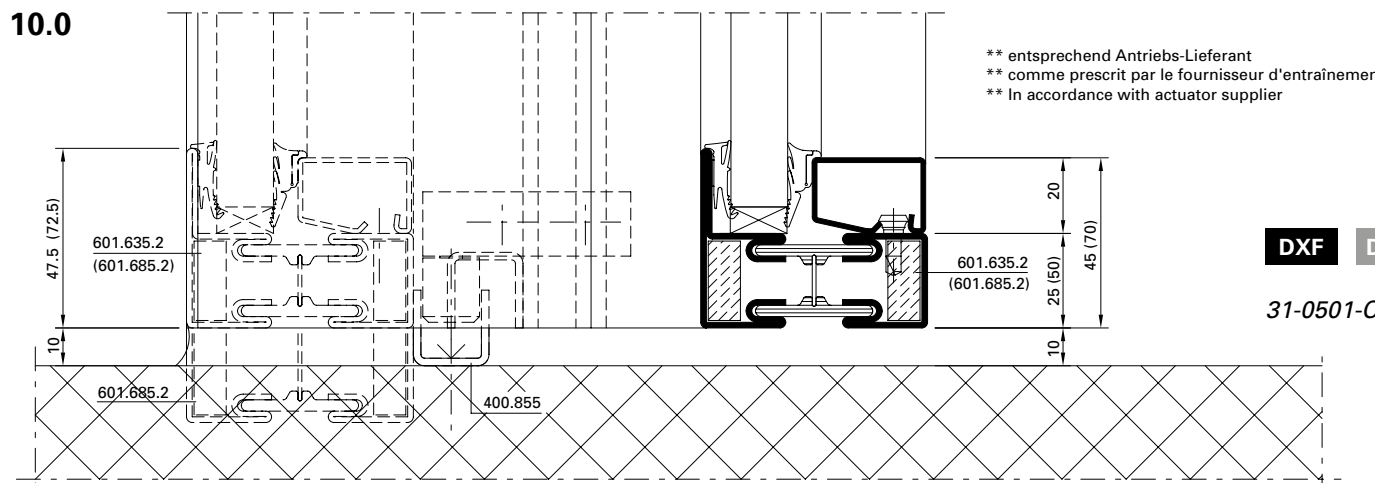

DXF DWG

31-0501-C-020

11.0

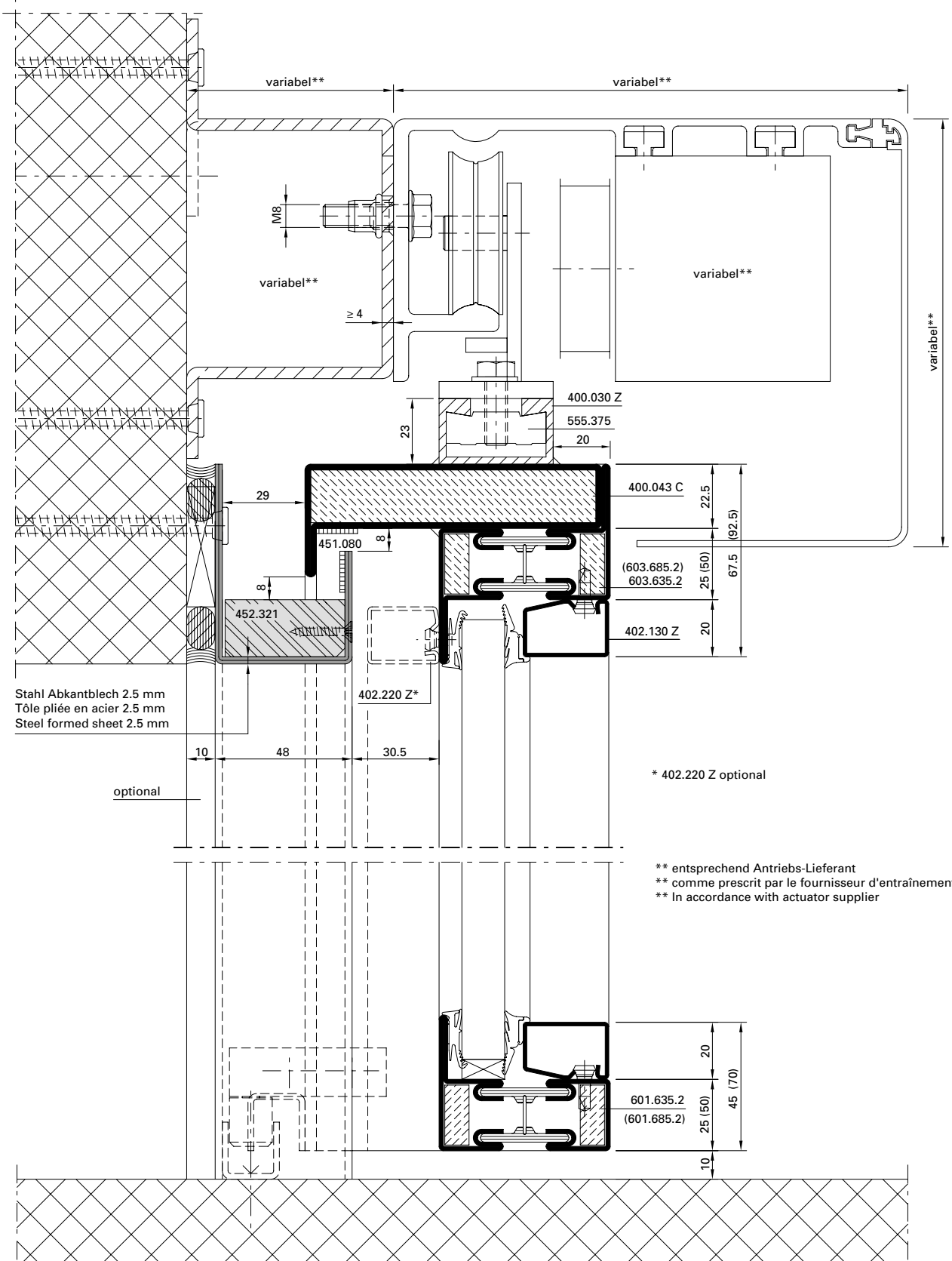

DXF **DWG**

31-0501-C-021

12.0

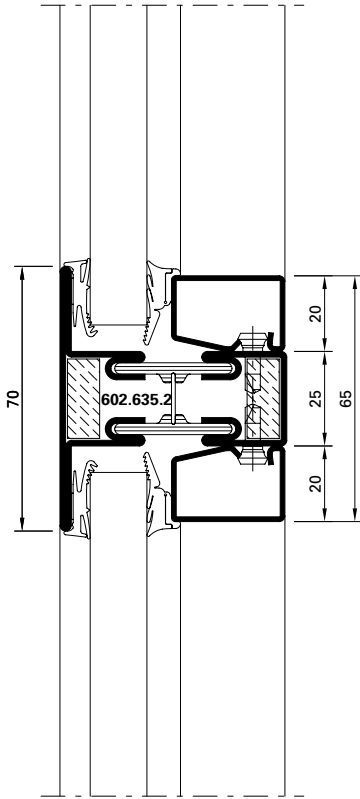

31-0501-C-023

DWG
DXF

12.1

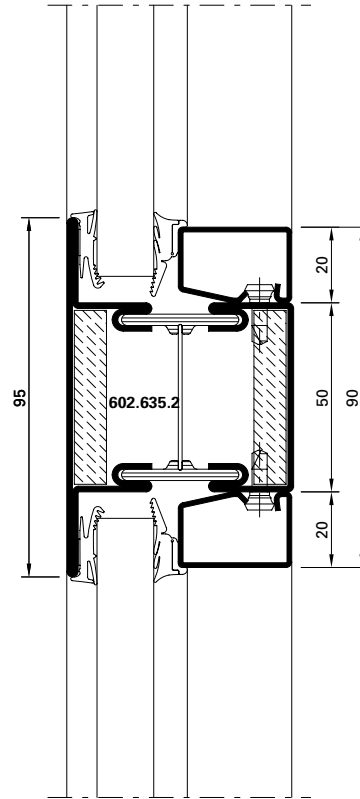

31-0501-C-022

DWG
DXF

12.2

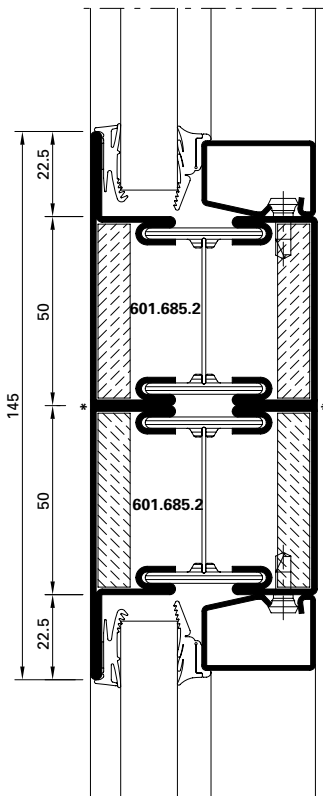

31-0501-C-024

DWG
DXF

* Durchgehende Laserschweißung
 * Soudage au laser en continu
 * Continuous laser welding

12.3

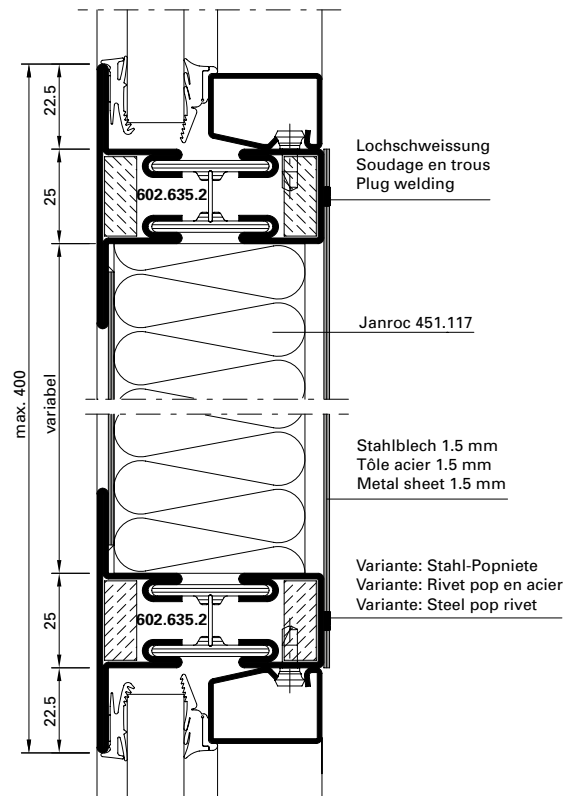

31-0501-C-025

DWG
DXF

13.0

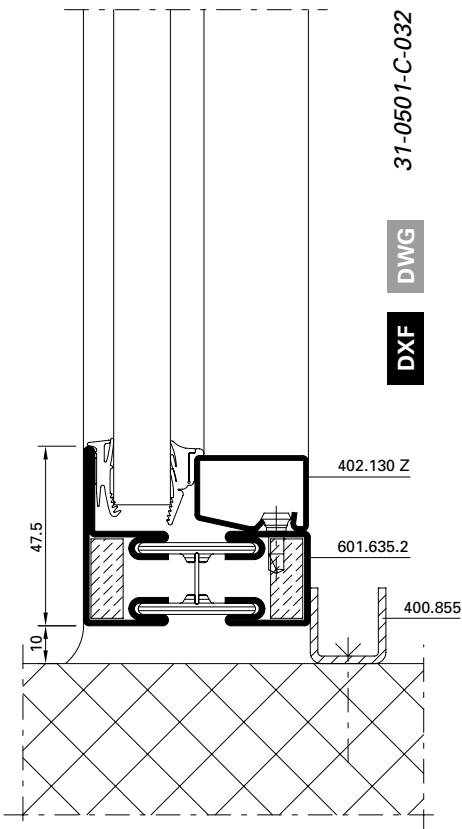

13.1

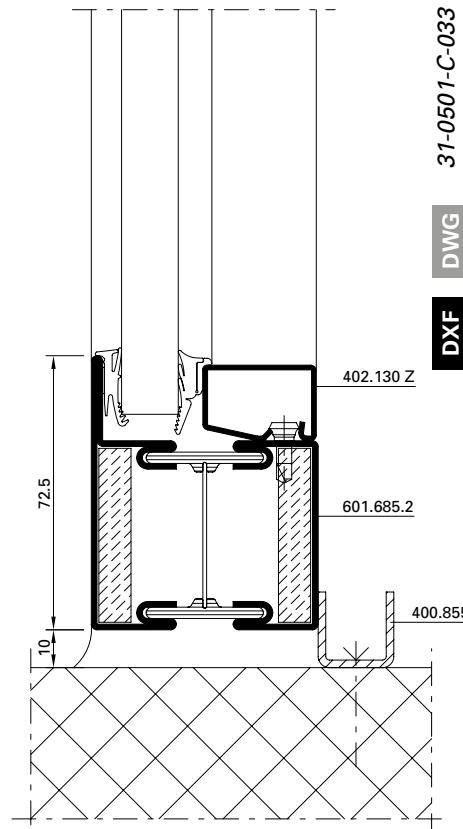

13.3

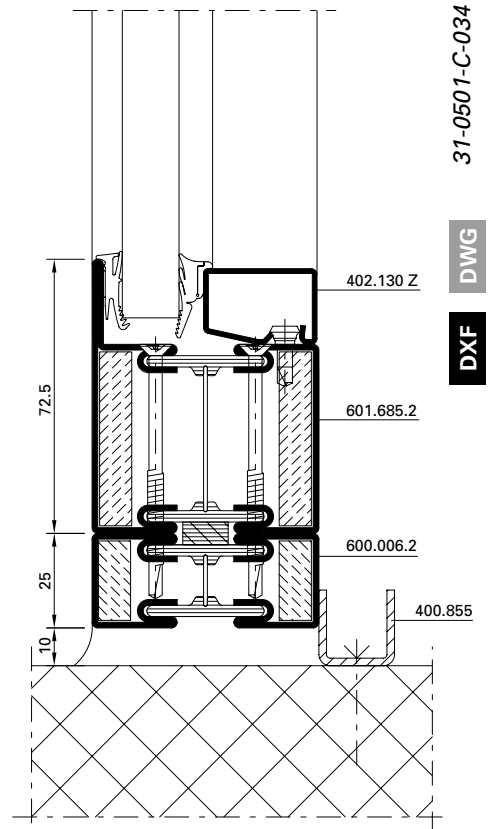

13.4

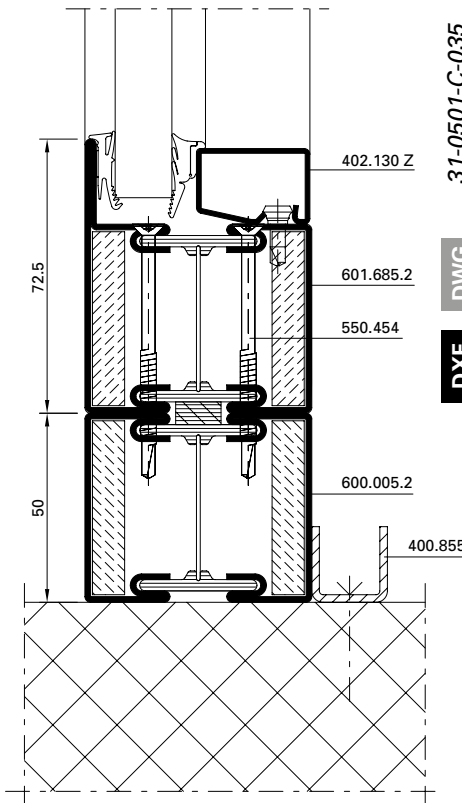

13.5

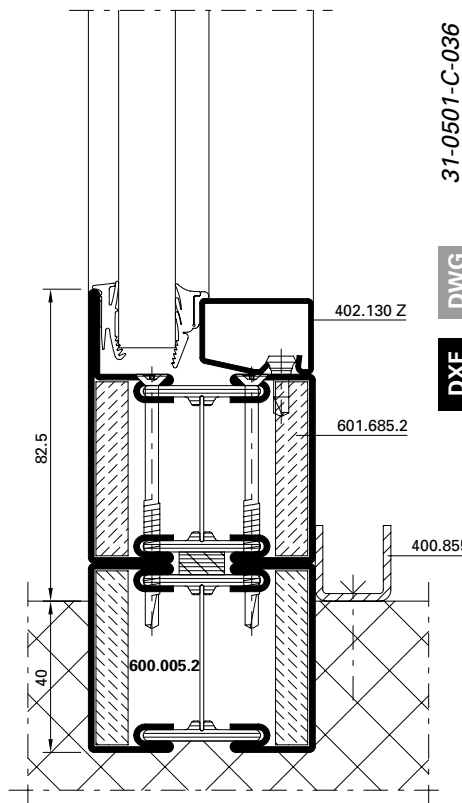

13.6

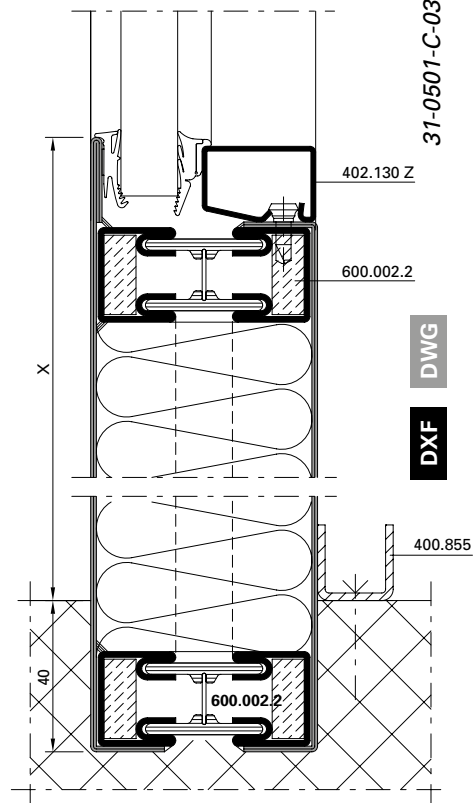

13.7

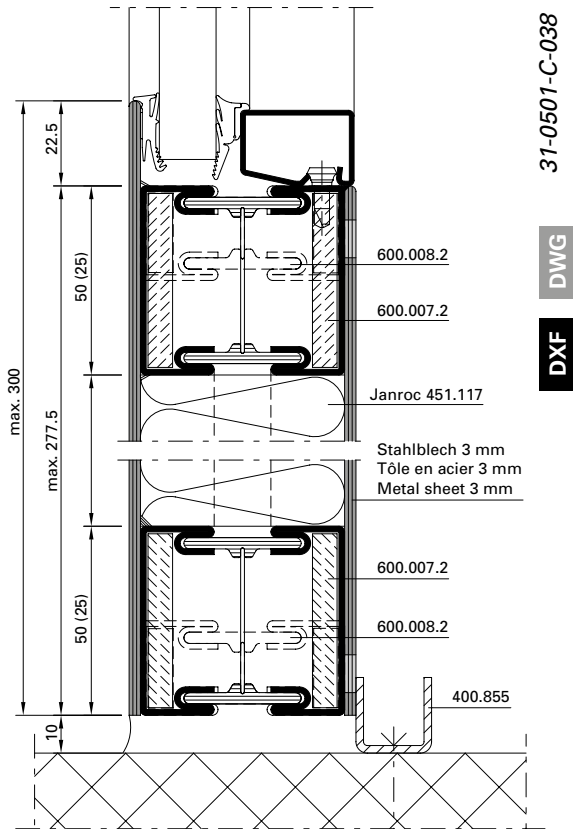

31-0501-C-038

DWG
 DXF

10.1

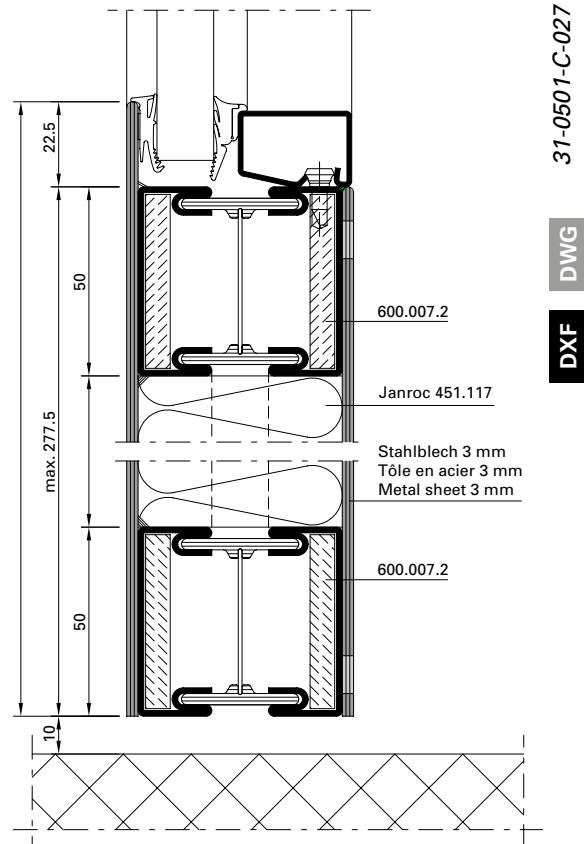

31-0501-C-027

DWG
 DXF

13.8

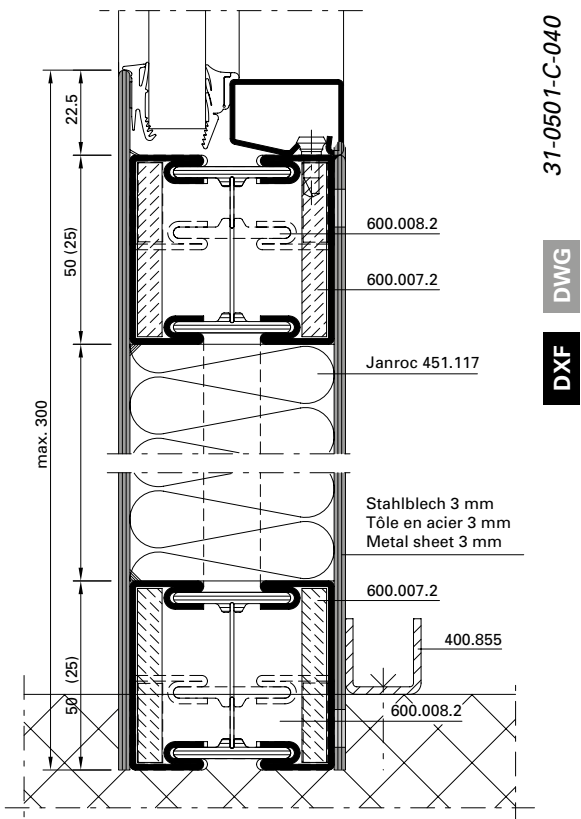

31-0501-C-040

DWG
 DXF

10.2

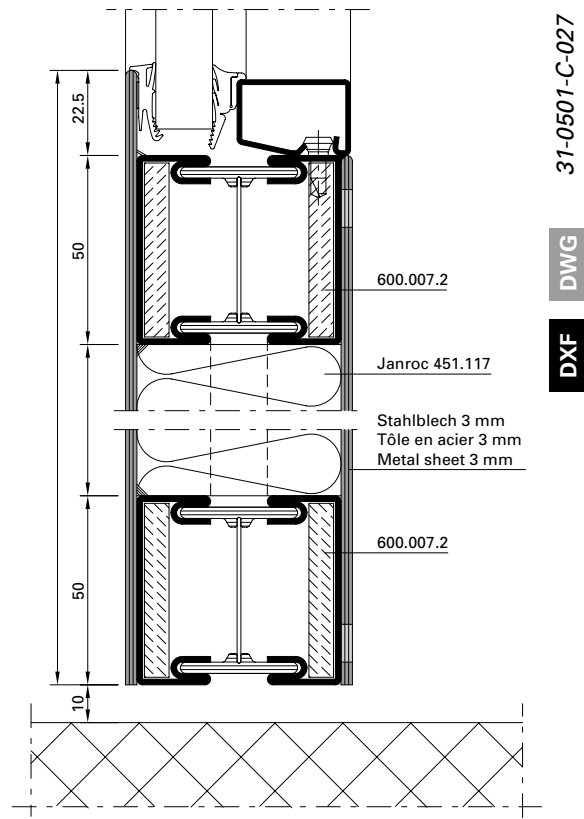

31-0501-C-027

DWG
 DXF

Schnittpunkte Schiebetüren im Massstab 1:2
Coupe de détails portes coulissantes à l'échelle 1:2
Section details sliding doors on scale 1:2

Brandschutzschiebetüre EI30
Porte coulissante coupe-feu EI30
Fire-resistant sliding door EI30

Variante Fingerschutz ≤ 8 mm

Variante anti-pince-doigts ≤ 8 mm

Version with anti-finger-trap
protection ≤ 8 mm

5.1

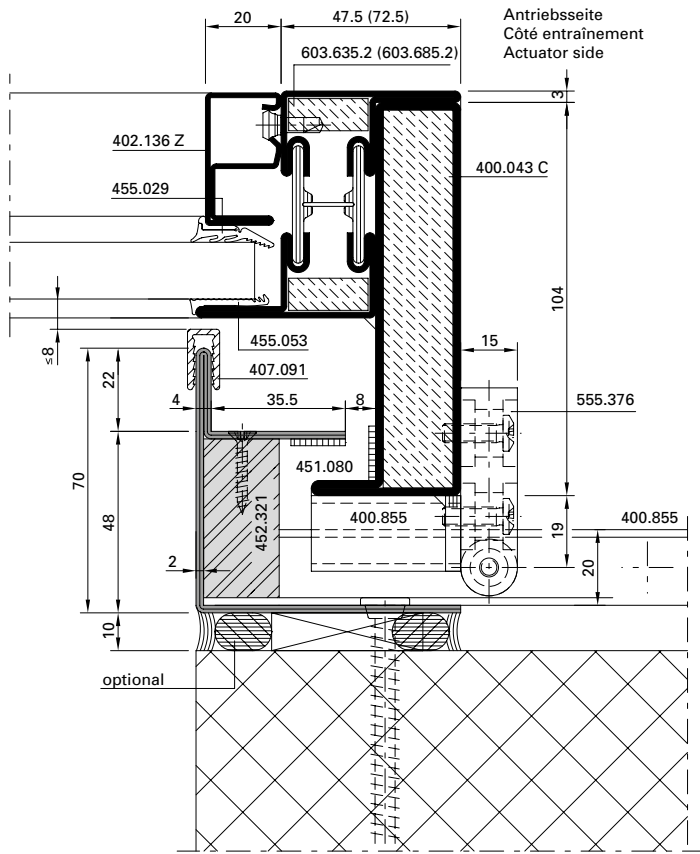

DXF

DWG

31-0501-C-006

Schiebetüren mit Break-Out Fluchttürfunktion

Portes coulissantes avec fonction porte de secours Break-Out

Sliding doors with Break-Out emergency exit function

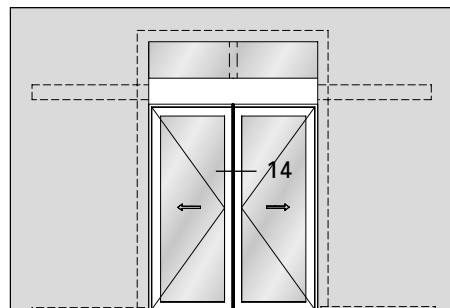
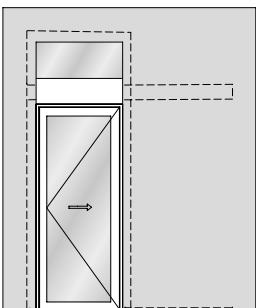
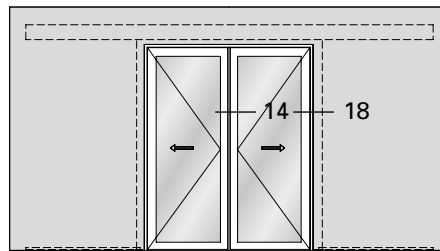
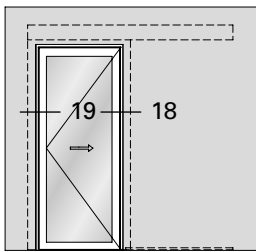
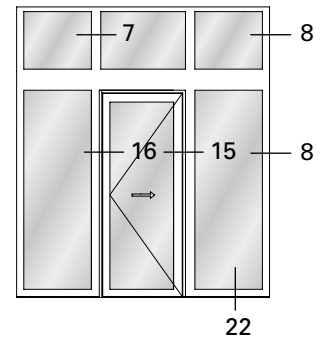
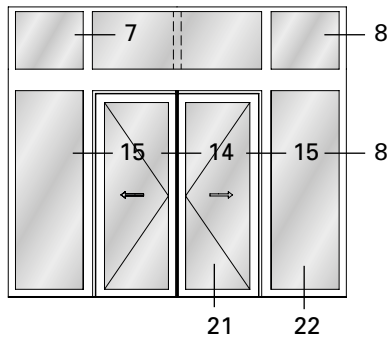
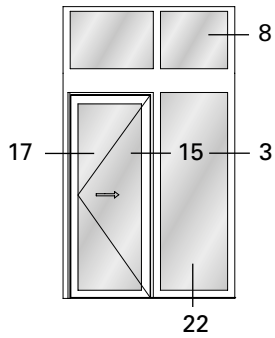
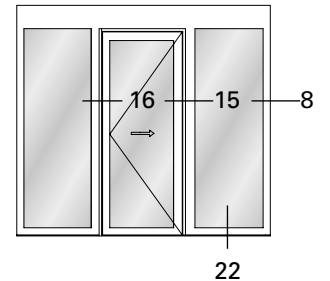
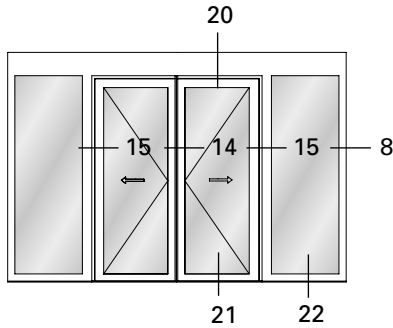
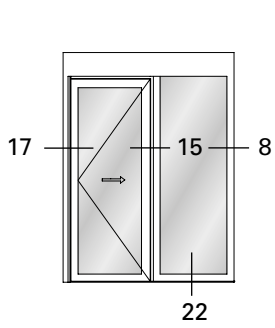

Variante mit Riegel
 Variante avec montant
 Version with mullion

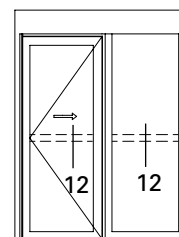

14.0

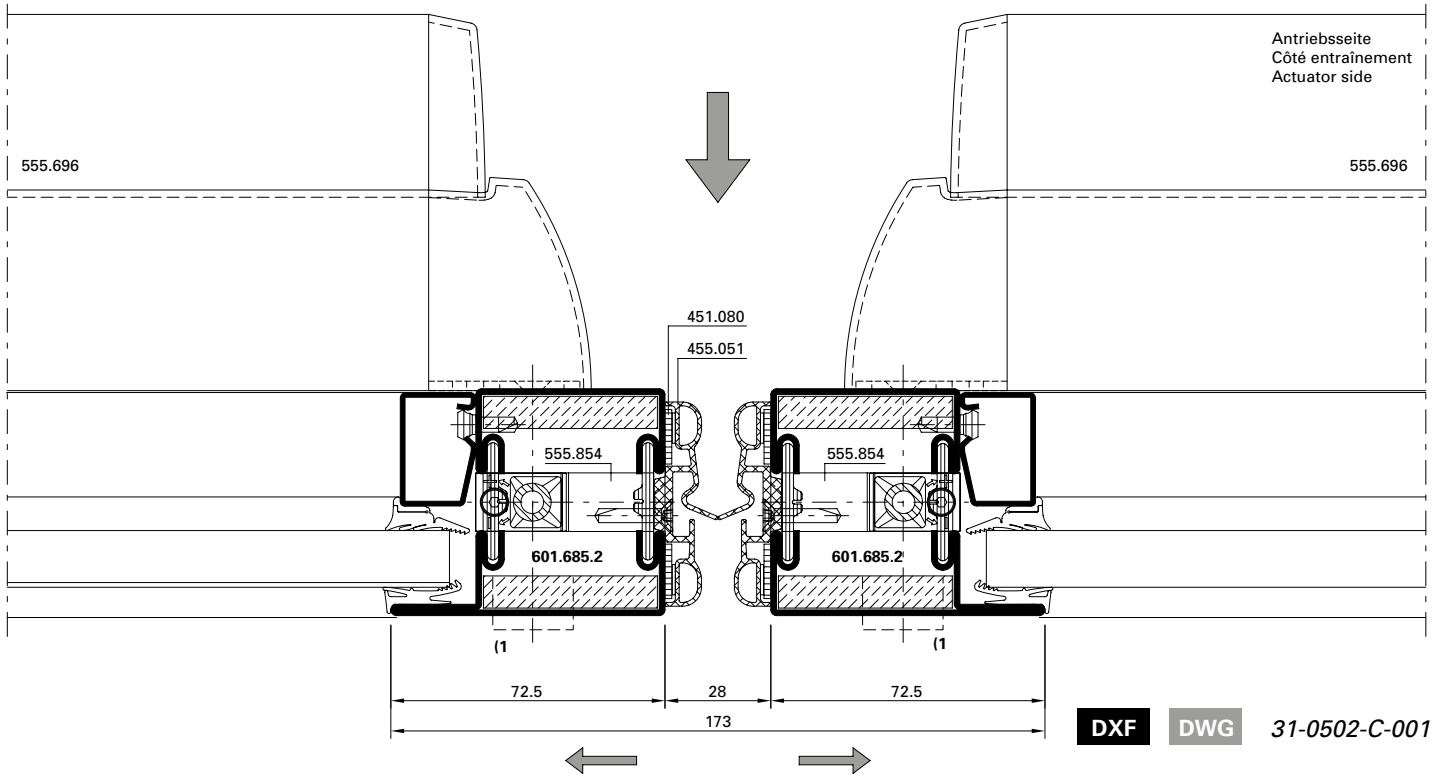

14.1

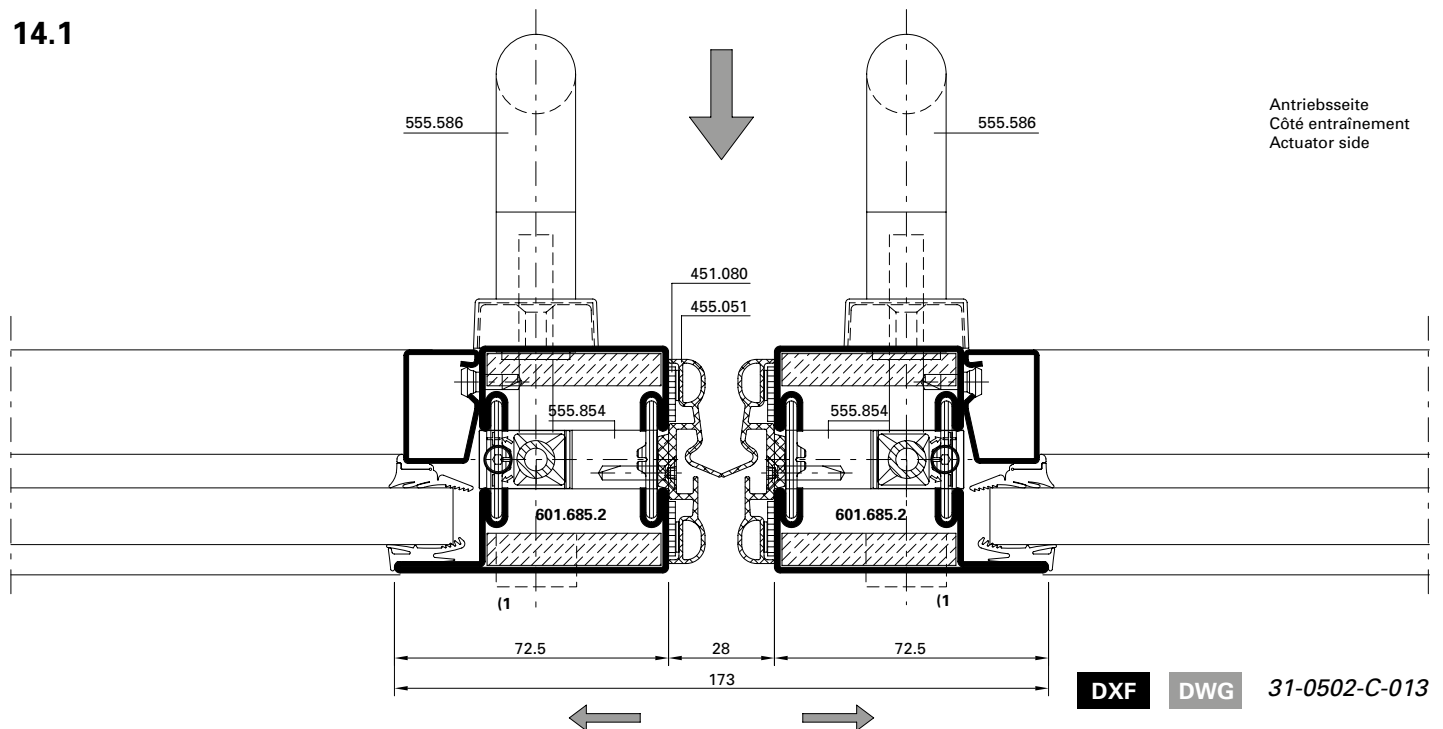

1) Zylinder optional (Interventions-
 Möglichkeit durch Feuerwehr)

1) Cylindre en option (possibilité
 d'intervention par les pompiers)

1) Cylinder optional (to allow
 intervention by the fire brigade)

Schnittpunkte Schiebetüren Break-Out im Massstab 1:2

Coupe de détails portes coulissantes à l'échelle 1:2

Section details sliding doors Break-Out on scale 1:2

Brandschutzschiebetüre EI30

Porte coulissante coupe-feu EI30

Fire-resistant sliding door EI30

15.0

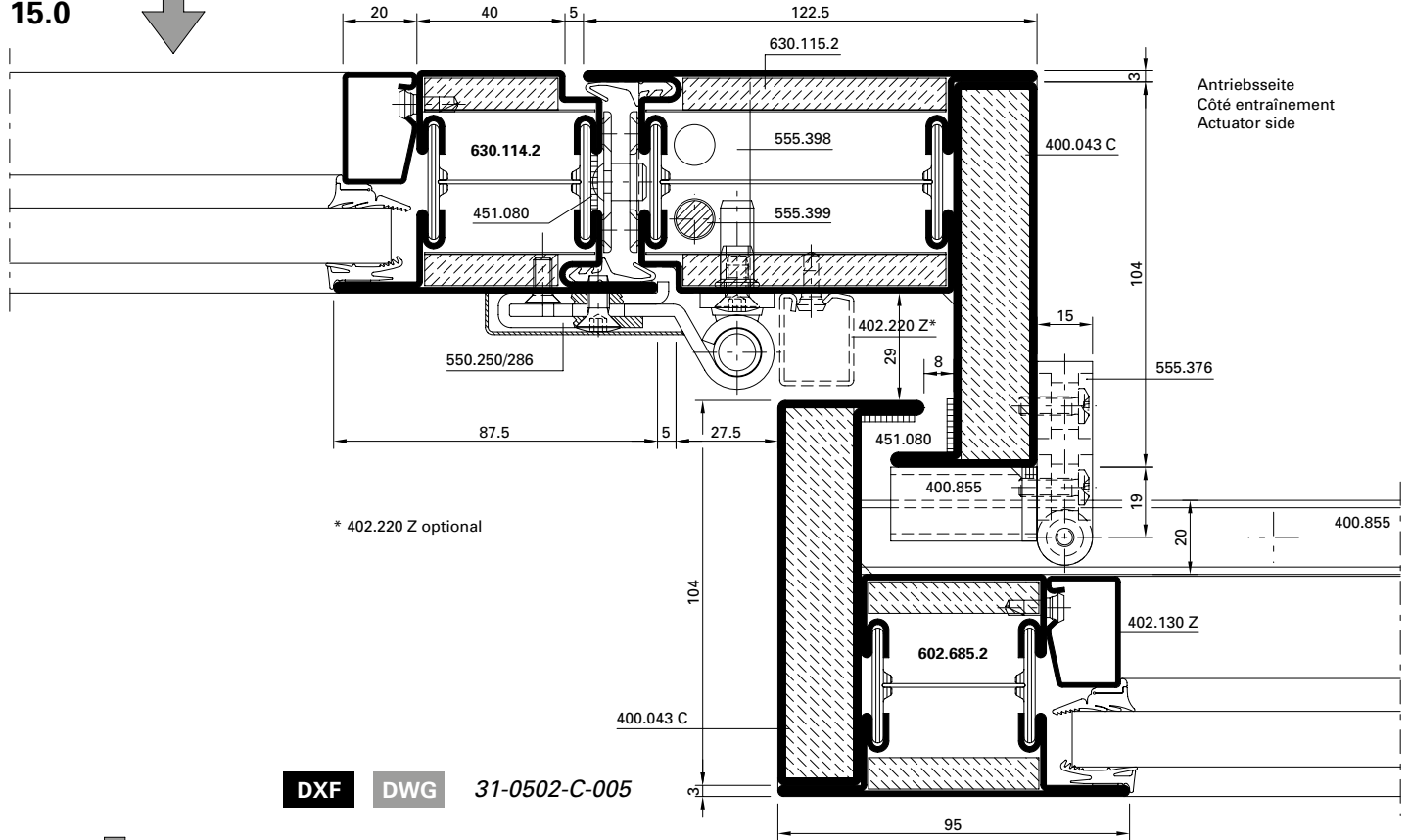
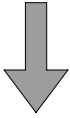

15.1

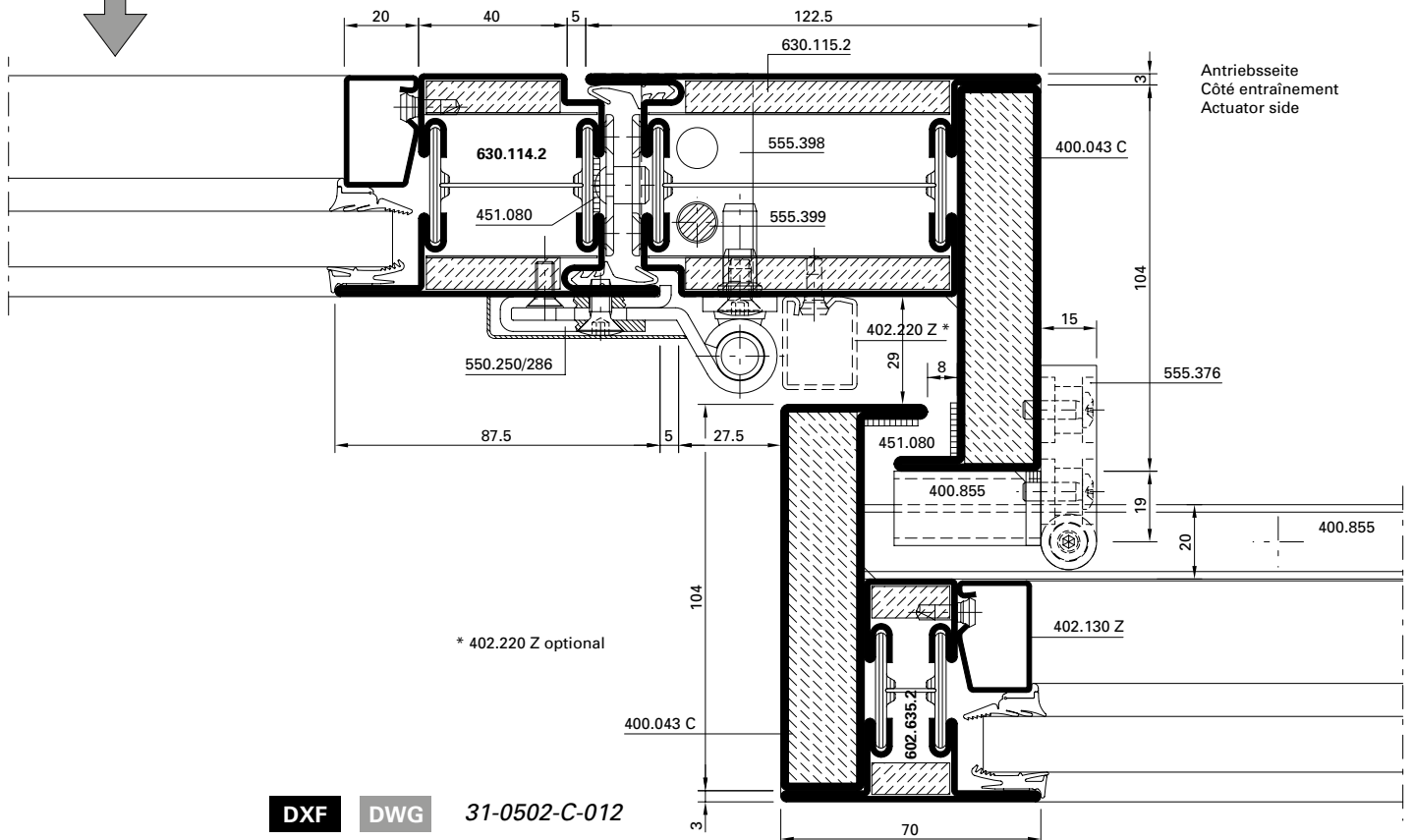
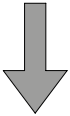

Schnittpunkte Schiebetüren Break-Out im Masstab 1:2

Coupe de détails portes coulissantes à l'échelle 1:2

Section details sliding doors Break-Out on scale 1:2

Brandschutzschiebetüre EI30

Porte coulissante coupe-feu EI30

Fire-resistant sliding door EI30

16.0

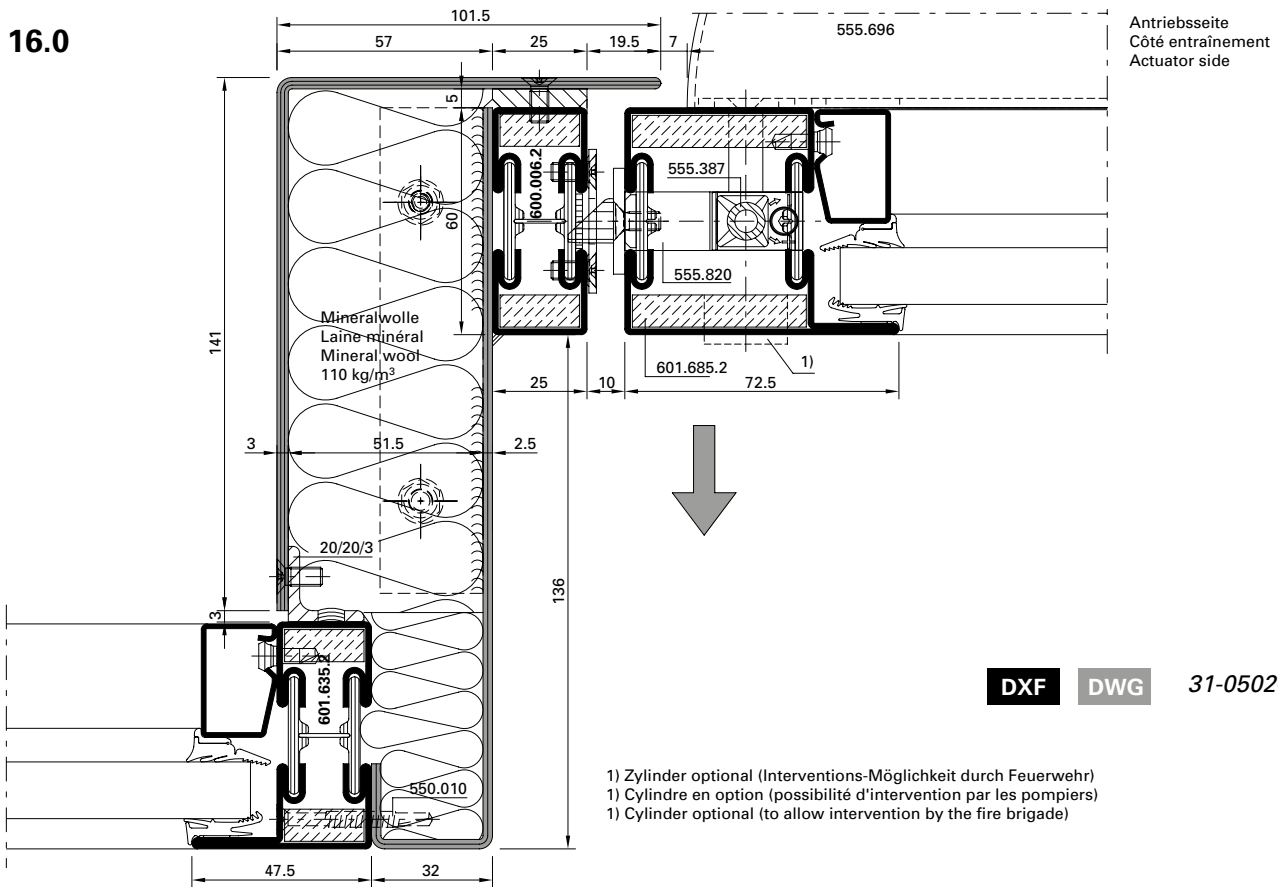

DXF

DWG

31-0502-C-002

- 1) Zylinder optional (Interventions-Möglichkeit durch Feuerwehr)
- 1) Cylindre en option (possibilité d'intervention par les pompiers)
- 1) Cylinder optional (to allow intervention by the fire brigade)

17.0

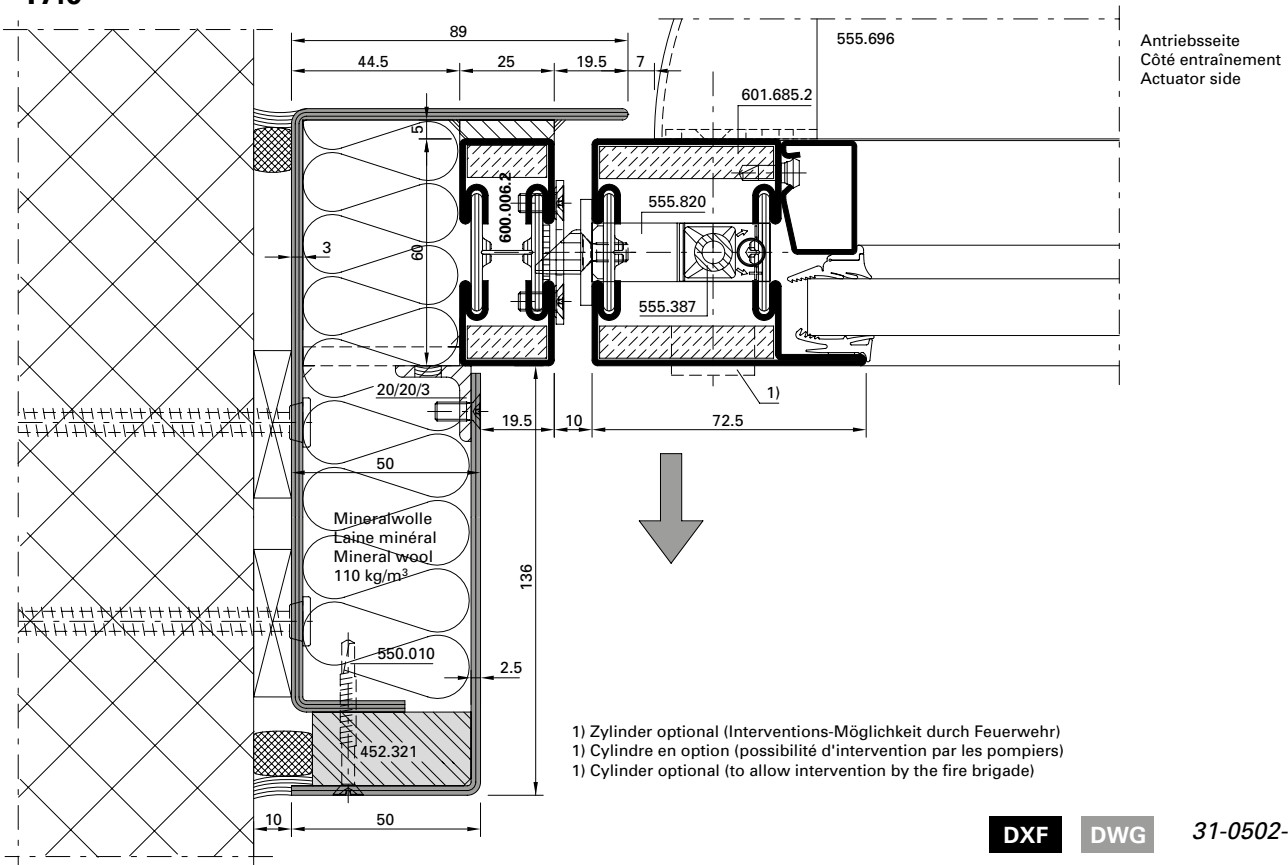

DXF

DWG

31-0502-C-003

Schnittpunkte Schiebetüren Break-Out im Massstab 1:2

Coupe de détails portes coulissantes à l'échelle 1:2

Section details sliding doors Break-Out on scale 1:2

Brandschutzschiebetüre EI30

Porte coulissante coupe-feu EI30

Fire-resistant sliding door EI30

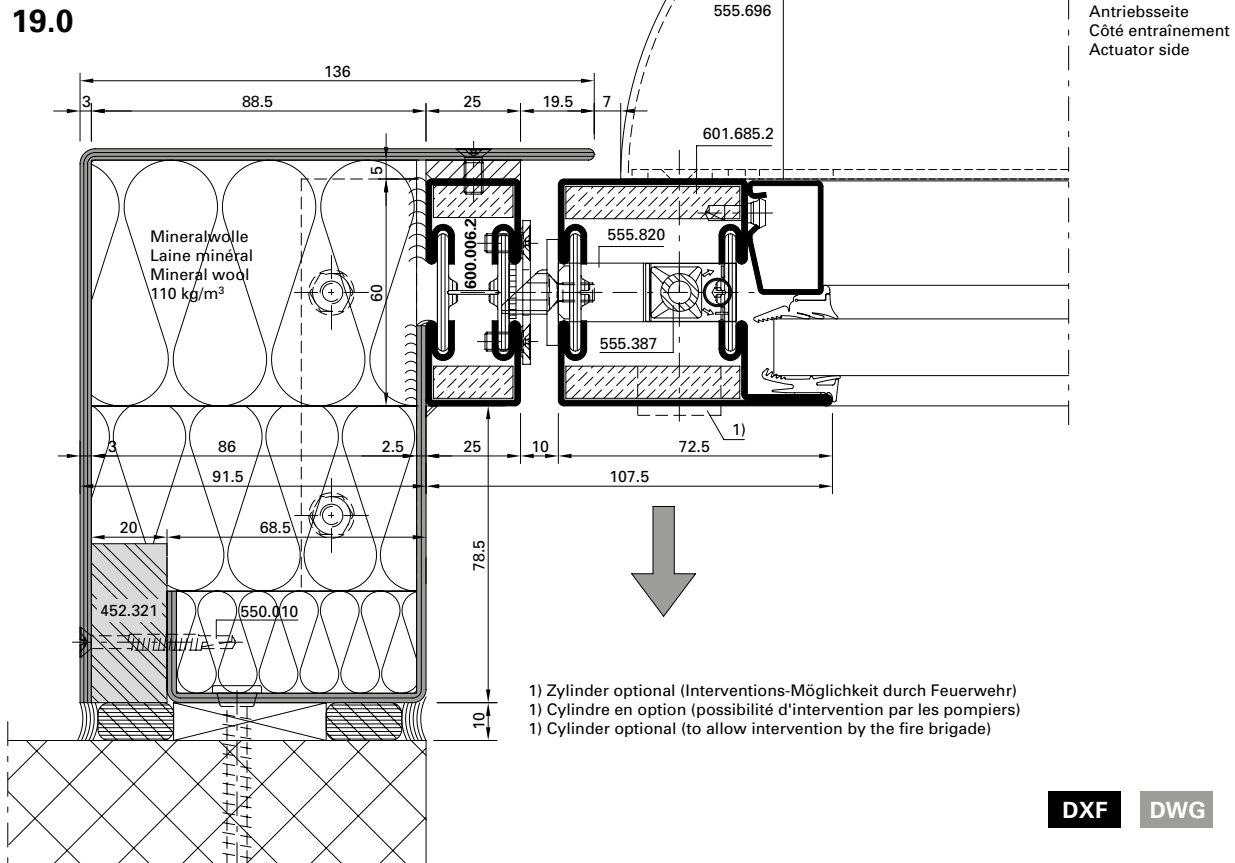
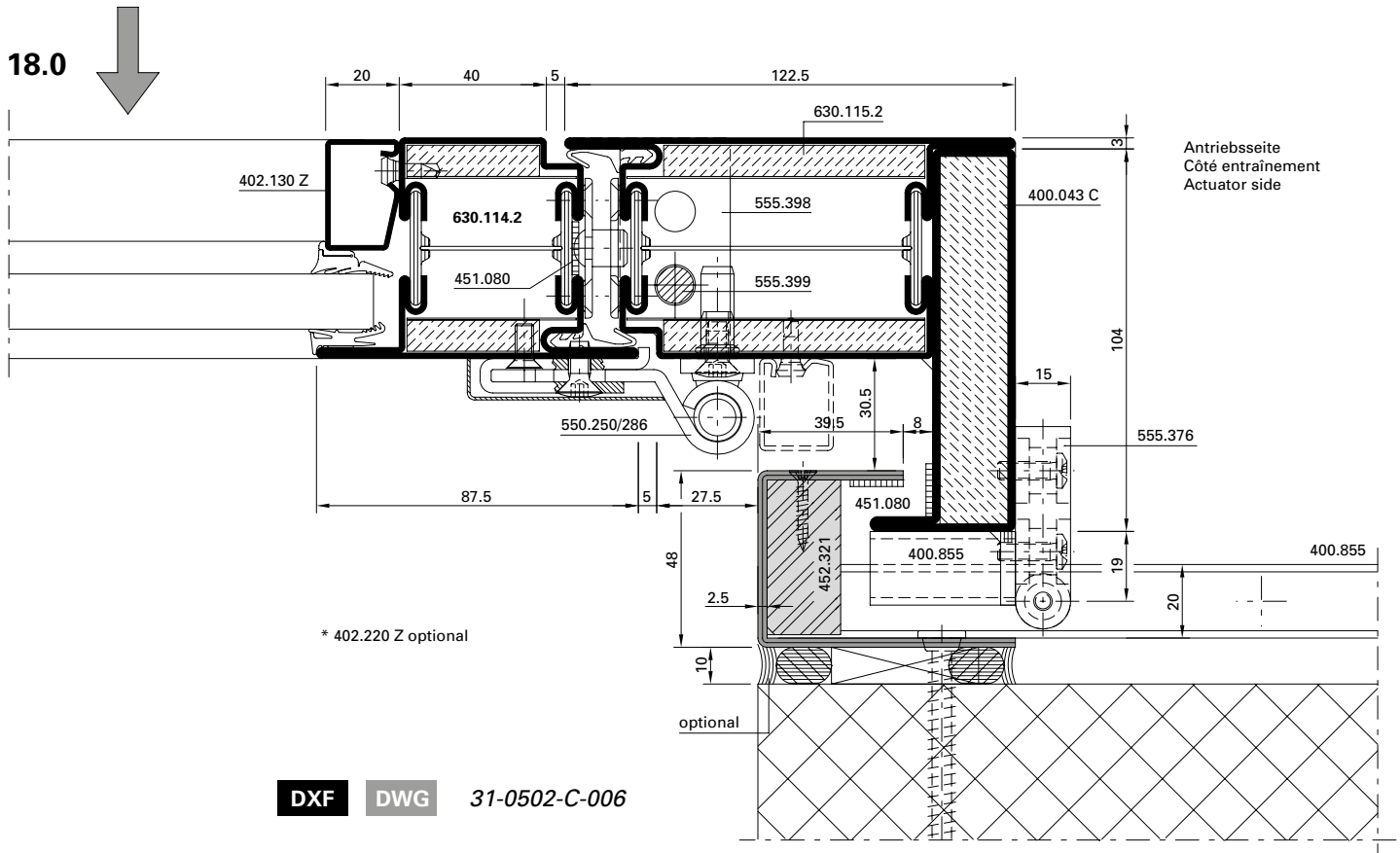

20.0

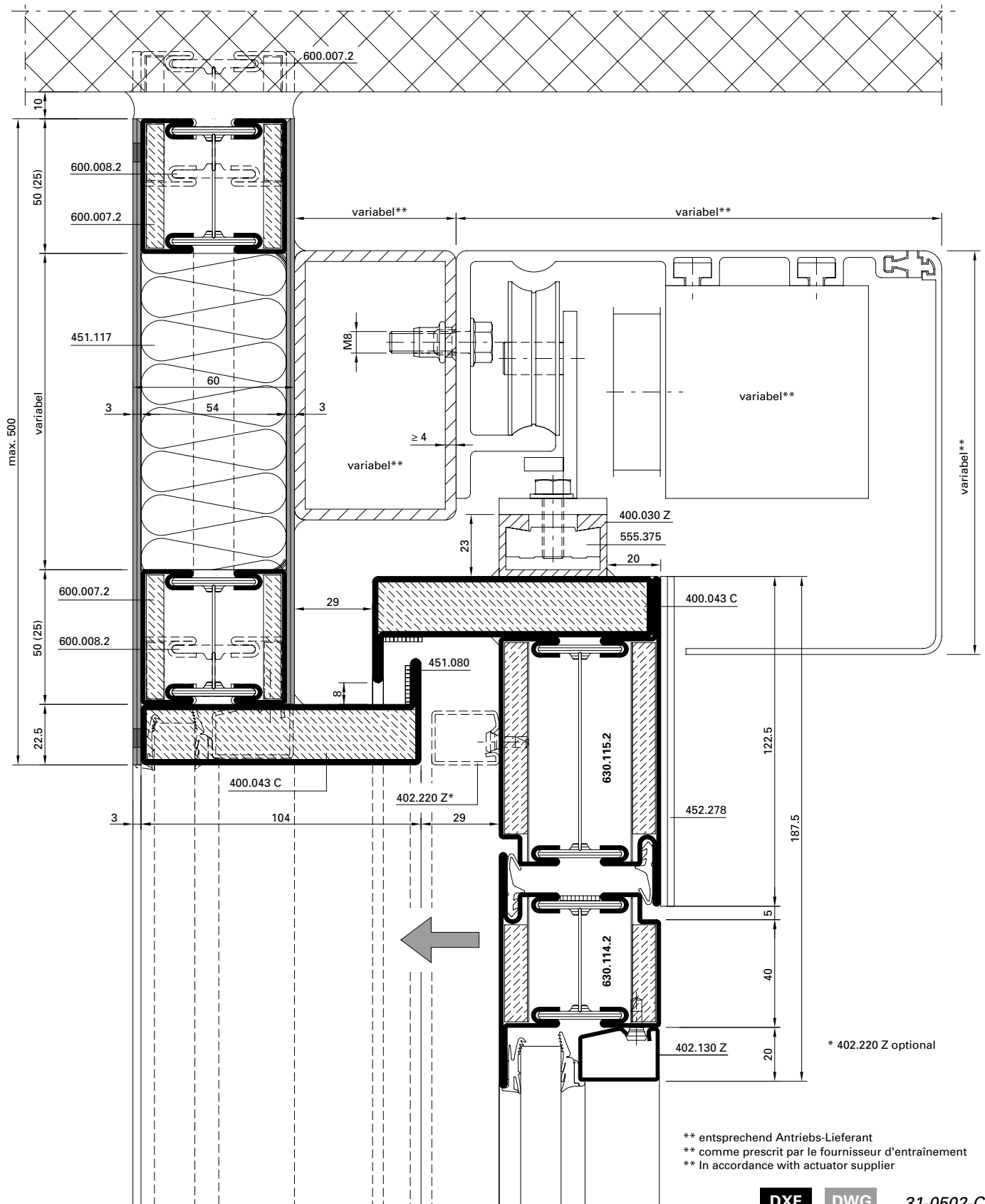

Schnittpunkte Schiebetüren Break-Out im Masstab 1:2
Coupe de détails portes coulissantes à l'échelle 1:2
Section details sliding doors Break-Out on scale 1:2

Brandschutzschiebetüre EI30
Porte coulissante coupe-feu EI30
Fire-resistant sliding door EI30

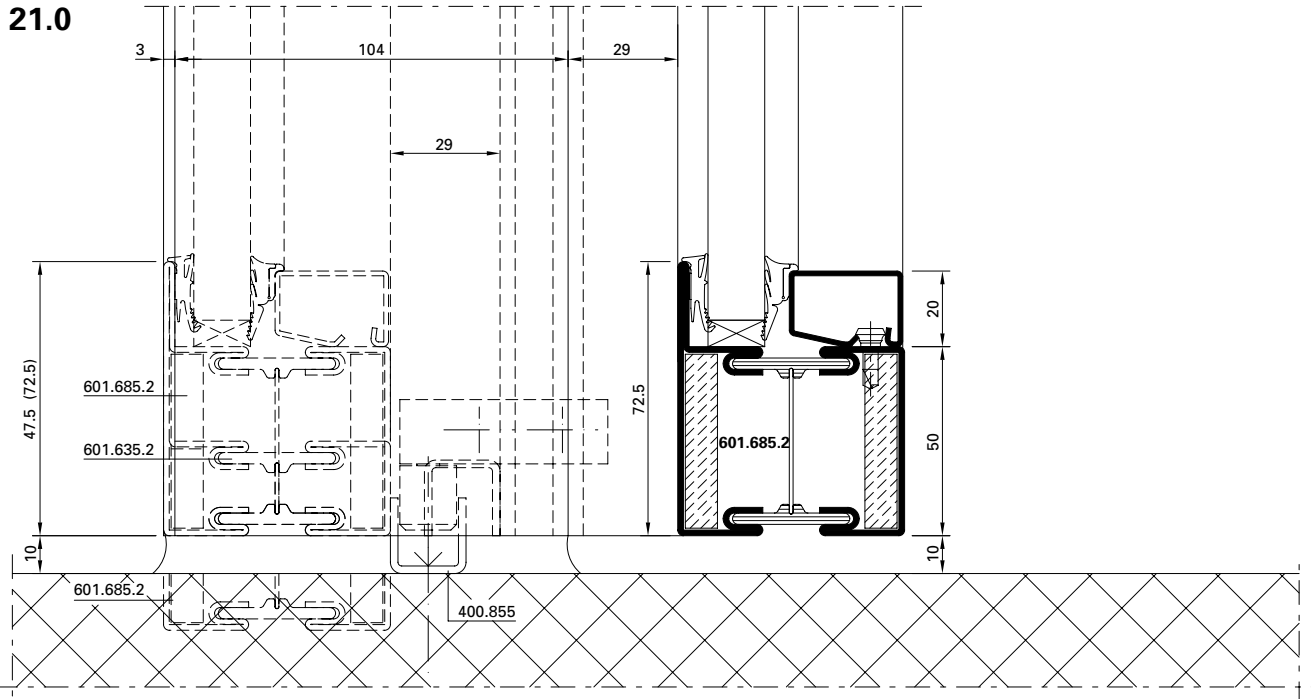

DXF

DWG

31-0502-C-008

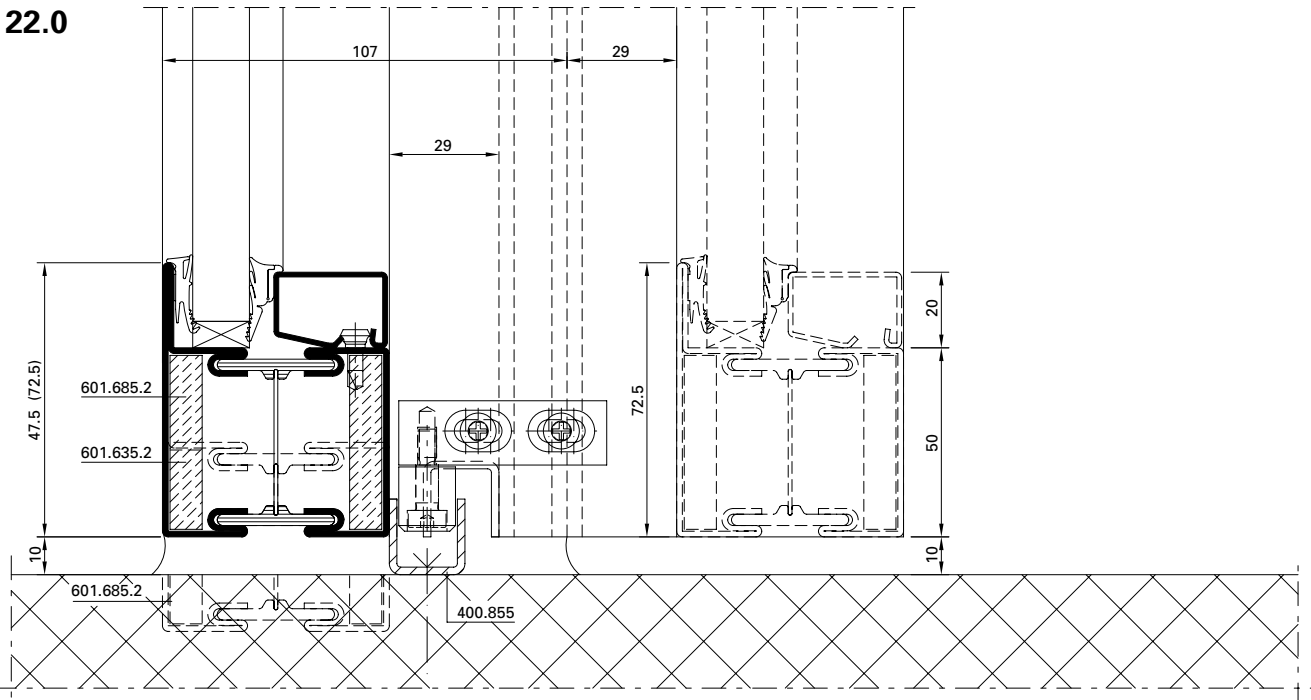

DXF

DWG

31-0502-C-009

15.2

Bolzen um 18 mm kürzen
Raccourcir le boulon de 18 mm
Shorten the pin by 18 mm

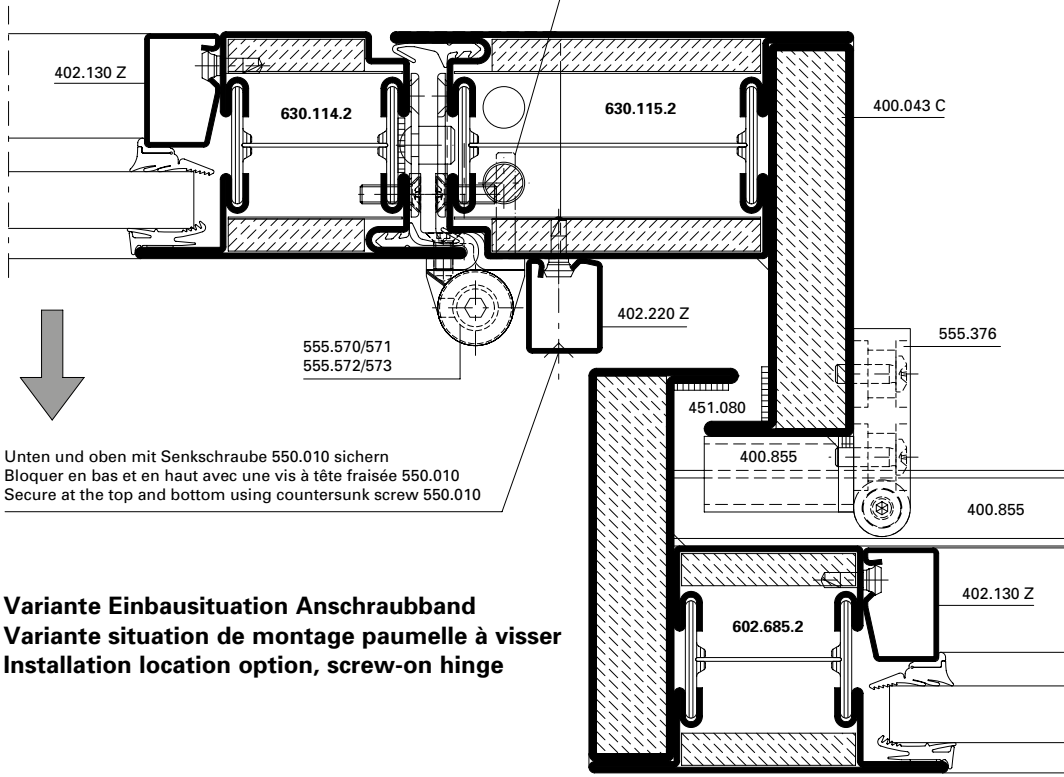

Variante Einbausituation Anschraubband
Variante situation de montage paumelle à visser
Installation location option, screw-on hinge

DXF DWG

31-0502-C-010

15.3

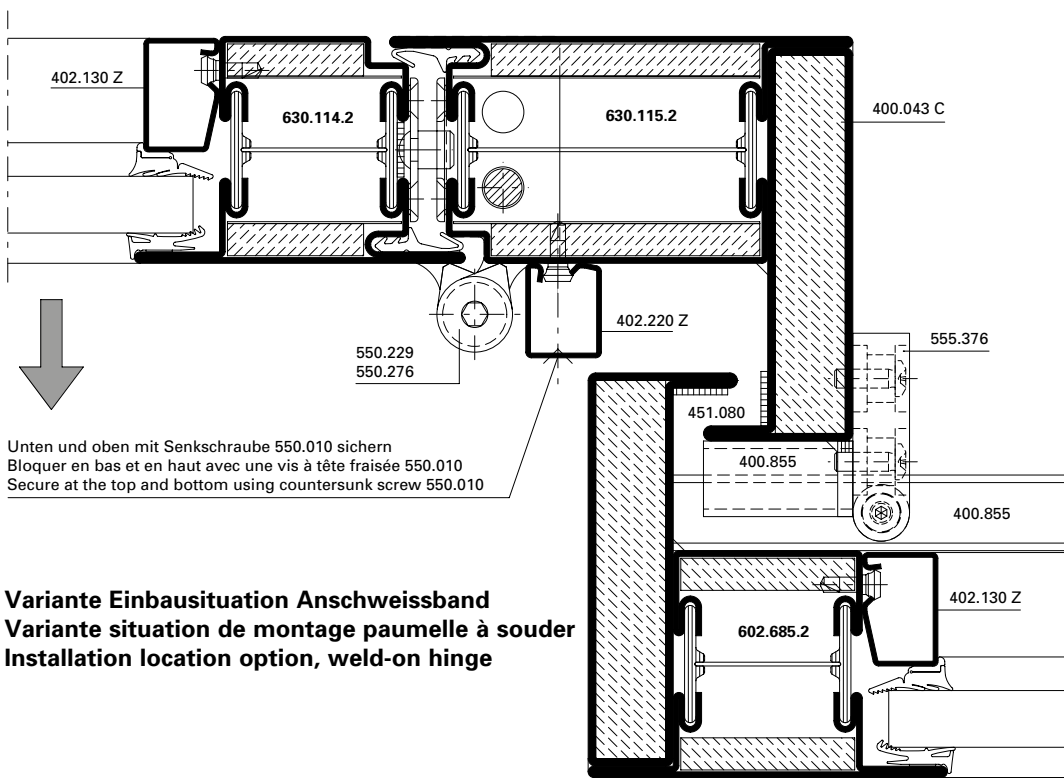

Variante Einbausituation Anschweisband
Variante situation de montage paumelle à souder
Installation location option, weld-on hinge

DXF DWG

31-0502-C-011

Schnittpunkte Schiebetüren Break-In
Coupe de détails portes coulissantes Break-In
Section details sliding doors Break-In

Brandschutzschiebetüre EI30
Porte coulissante coupe-feu EI30
Fire-resistant sliding door EI30

Schiebetüren mit Break-In Fluchttürfunktion

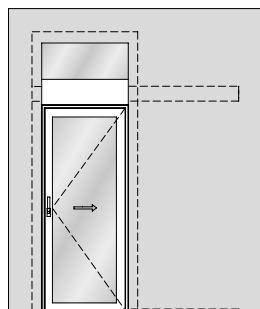
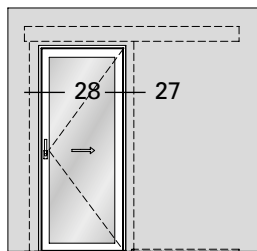
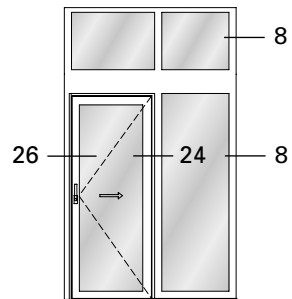
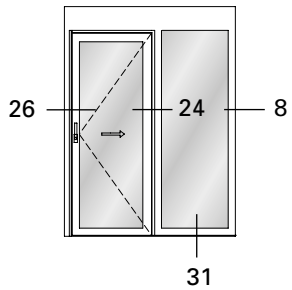

Portes coulissantes avec fonction porte de secours Break-In

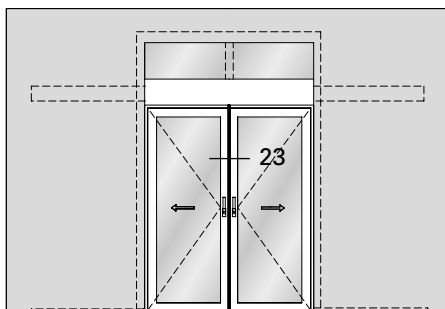
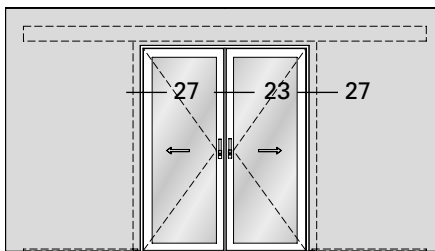
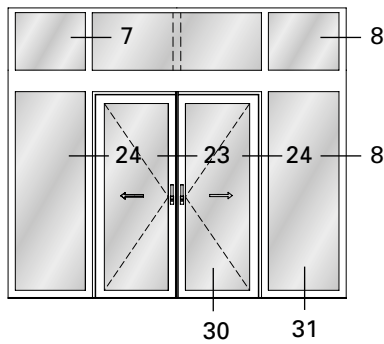
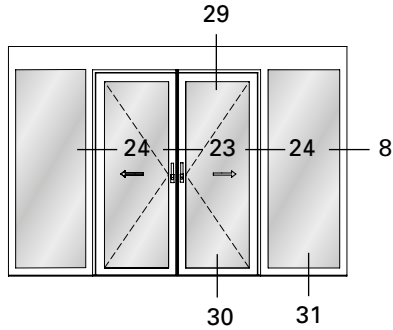

Sliding doors with Break-In emergency exit function

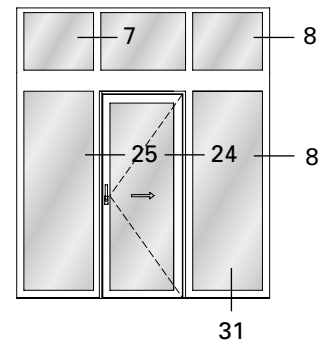
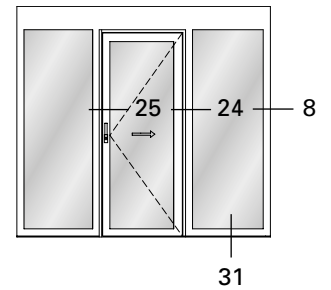

Variante mit Riegel
Variante avec montant
Version with mullion

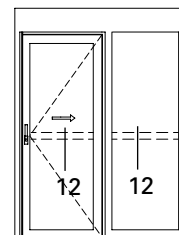

23.0

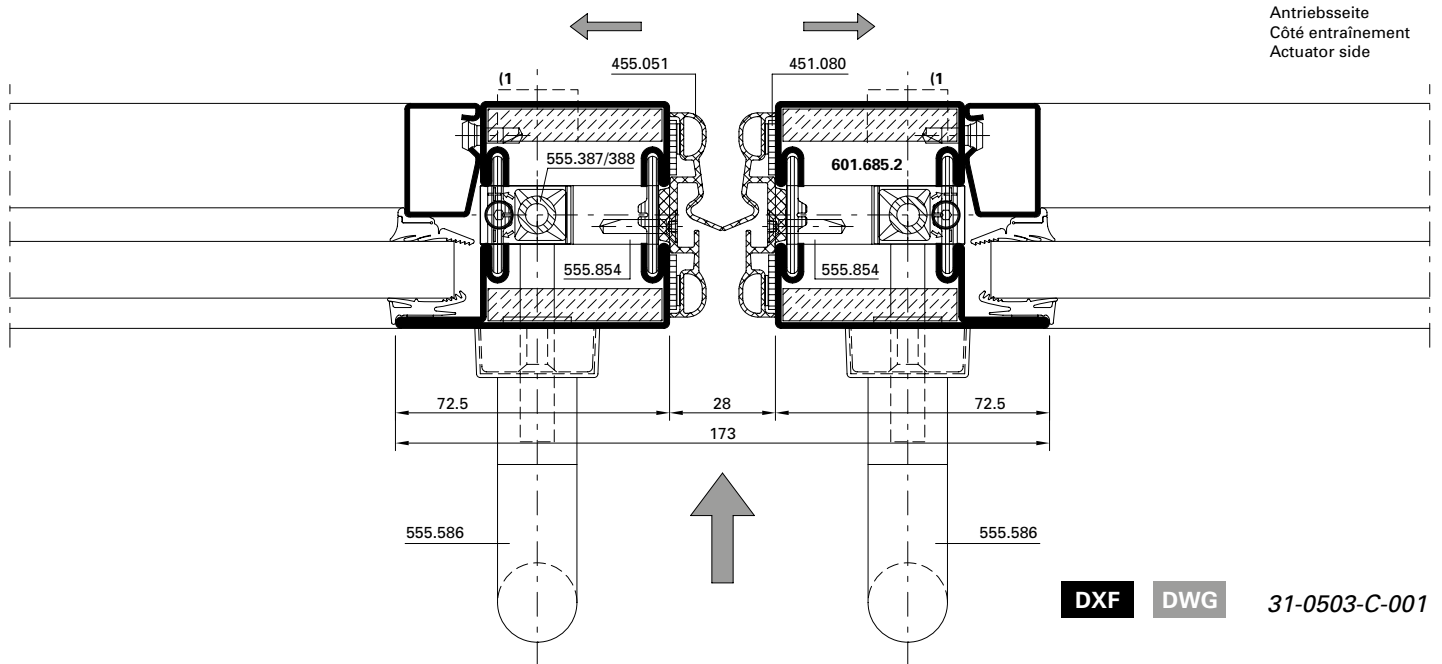

23.1

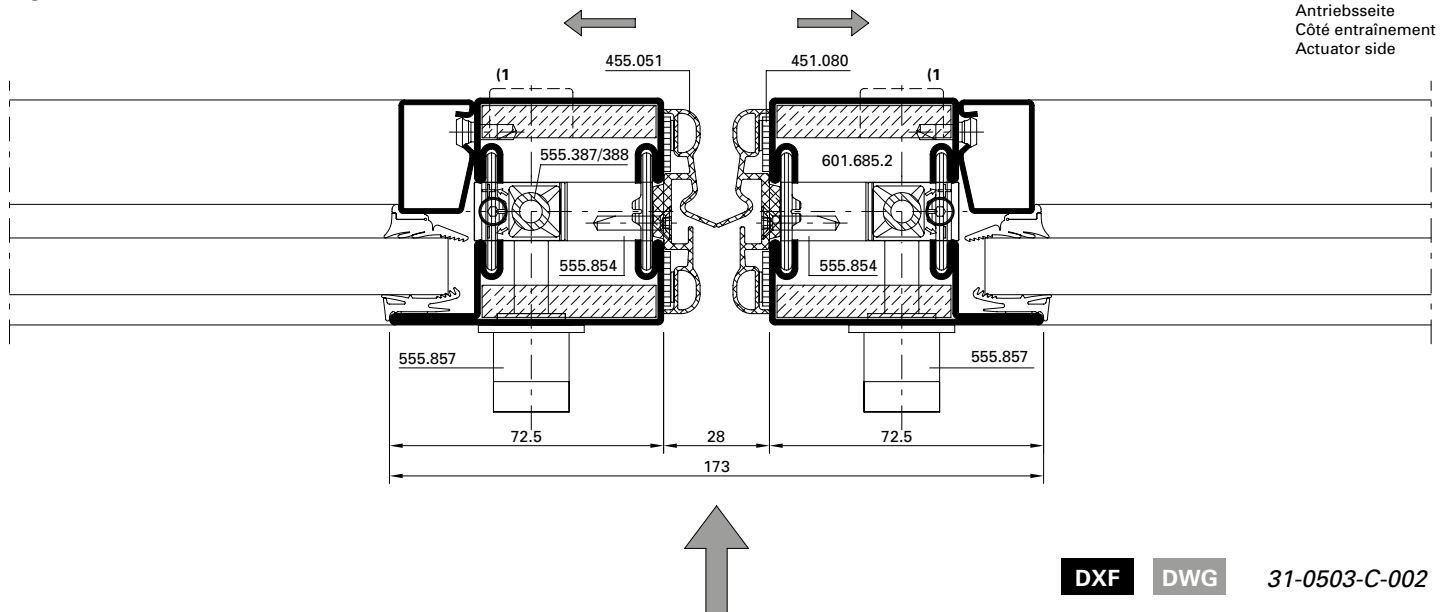

1) Zylinder optional (Interventions
 Möglichkeit durch Feuerwehr)

1) Cylindre en option (possibilité
 d'intervention par les pompiers)

1) Cylinder optional (to allow
 intervention by the fire brigade)

Schnittpunkte Schiebetüren Break-In im Masstab 1:2
Coupe de détails portes coulissantes Break-In à l'échelle 1:2
Section details sliding doors Break-In on scale 1:2

Brandschutzschiebetüre EI30
Porte coulissante coupe-feu EI30
Fire-resistant sliding door EI30

24.0

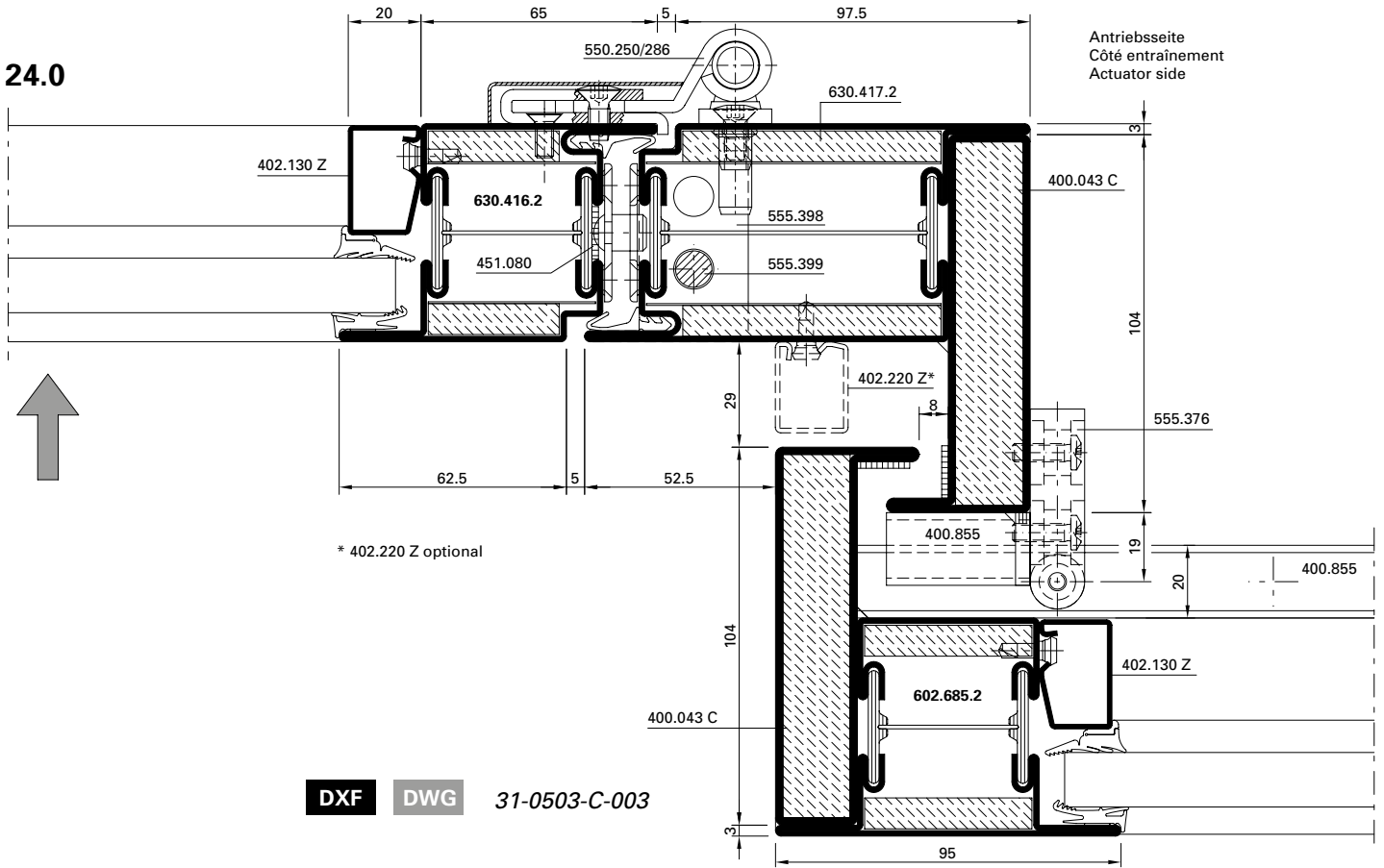

DXF DWG 31-0503-C-003

24.1

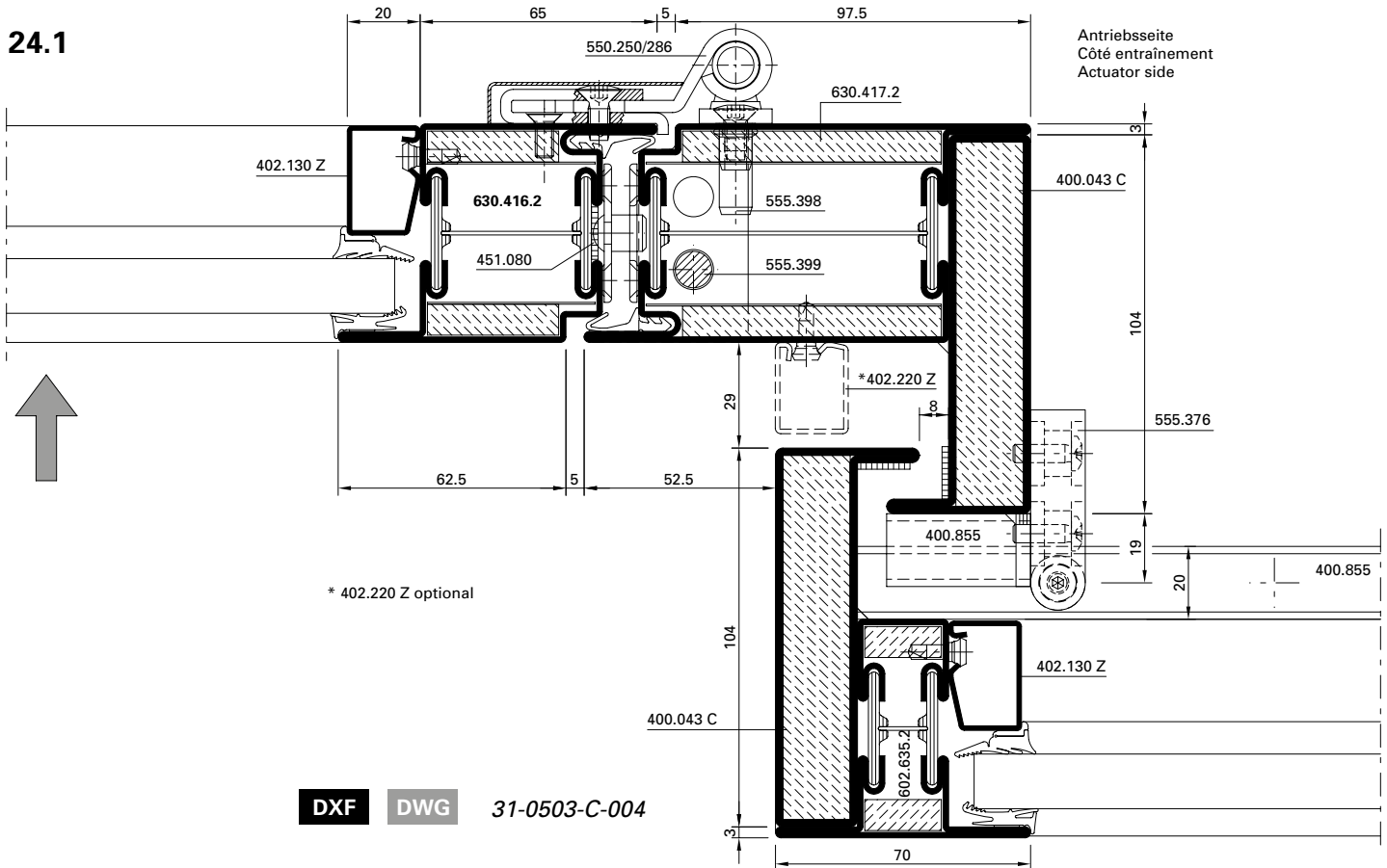

DXF DWG 31-0503-C-004

Schnittpunkte Schiebetüren Break-In im Masstab 1:2
Coupe de détails portes coulissantes Break-In à l'échelle 1:2
Section details sliding doors Break-In on scale 1:2

Brandschutzschiebetüre EI30
Porte coulissante coupe-feu EI30
Fire-resistant sliding door EI30

25.0

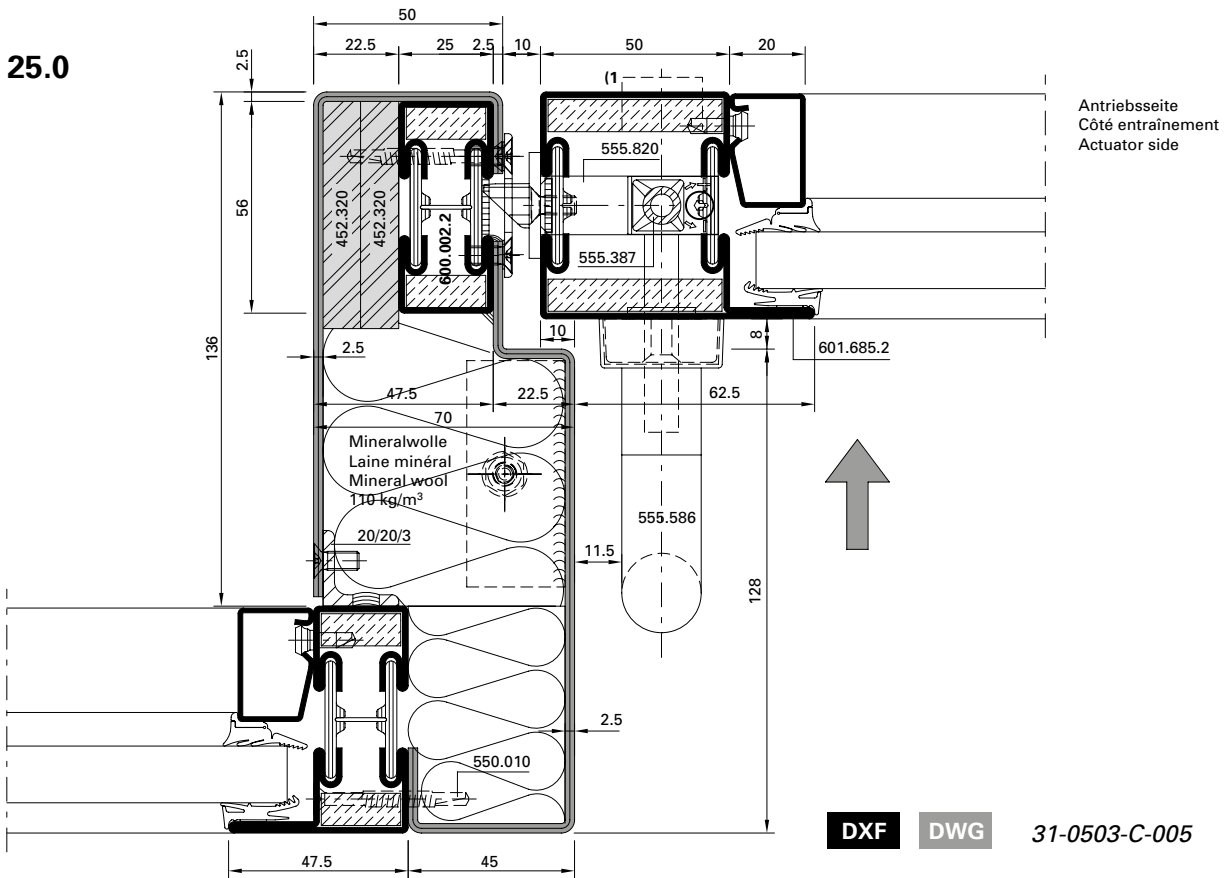

26.0

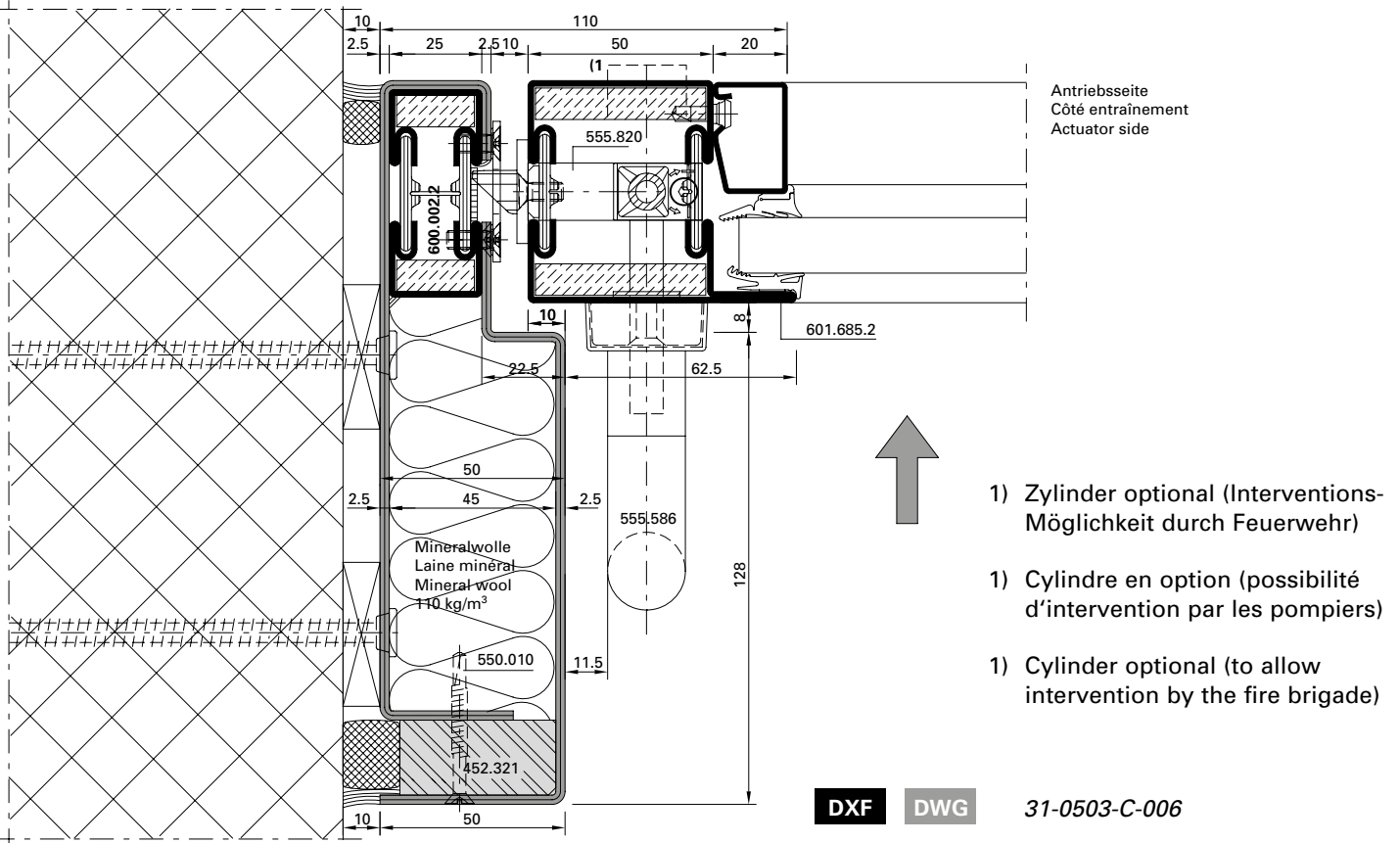

- 1) Zylinder optional (Interventions-Möglichkeit durch Feuerwehr)
- 1) Cylindre en option (possibilité d'intervention par les pompiers)
- 1) Cylinder optional (to allow intervention by the fire brigade)

Schnittpunkte Schiebetüren Break-In im Masstab 1:2
Coupe de détails portes coulissantes Break-In à l'échelle 1:2
Section details sliding doors Break-In on scale 1:2

Brandschutzschiebetüre EI30
Porte coulissante coupe-feu EI30
Fire-resistant sliding door EI30

27.0

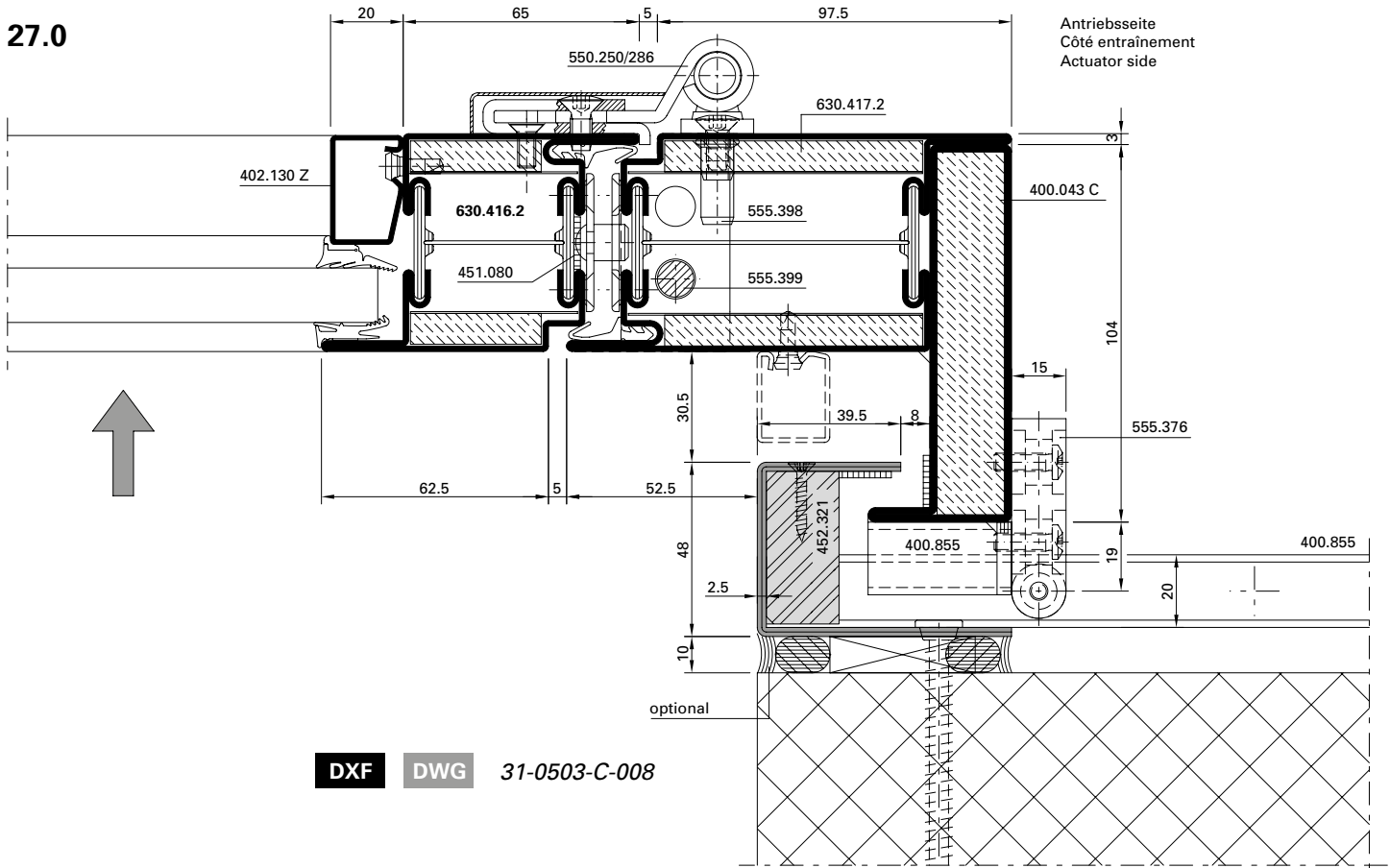

28.0

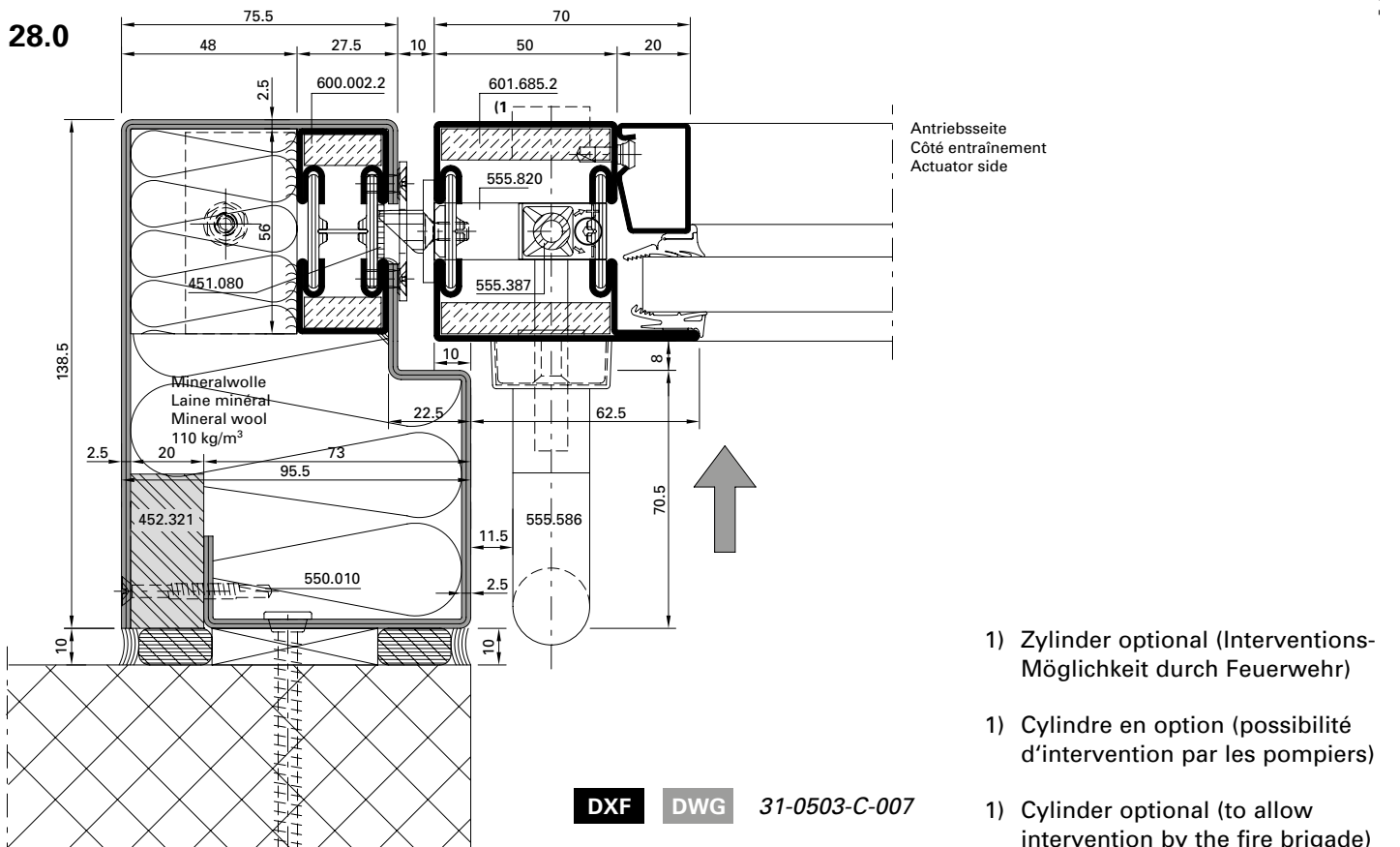

- 1) Zylinder optional (Interventions-Möglichkeit durch Feuerwehr)
- 1) Cylindre en option (possibilité d'intervention par les pompiers)
- 1) Cylinder optional (to allow intervention by the fire brigade)

29.0

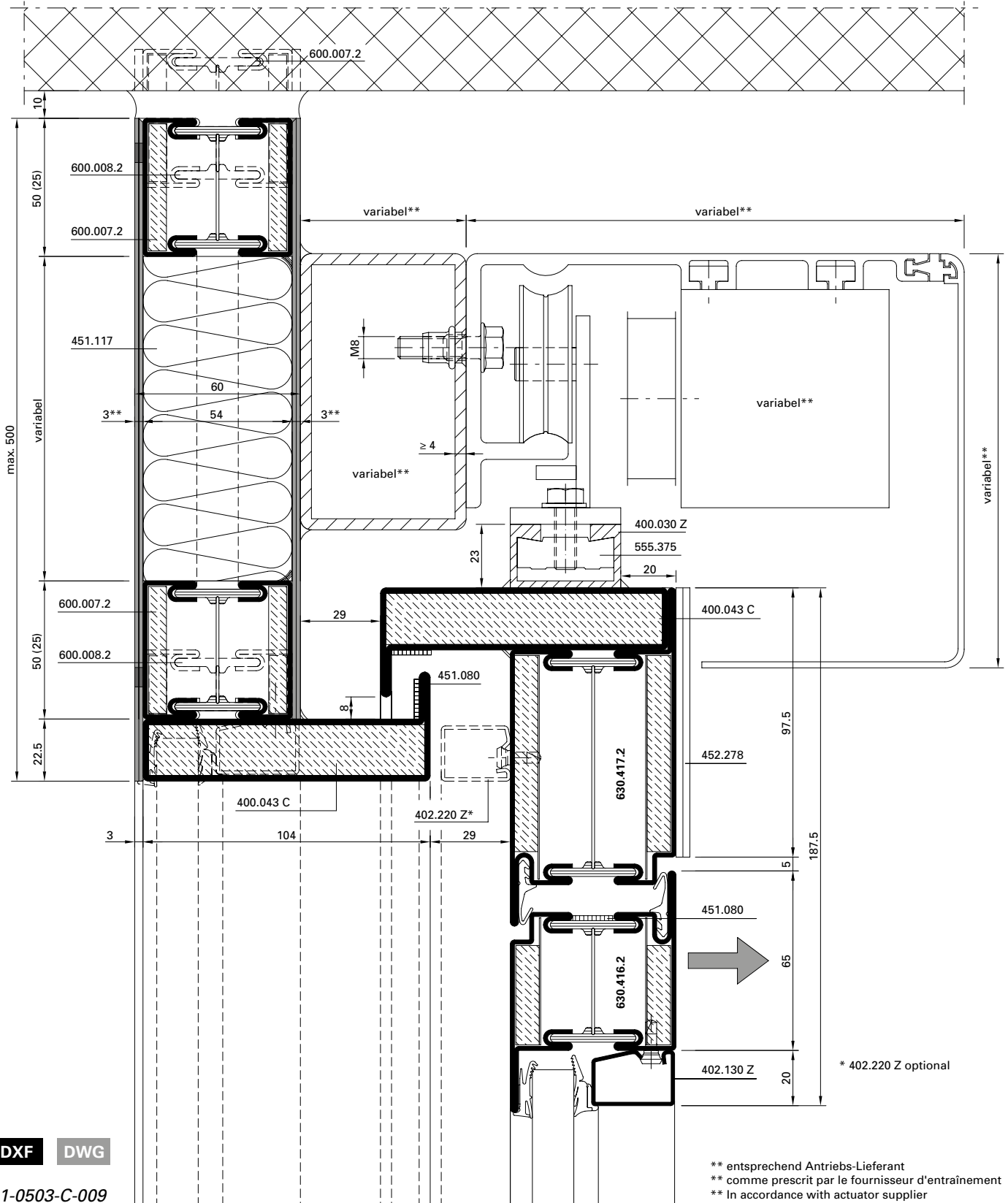

DXF DWG

31-0503-C-009

Schnittpunkte Schiebetüren Break-In im Masstab 1:2
Coupe de détails portes coulissantes Break-In à l'échelle 1:2
Section details sliding doors Break-In on scale 1:2

Brandschutzschiebetüre EI30
Porte coulissante coupe-feu EI30
Fire-resistant sliding door EI30

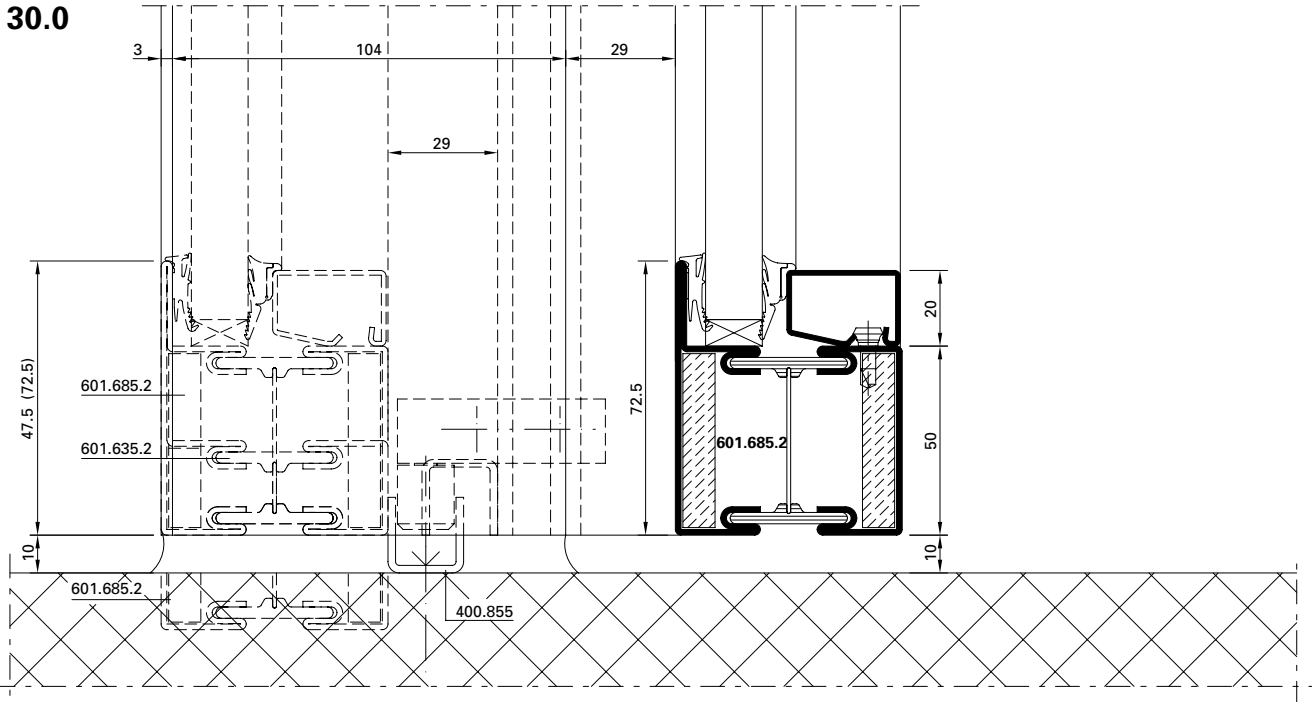

DXF **DWG** 31-0502-C-008

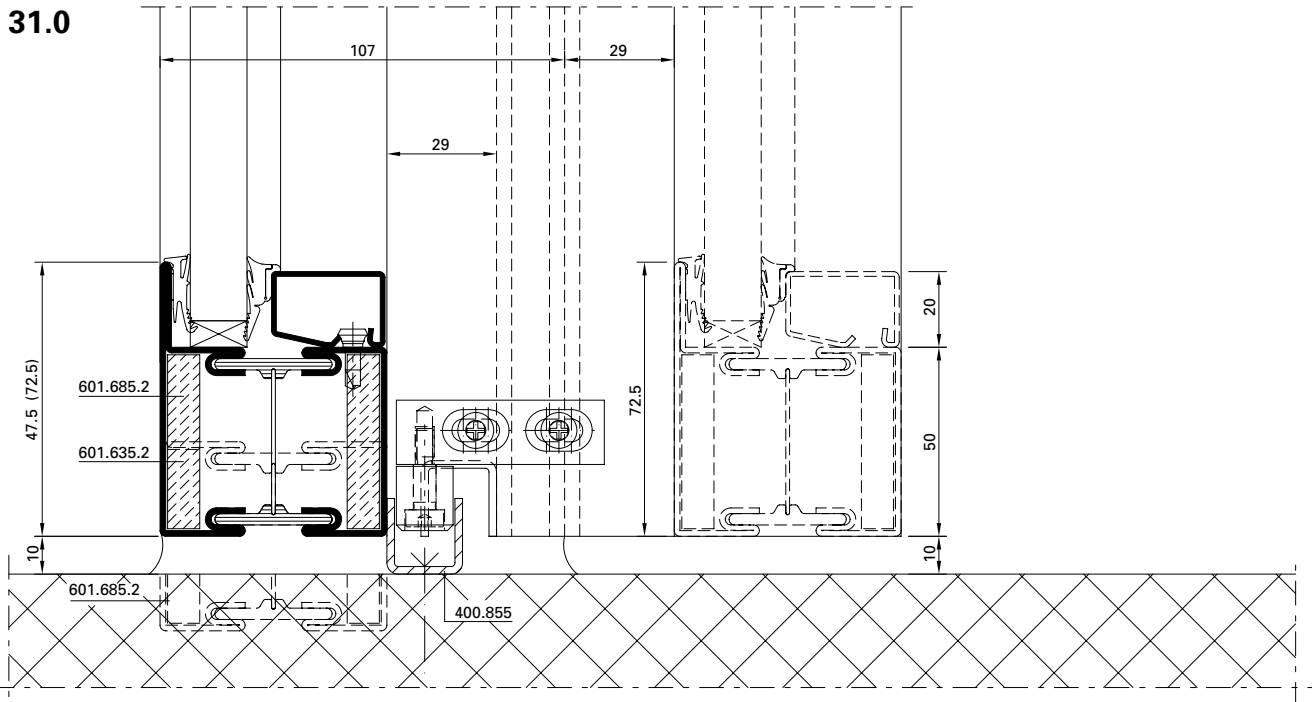

DXF **DWG** 31-0502-C-009

Schnittpunkte Schiebetüren Break-In im Masstab 1:2
Coupe de détails portes coulissantes Break-In à l'échelle 1:2
Section details sliding doors Break-In on scale 1:2

Brandschutzschiebetüre EI30
Porte coulissante coupe-feu EI30
Fire-resistant sliding door EI30

Schiebetüren mit Break-In Fluchttürfunktion Variante Einlassgriff

Portes coulissantes avec fonction porte de secours Break-In Variante poignée enchâssée

Sliding doors with Break-In emergency exit function Recessed handle option

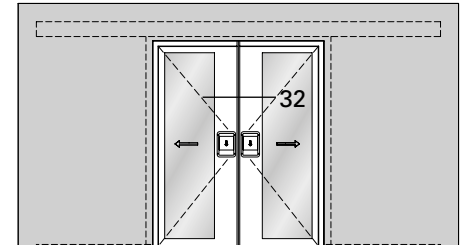
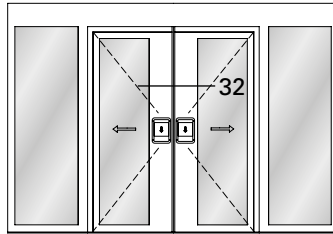
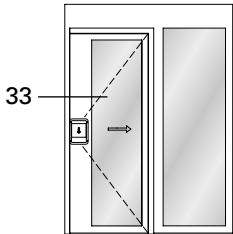

32.0

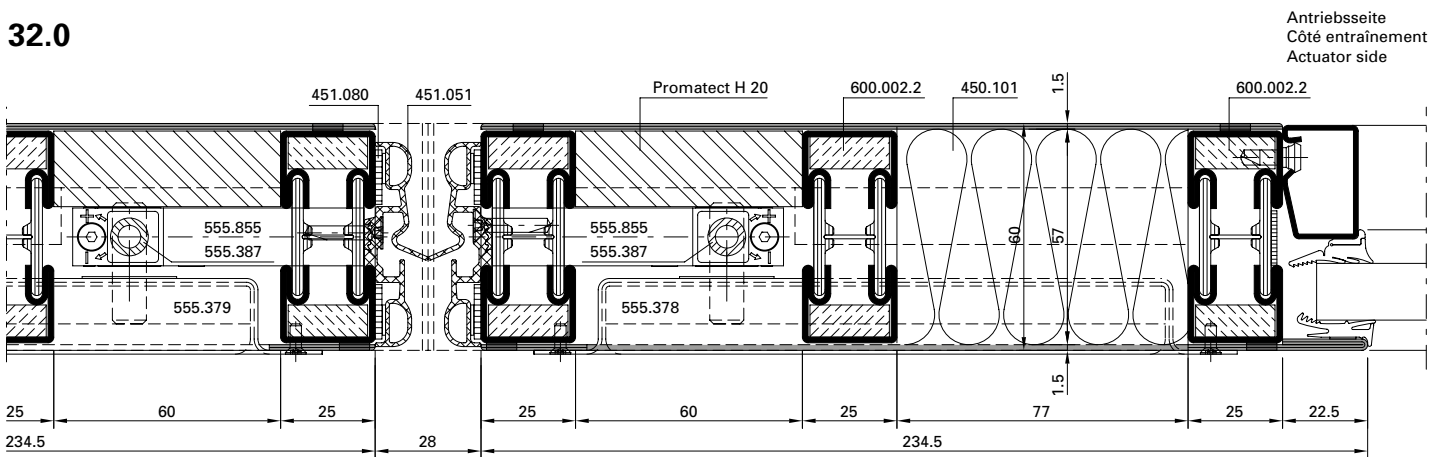

DXF DWG 31-0503-C-010

33.0

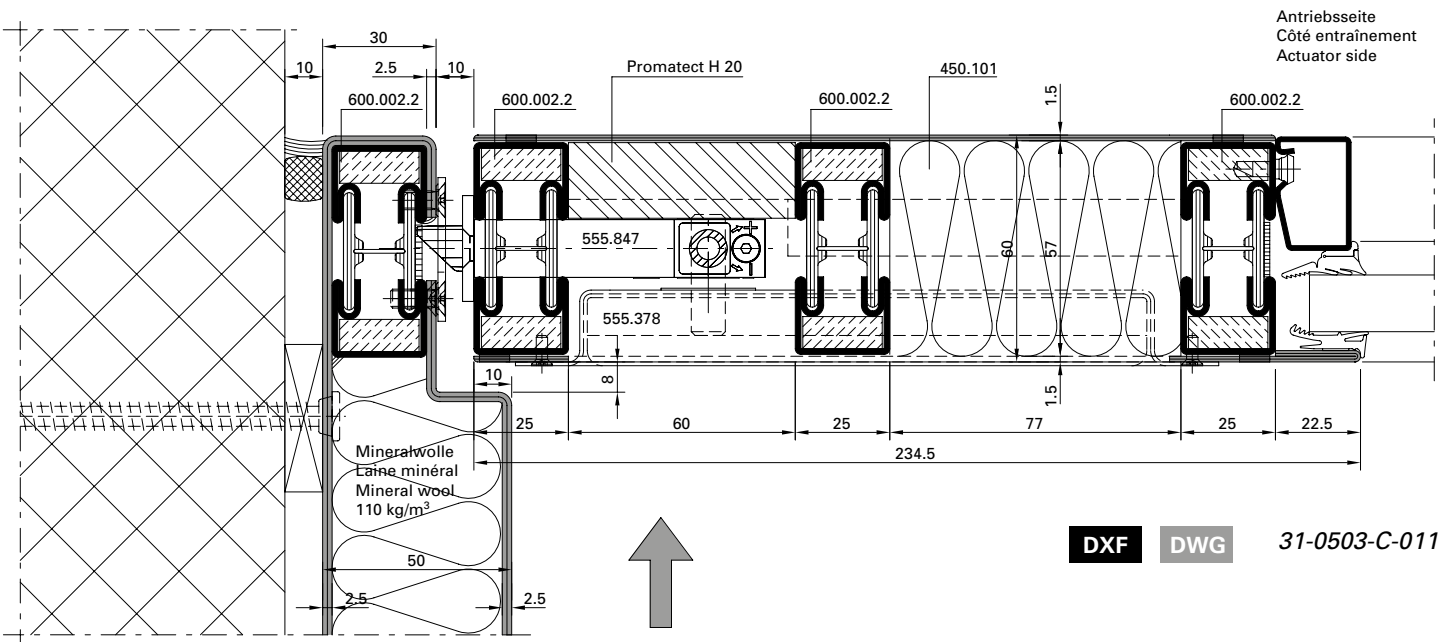

DXF DWG 31-0503-C-011

Statische Verstärkungen

Renforts statiques

Static reinforcements

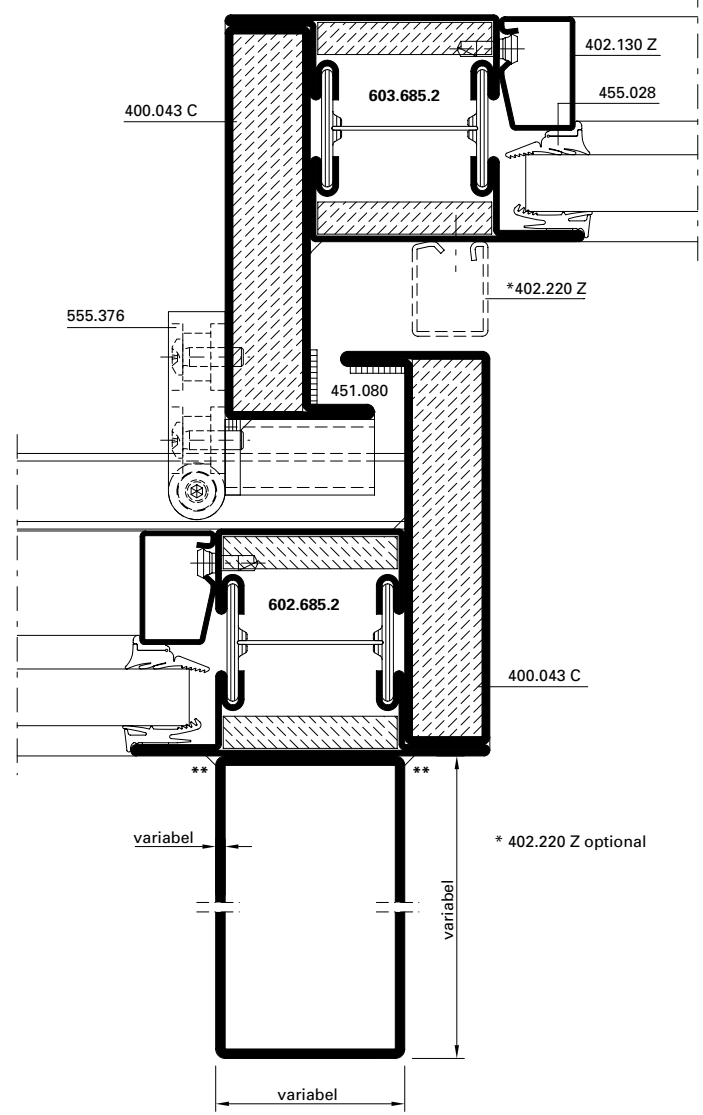
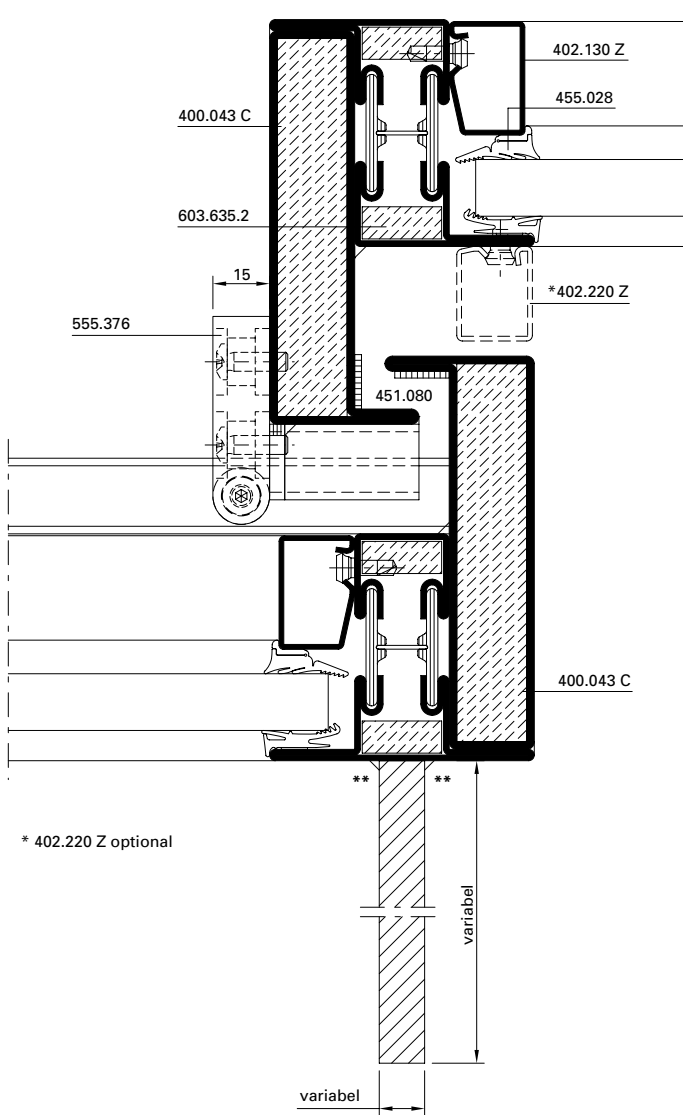

DXF

DWG

31-0501-K-001

DXF

DWG

31-0501-K-002

** Durchgehende Laserschweissung

** Soudage au laser en continu

** Continuous laser welding

Sturzverbreiterungen

Élargissements de linteau

Lintel extensions

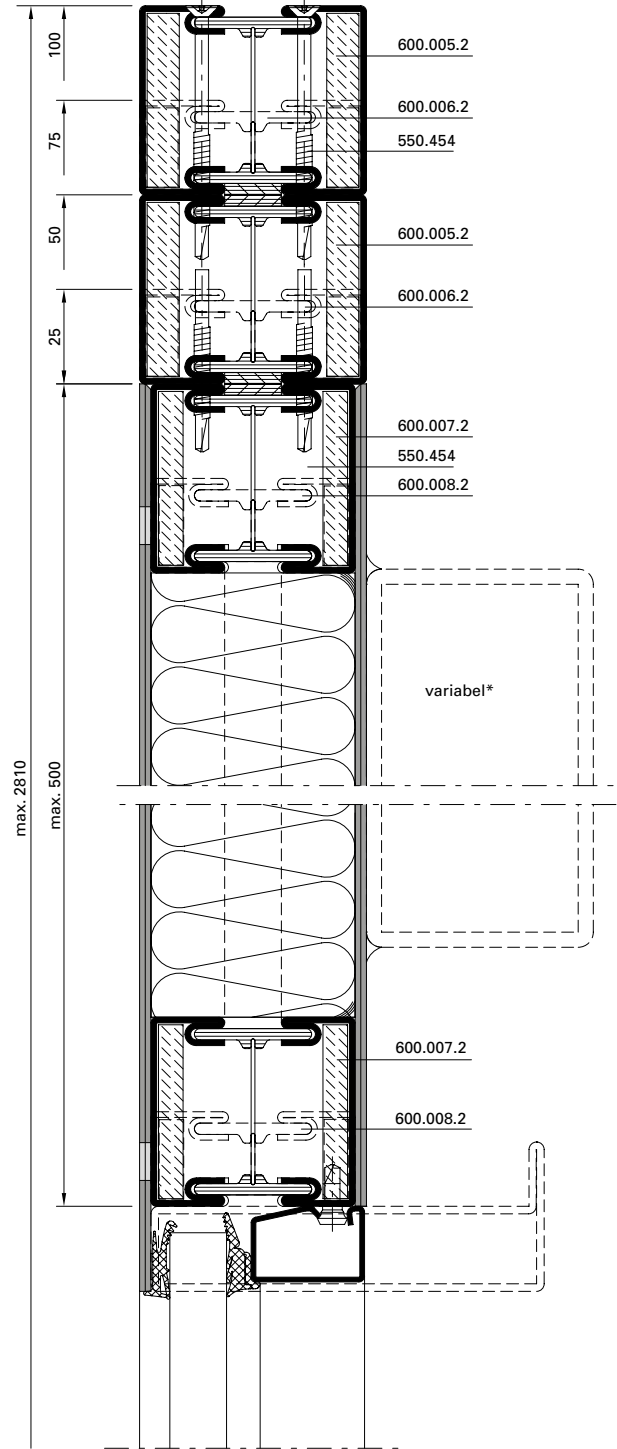
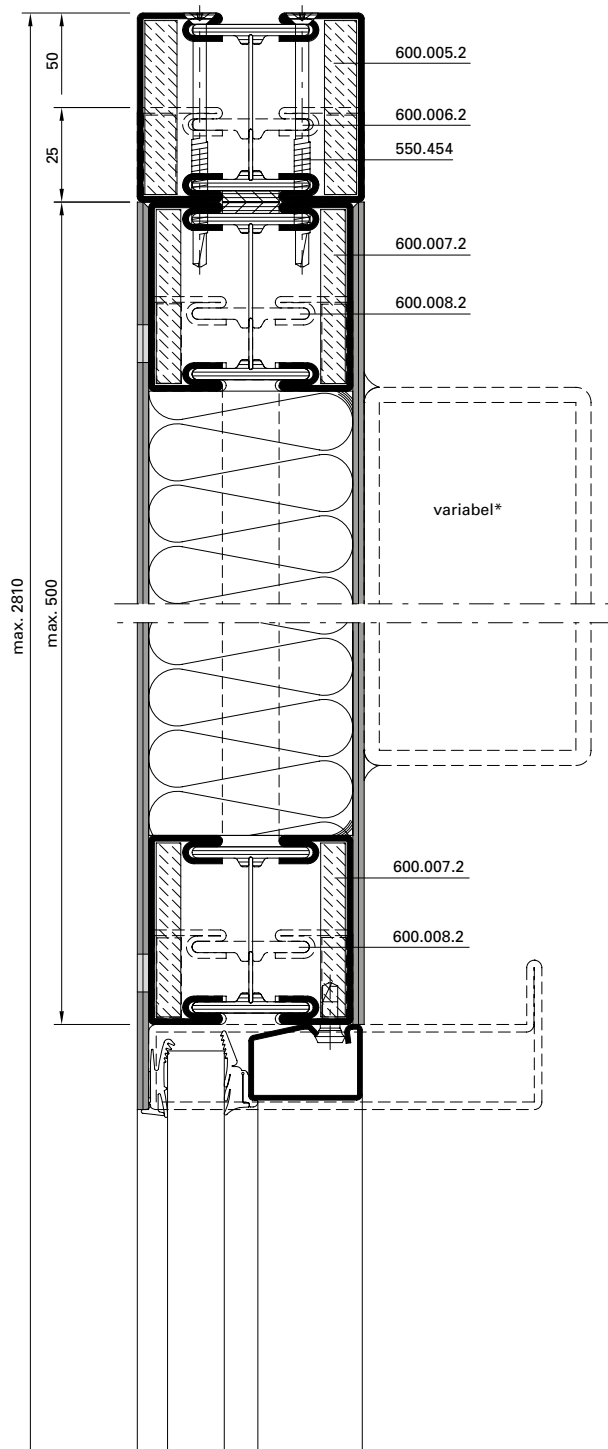

DXF **DWG** 31-0501-K-003

DXF **DWG** 31-0501-K-004

* entsprechend Antriebs-Lieferant

* comme prescrit par le fournisseur d'entraînement

* In accordance with actuator supplier

Sturzverbreiterungen mit
 Oberlicht

Élargissements de linteau
 avec imposte

Lintel extensions with toplight

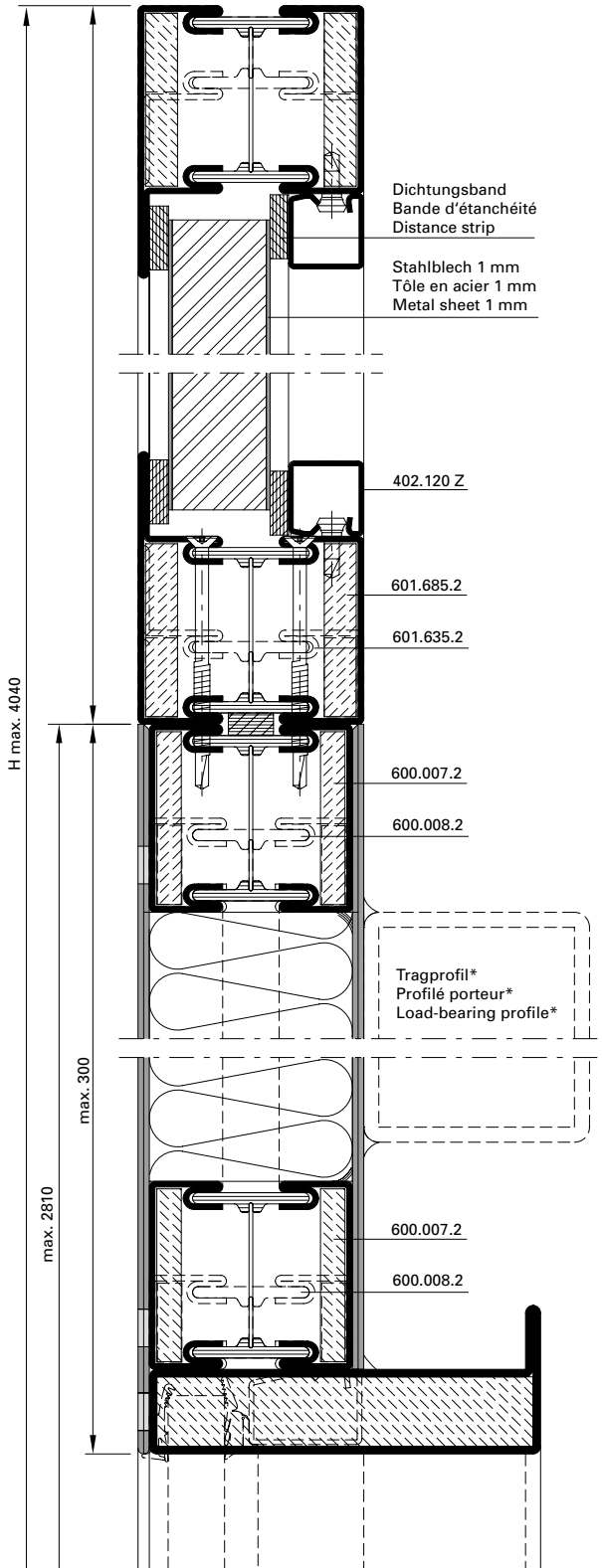

DXF **DWG** 31-0501-K-010

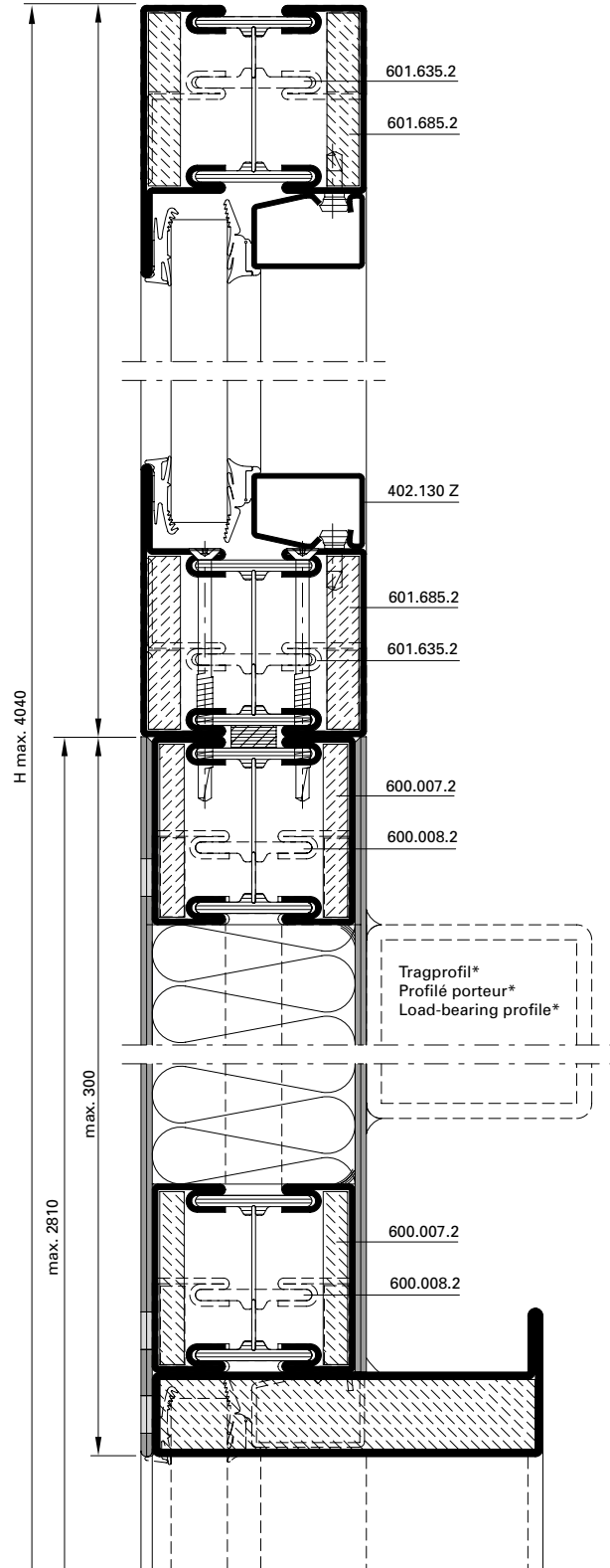

DXF **DWG** 31-0501-K-011

* entsprechend Antriebs-Lieferant

* comme prescrit par le fournisseur d'entraînement

* In accordance with actuator supplier

Sturzverbreiterungen mit
 Oberlicht

Élargissements de linteau
 avec imposte

Lintel extensions with toplight

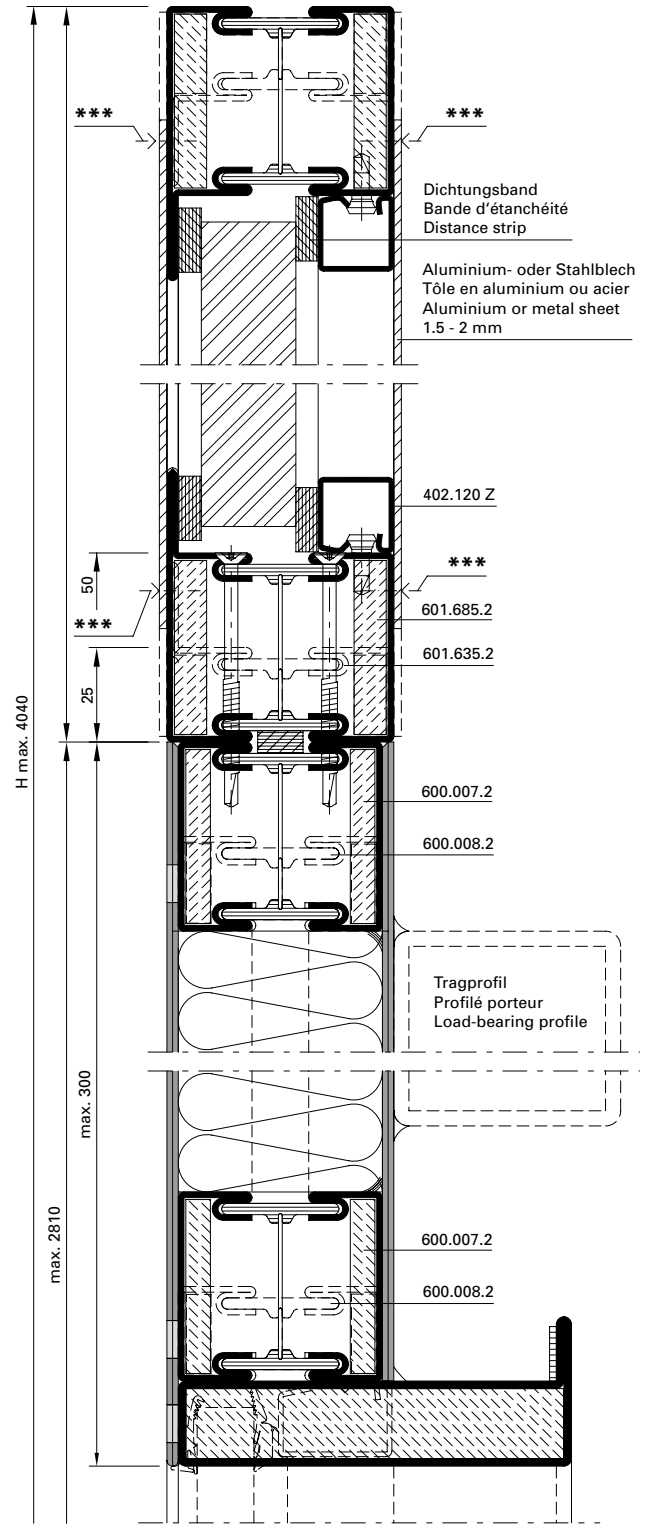
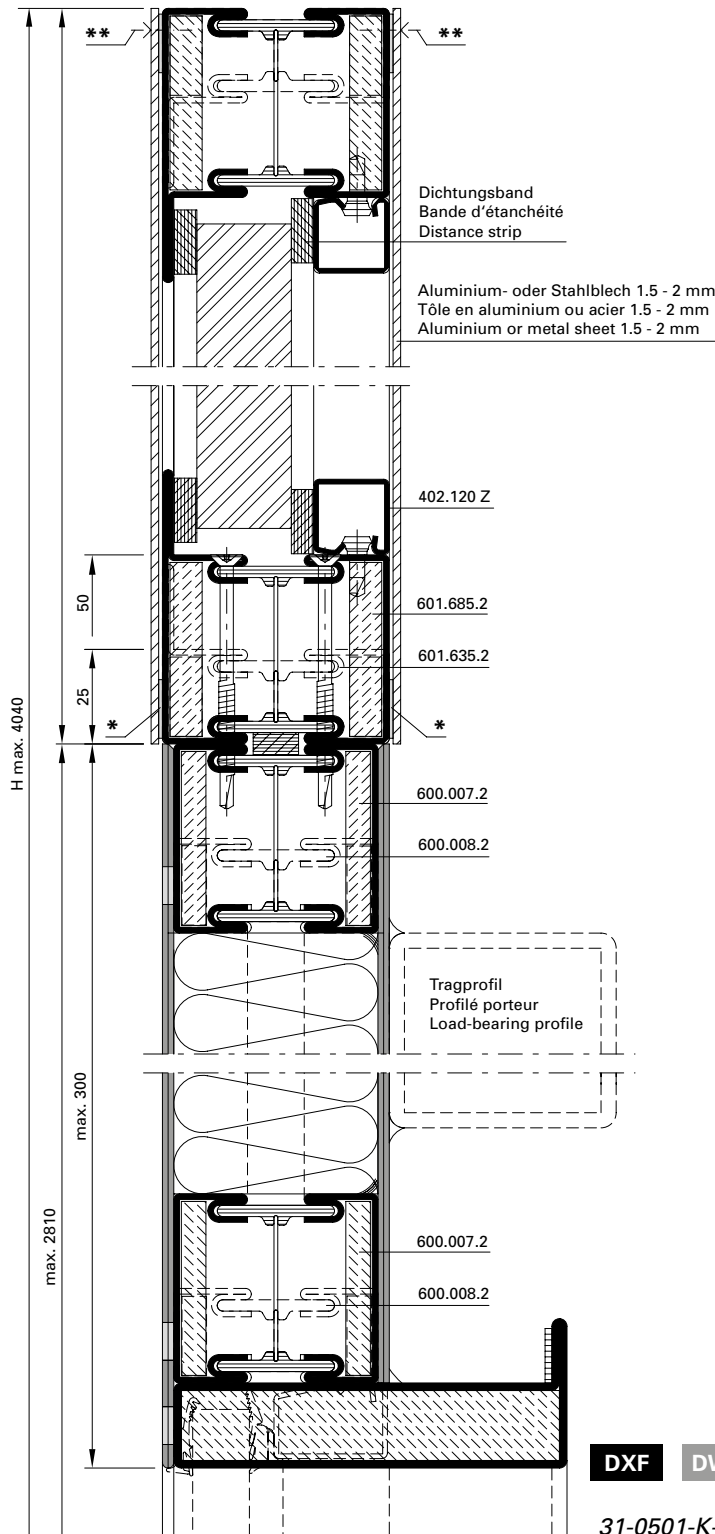

* Doppelklebeband z.B. 3M Scotch VHB 4956
 ** Blech oben mit min. 2 Schrauben $\geq \varnothing 3.9$ oder Stahl-Blindniete $\geq \varnothing 4$ sichern
 *** Schrauben $\geq \varnothing 3.9$ oder Stahl-Blindniete $\geq \varnothing 4$

* Ruban adhésif double face, p. ex. 3M Scotch VHB 4956
 ** Bloquer la tôle en haut avec au moins 2 vis $\geq \varnothing 3.9$ ou écrou aveugle en acier $\geq \varnothing 4$
 *** vis $\geq \varnothing 3.9$ ou écrou aveugle en acier $\geq \varnothing 4$

* Double-sided adhesive tape e.g. 3M Scotch VHB 4956
 ** Secure the sheet at the top using at least 2 screws $\geq \varnothing 3.9$ or blind steel rivets $\geq \varnothing 4$
 *** Screws $\geq \varnothing 3.9$ or blind steel rivets $\geq \varnothing 4$

Durchgangsbreiten
 Break-Out-Türen in Offenstellung

Largeurs de passage portes
 Break-Out ouvertes

Opening widths for Break-Out
 doors in the open position

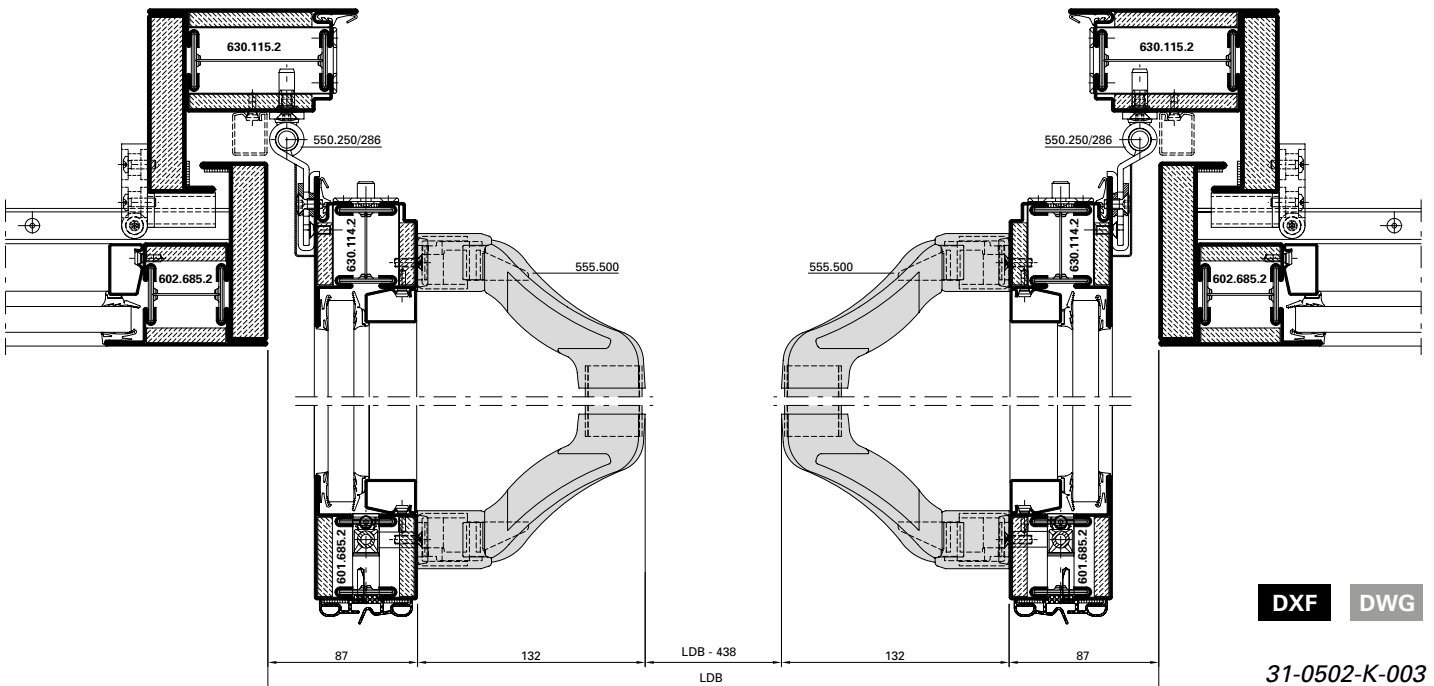
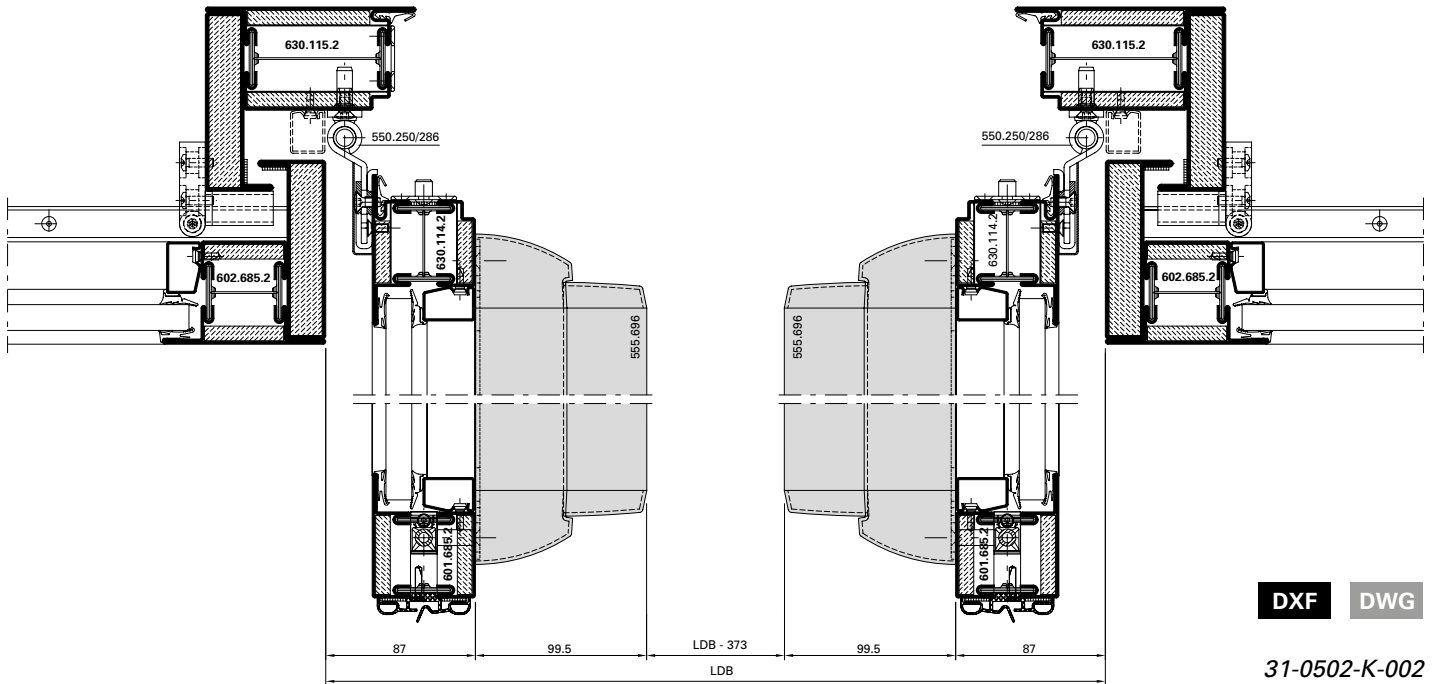

Durchgangsbreiten
 Break-Out-Türen in Offenstellung

Largeurs de passage portes
 Break-Out ouvertes

Opening widths for Break-Out
 doors in the open position

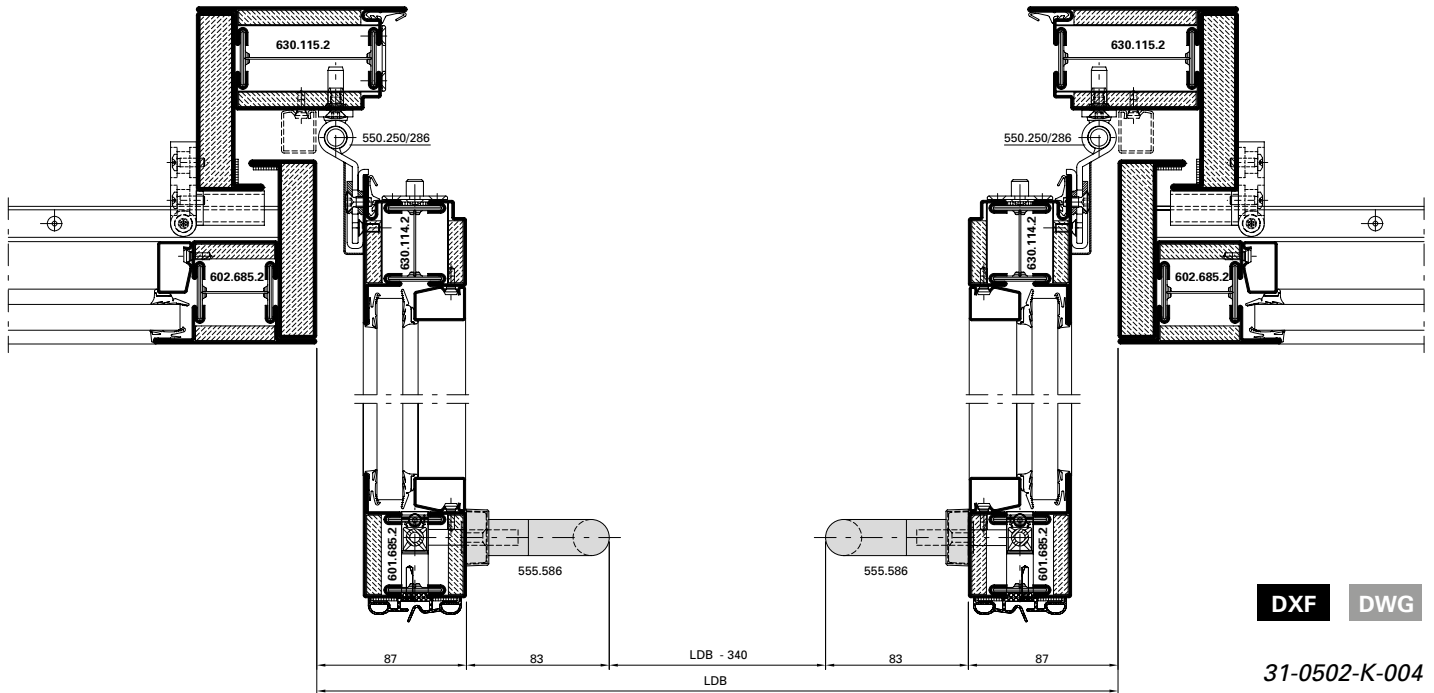

DXF DWG

31-0502-K-004

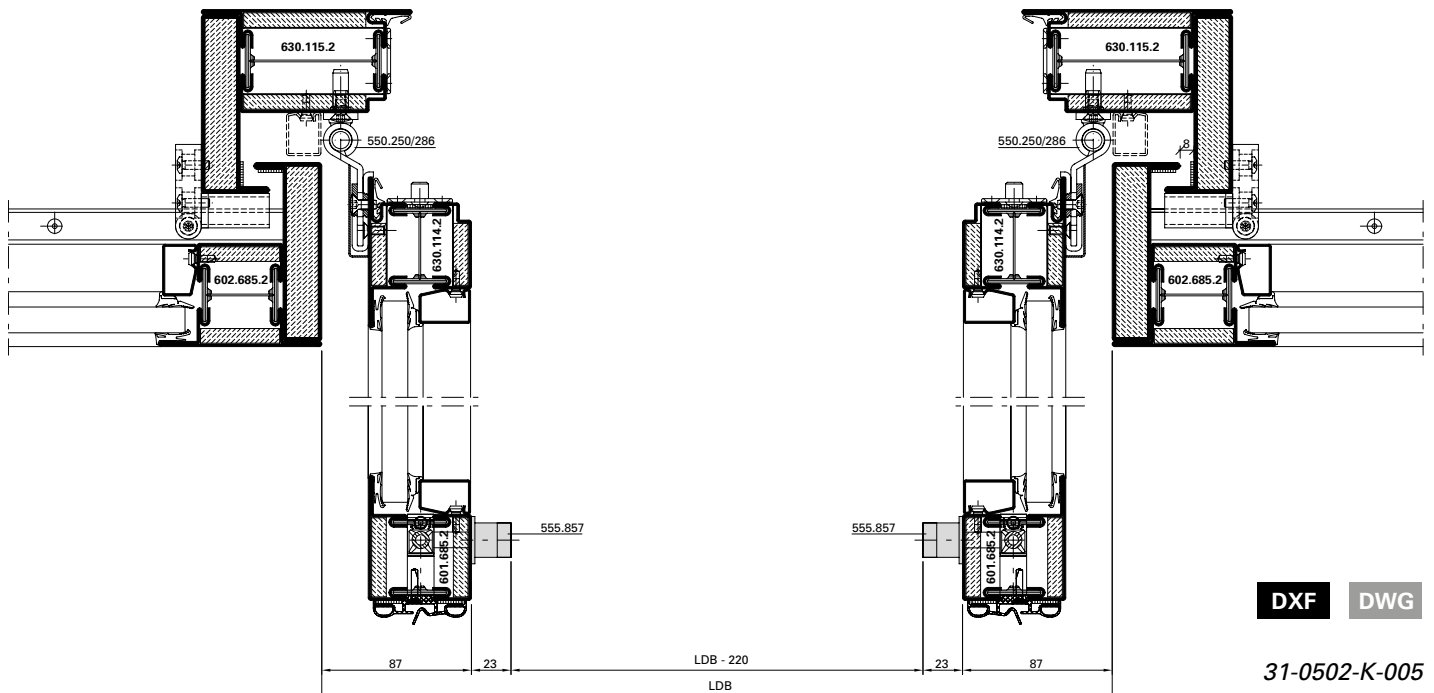

DXF DWG

31-0502-K-005

Durchgangsbreiten
 Break-In-Türen in Offenstellung

Largeurs de passage portes
 Break-In ouvertes

Opening widths for Break-In
 doors in the open position

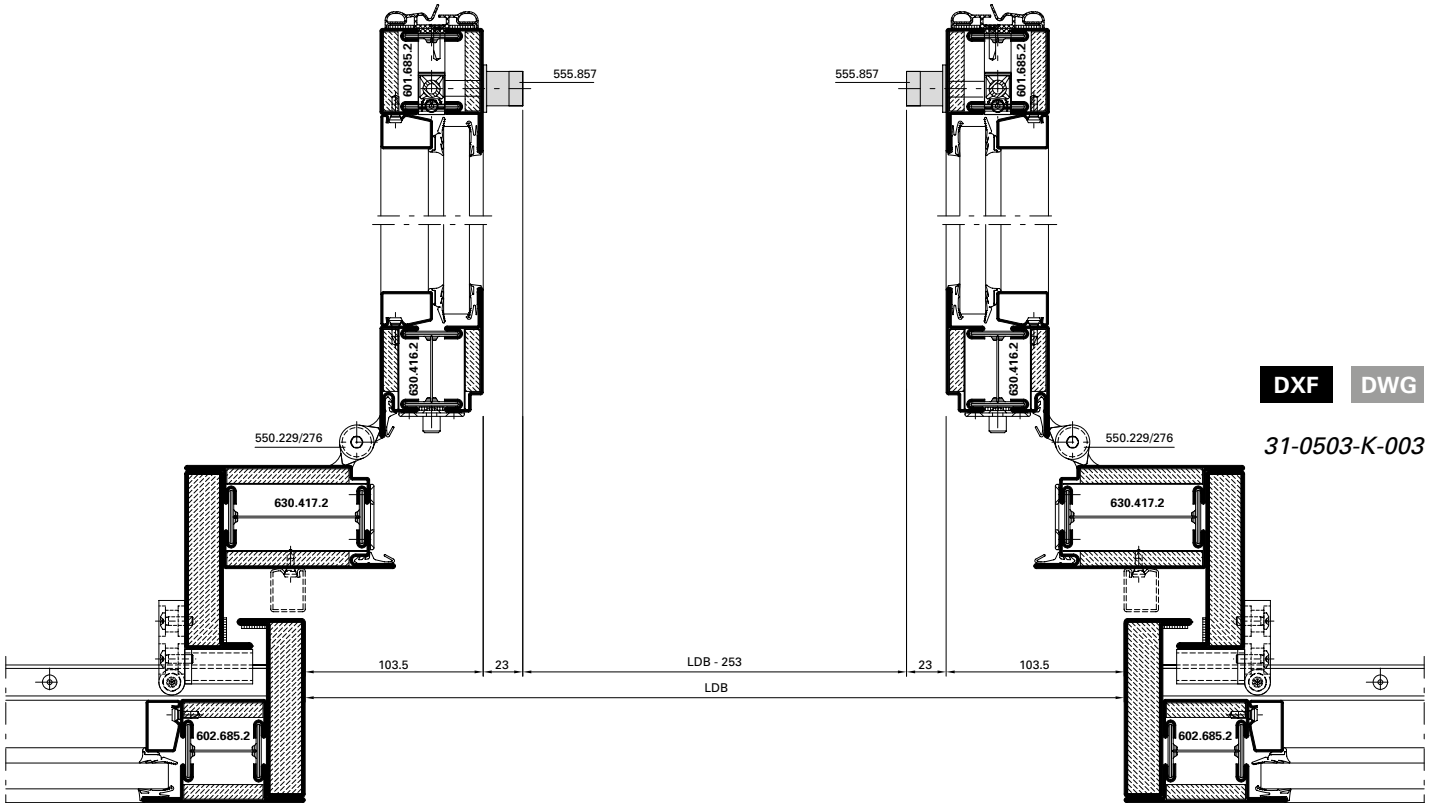
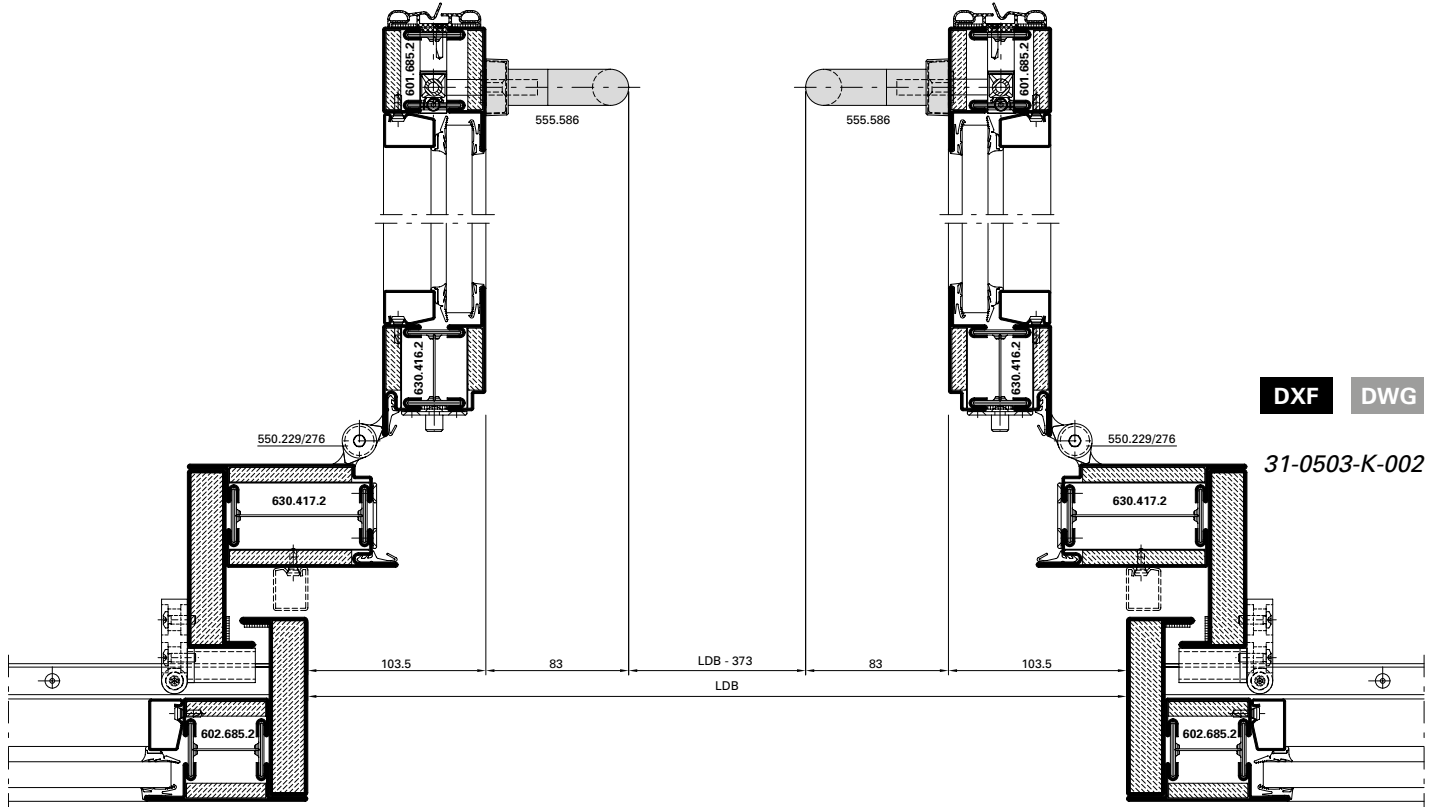

Durchgangsbreiten
Break-In-Türen in Offenstellung
(Variante mit Einlassgriff)

Largeurs de passage portes
Break-In ouvertes
(Variante avec poignée enchâssée)

Opening widths for Break-In
doors in the open position
(Option with recessed handle)

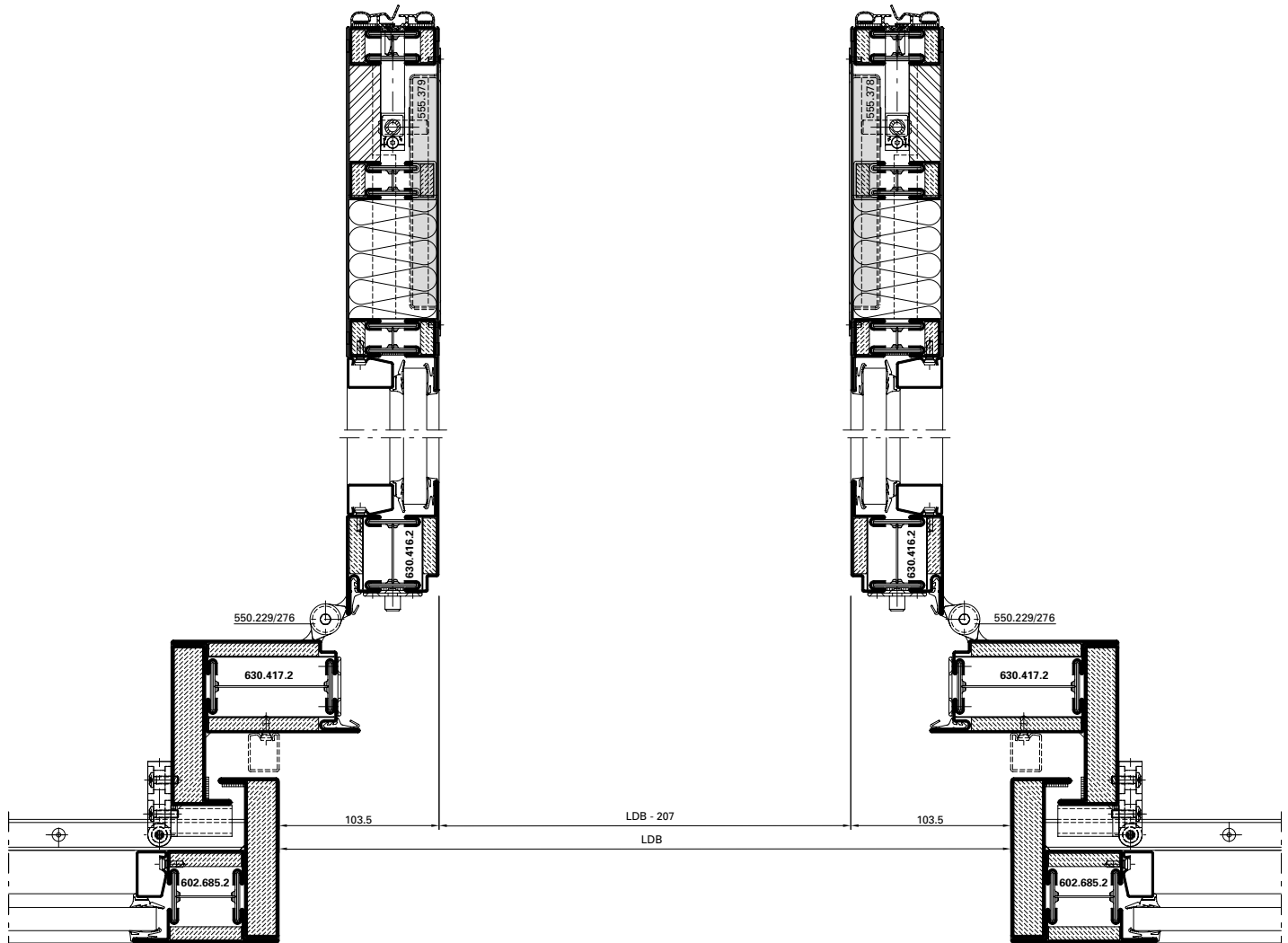

DXF

DWG

31-0503-K-004

Schiebetüre ohne Fluchttürfunktion
Antrieb: Tormax iMotion 2301 + 2401

Porte coulissante sans fonction porte de secours
Entraînement: Tormax iMotion 2301 + 2401

Sliding door without emergency exit function
Actuator: Tormax iMotion 2301 + 2401

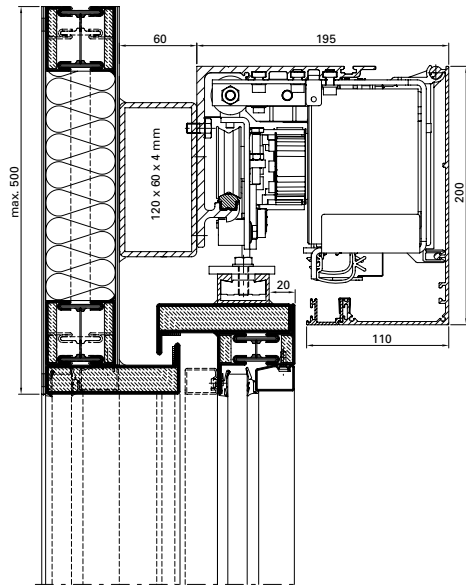

Schiebetüre mit Break-Out Fluchttürfunktion
Antrieb: Tormax iMotion 2302 + 2402

Porte coulissante avec fonction porte de secours Break-Out
Entraînement: Tormax iMotion 2302 + 2402

Sliding door with Break-Out emergency exit function
Actuator: Tormax iMotion 2302 + 2402

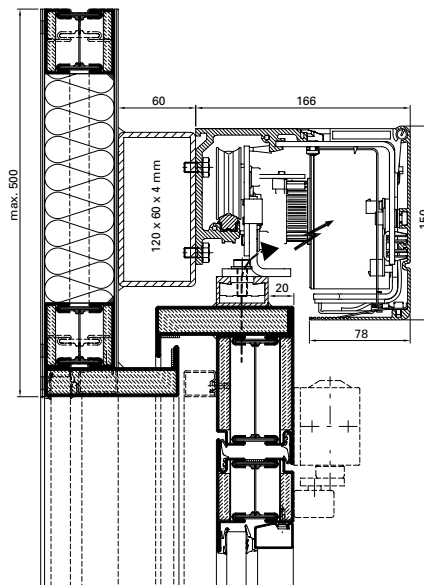

Schiebetüre ohne Fluchttürfunktion
Antrieb: Record STA 20

Porte coulissante sans fonction porte de secours
Entraînement: Record STA 20

Sliding door without emergency exit function
Actuator: Record STA 20

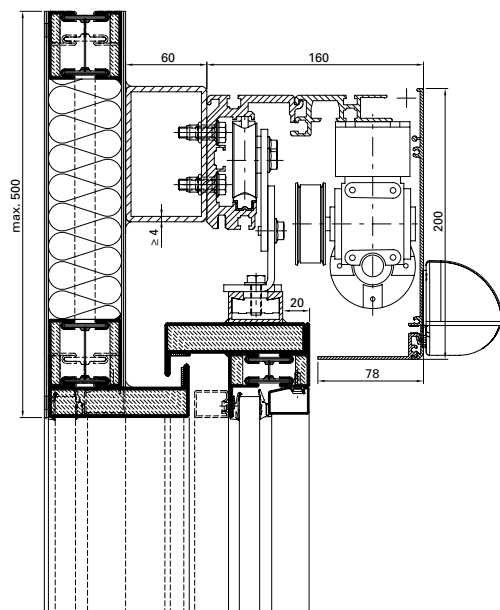

Schiebetüre mit Break-Out Fluchttürfunktion
Antrieb: Record STA 20

Porte coulissante avec fonction porte de secours Break-Out
Entraînement: Record STA 20

Sliding door with Break-Out emergency exit function
Actuator: Record STA 20

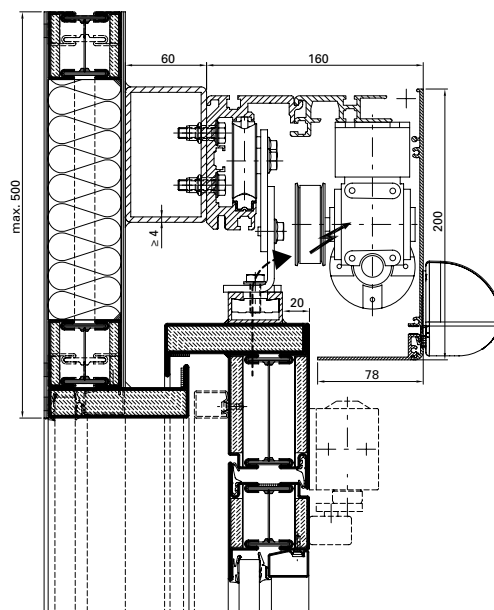

Schiebetüre ohne Fluchttürfunktion
Antrieb: GEZE Powerdrive PL

Porte coulissante sans fonction porte de secours
Entraînement: GEZE Powerdrive PL

Sliding door without emergency exit function
Actuator: GEZE Powerdrive PL

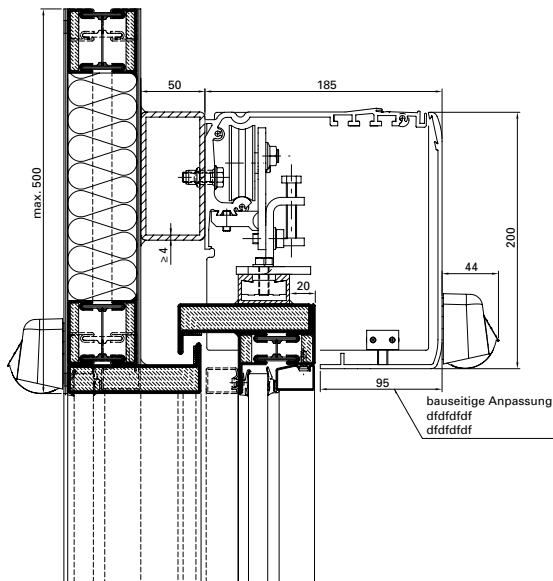

Schiebetüre mit Break-Out Fluchttürfunktion
Antrieb: GEZE Powerdrive PL

Porte coulissante avec fonction porte de secours Break-Out
Entraînement: GEZE Powerdrive PL

Sliding doors with Break-Out emergency exit function
Actuator: GEZE Powerdrive PL

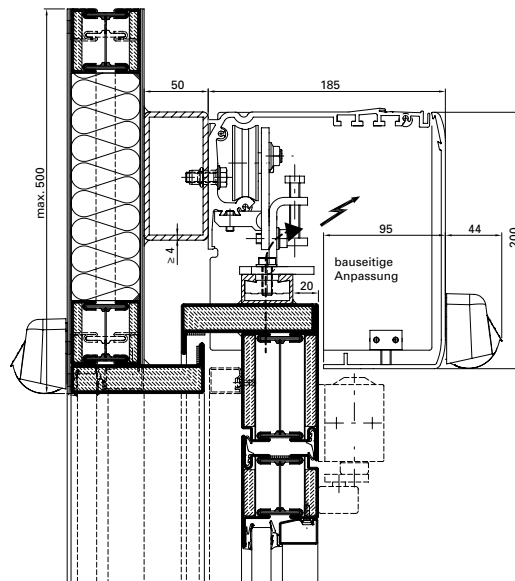

Schiebetüre ohne Fluchttürfunktion
Antrieb: Dorma ES-200

Porte coulissante sans fonction porte de secours
Entraînement: Dorma ES-200

Sliding door without emergency exit function
Actuator: Dorma ES-200

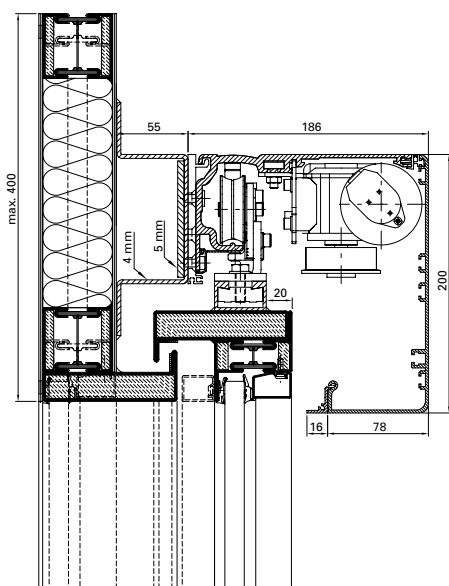

Schiebetüre mit Break-Out Fluchttürfunktion
Antrieb: Dorma ES-200

Porte coulissante avec fonction porte de secours Break-Out
Entraînement: Dorma ES-200

Sliding doors with Break-Out emergency exit function
Actuator: Dorma ES-200

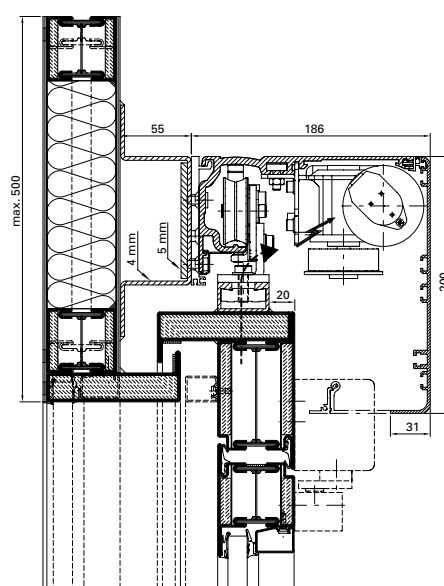

Konstruktionsdetails

Détails de construction

Construction details

Brandschutzschiebetüre EI30

Porte coulissante coupe-feu EI30

Fire-resistant sliding door EI30

Schiebetüre ohne Fluchttürfunktion

Antrieb: Gilgen SLX-M (bis 150 kg)
Gilgen SLX-V (ab 150 kg)

Porte coulissante sans fonction porte de secours

Entraînement: Gilgen SLX-M (jusqu'à 150 kg)
Gilgen SLX-V (dès 150 kg)

Sliding door without emergency exit function

Actuator: Gilgen SLX-M (to 150 kg)
Gilgen SLX-V (from 150 kg)

Schiebetüre mit Break-Out Fluchttürfunktion

Antrieb: Gilgen SLX-M (bis 150 kg)
Gilgen SLX-V (ab 150 kg)

Porte coulissante avec fonction porte de secours Break-Out

Entraînement: Gilgen SLX-M (jusqu'à 150 kg)
Gilgen SLX-V (dès 150 kg)

Sliding doors with Break-Out emergency exit function

Actuator: Gilgen SLX-M (to 150 kg)
Gilgen SLX-V (from 150 kg)

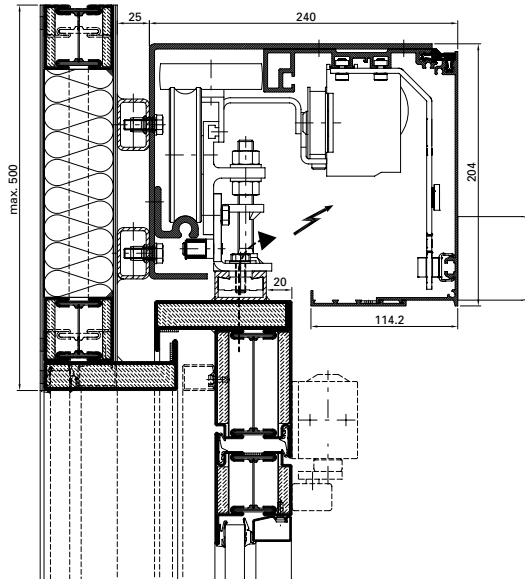
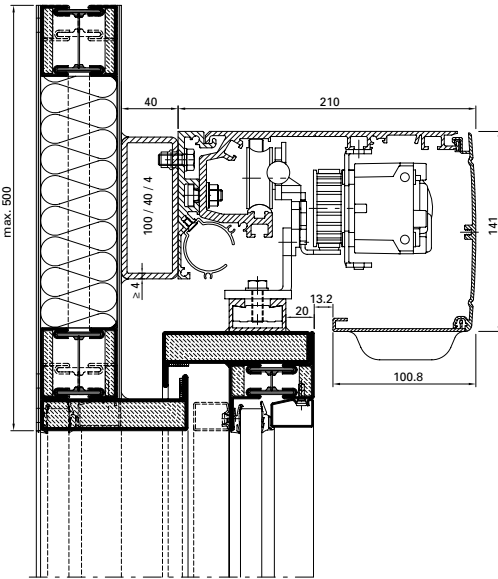

Anschlüsse am Bau im Masstab 1:2

Raccords au mur à l'échelle 1:2

Attachment to structure on scale 1:2

Brandschutzschiebetüre EI30

Porte coulissante coupe-feu EI30

Fire-resistant sliding door EI30

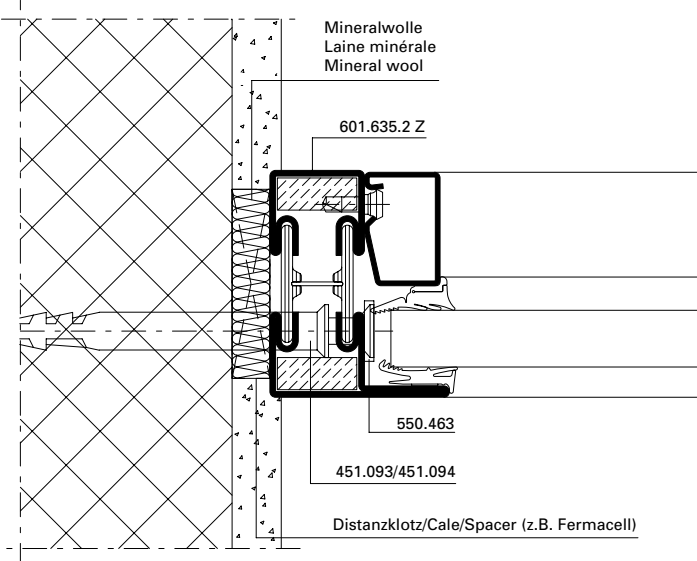

DXF DWG 31-0101-A-001

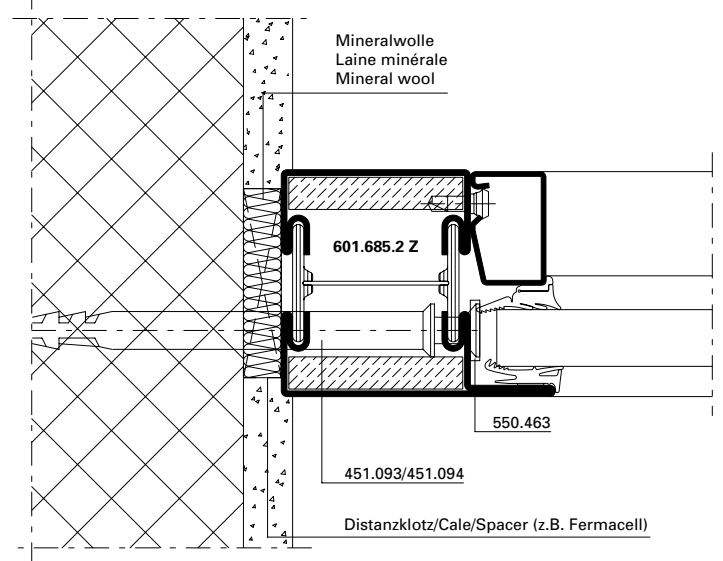

DXF DWG 31-0101-A-002

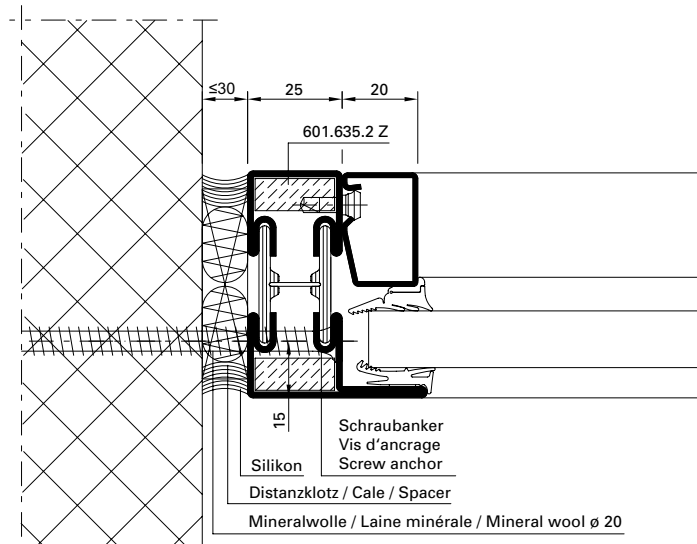

DXF DWG 31-0101-A-047

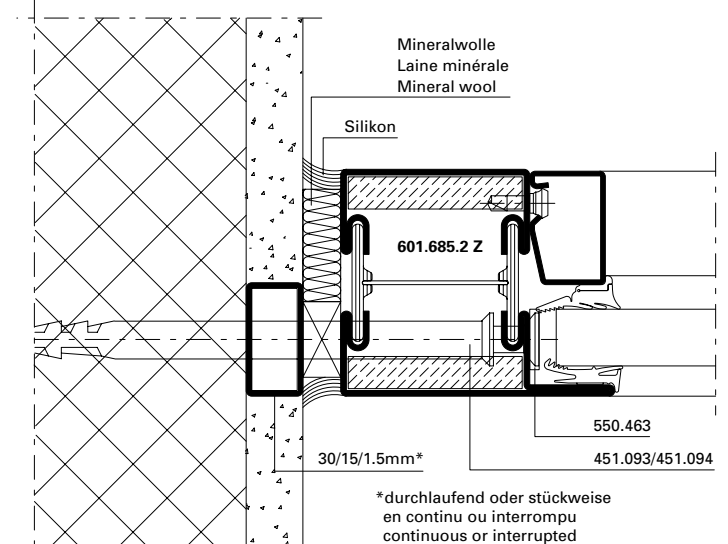

DXF DWG 31-0101-A-004

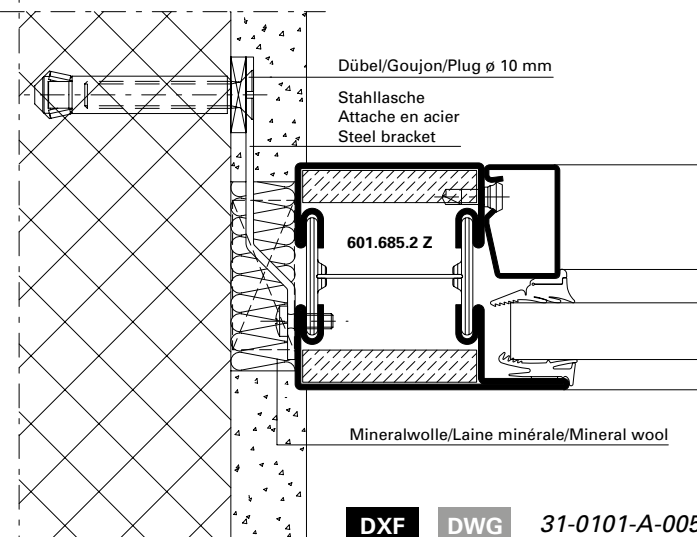

DXF DWG 31-0101-A-005

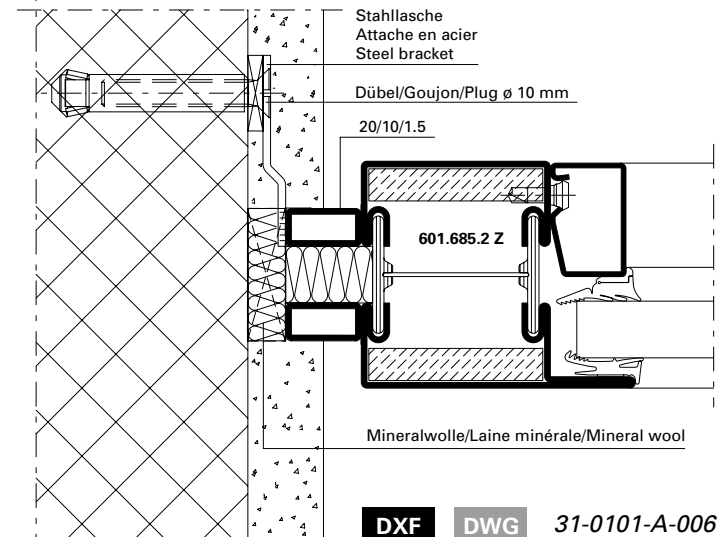

DXF DWG 31-0101-A-006

Anschlüsse am Bau im Massstab 1:2

Raccords au mur à l'échelle 1:2

Attachment to structure on scale 1:2

Brandschutzschiebetüre EI30

Porte coulissante coupe-feu EI30

Fire-resistant sliding door EI30

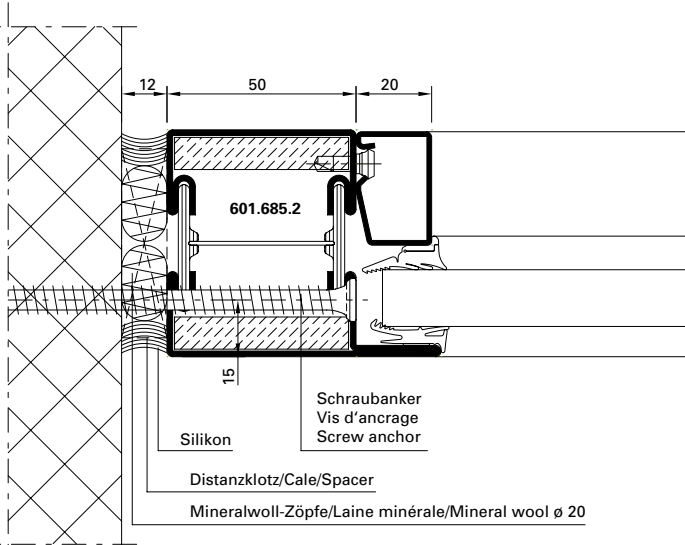

DXF DWG 31-0101-A-043

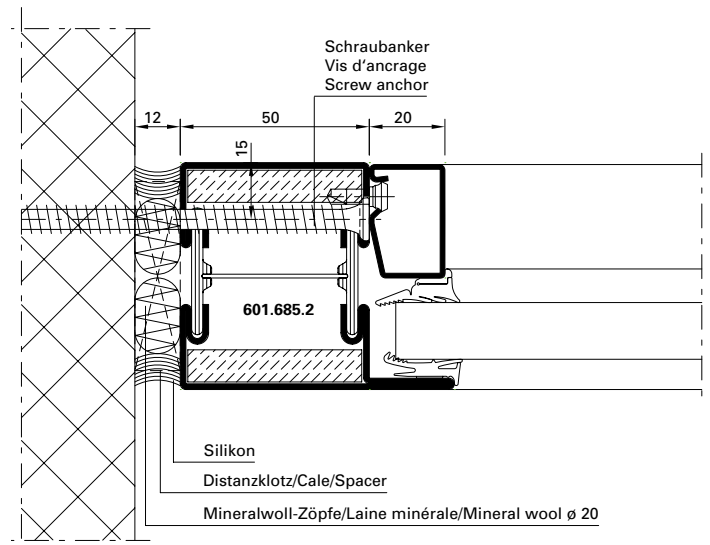

DXF DWG 31-0101-A-044

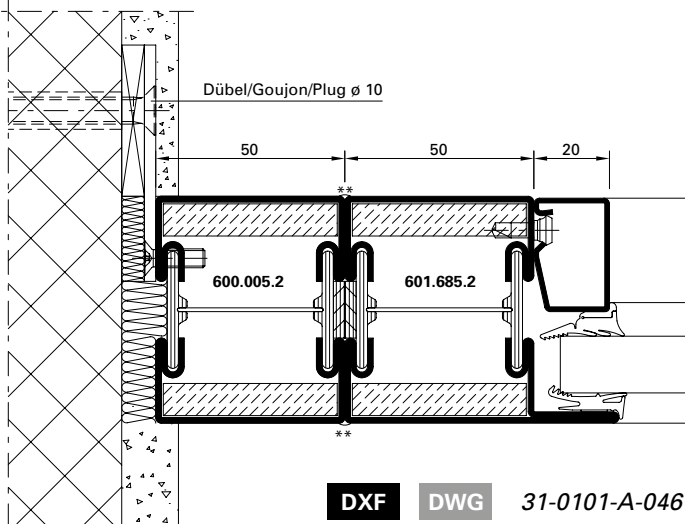

DXF DWG 31-0101-A-046

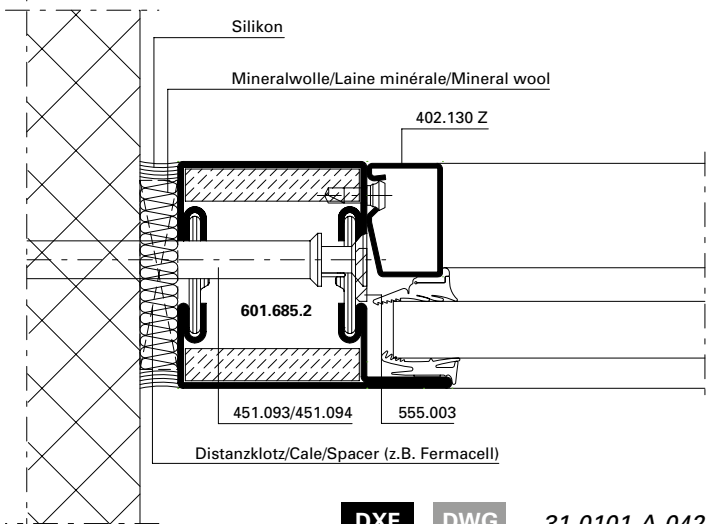

DXF DWG 31-0101-A-042

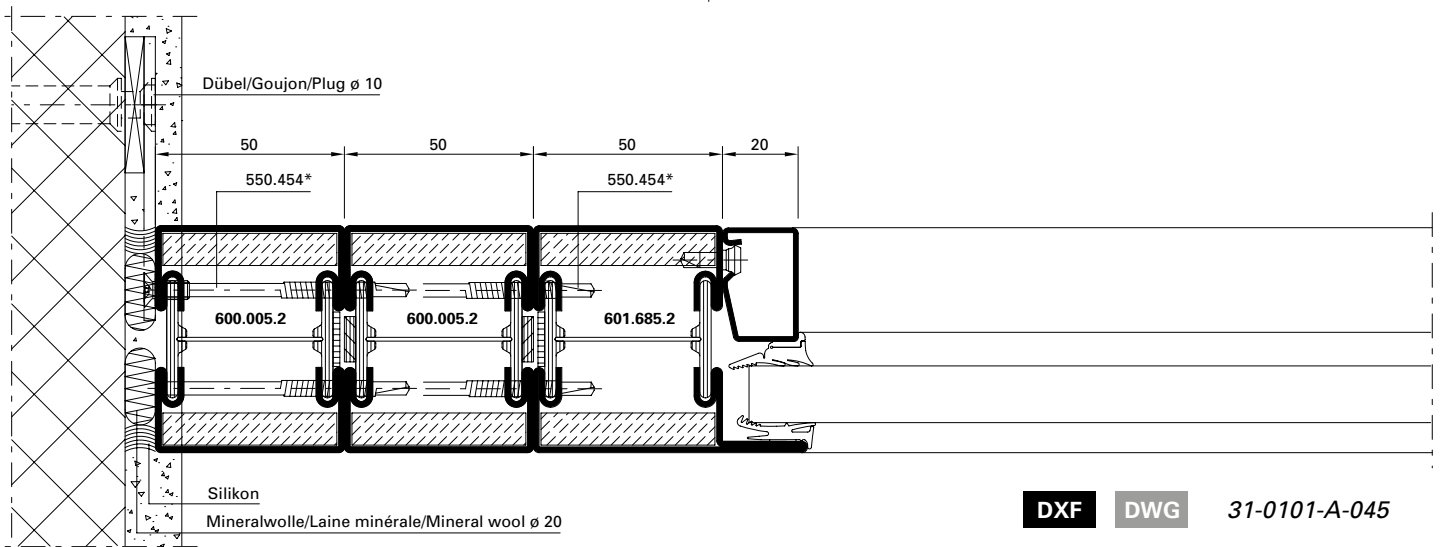

DXF DWG 31-0101-A-045

* Schrauben-Abstand \leq 300 mm

* Distance des vis \leq 300 mm

* Screw distance \leq 300 mm

** Durchgehende Laserschweißung

** Soudage au laser en continu

** Continuous laser welding

Anschlüsse am Bau im Masstab 1:2

Raccords au mur à l'échelle 1:2

Attachment to structure on scale 1:2

Brandschutzschiebetüre EI30

Porte coulissante coupe-feu EI30

Fire-resistant sliding door EI30

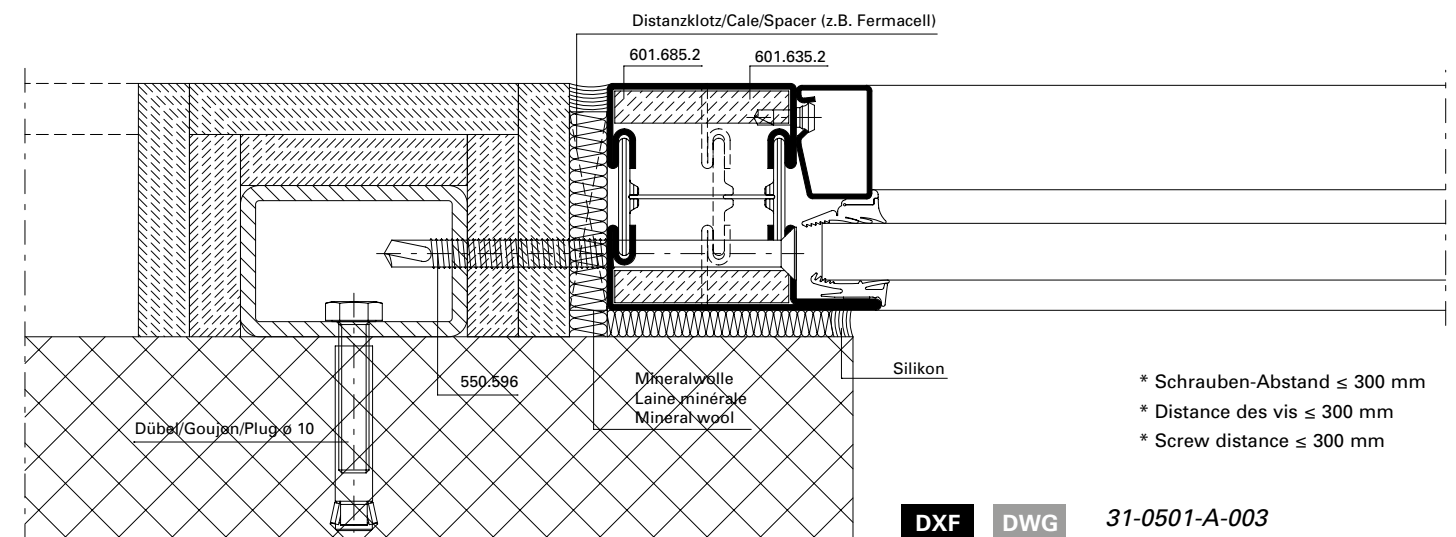
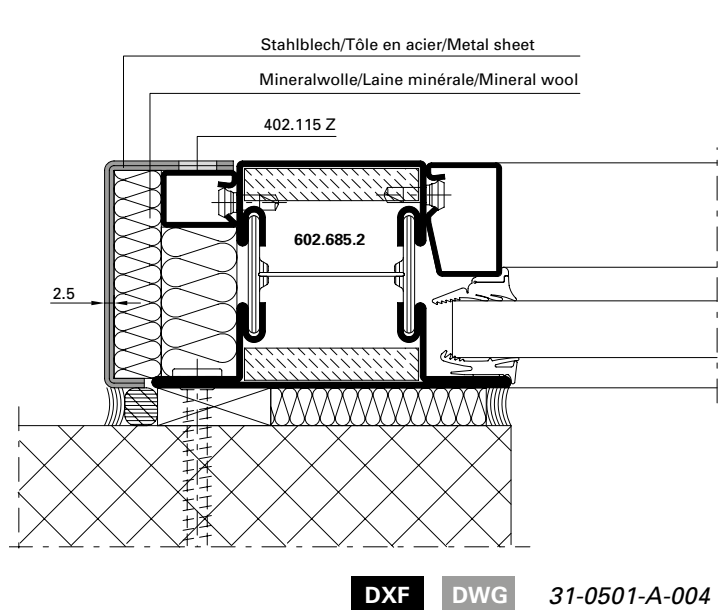
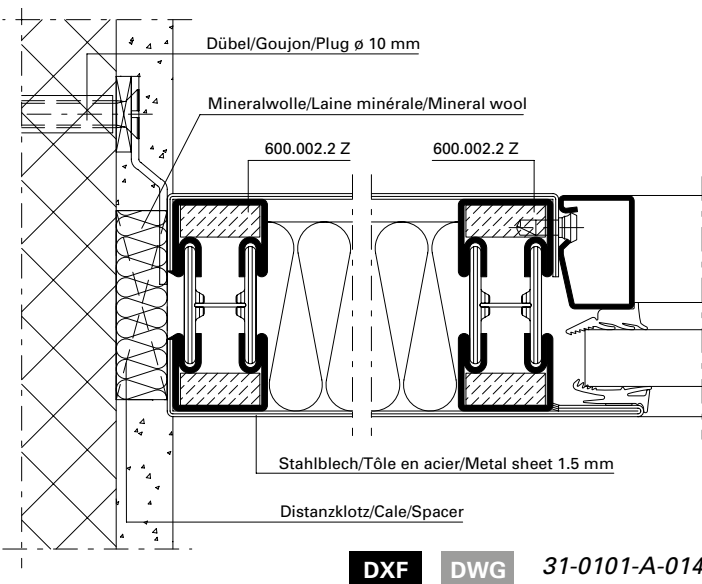
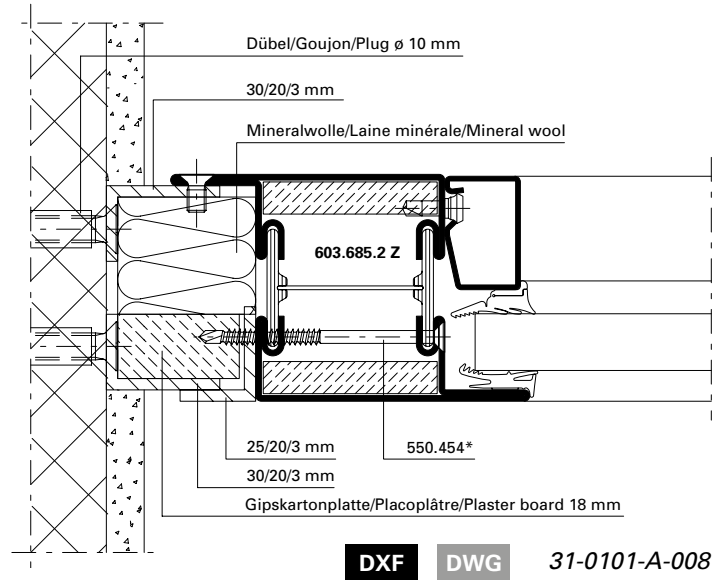
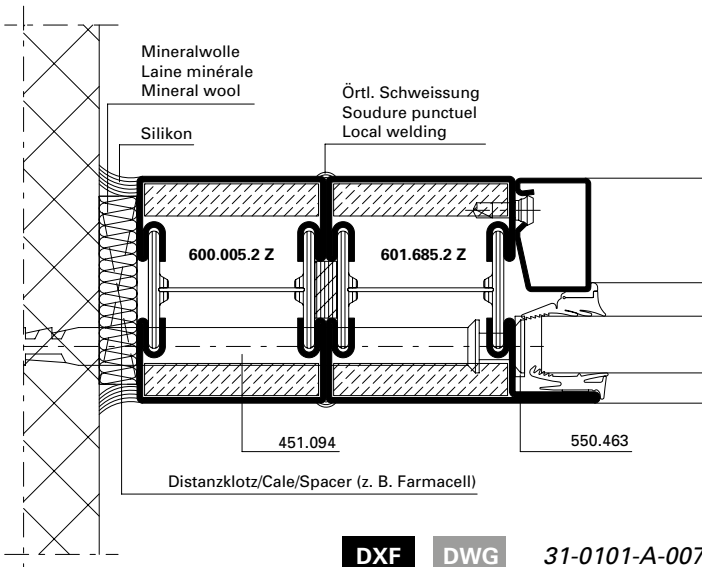

Anschlüsse am Bau im Massstab 1:2
Raccords au mur à l'échelle 1:2
Attachment to structure on scale 1:2

Brandschutzschiebetüre EI30
Porte coulissante coupe-feu EI30
Fire-resistant sliding door EI30

Porenbeton
(z.B. Ytong, Siporex, Hebel etc.)

Béton cellulaire
(par ex. Ytong, Siporex, Hebel etc.)

Aerated concrete
(e.g. Ytong, Siporex, Hebel etc.)

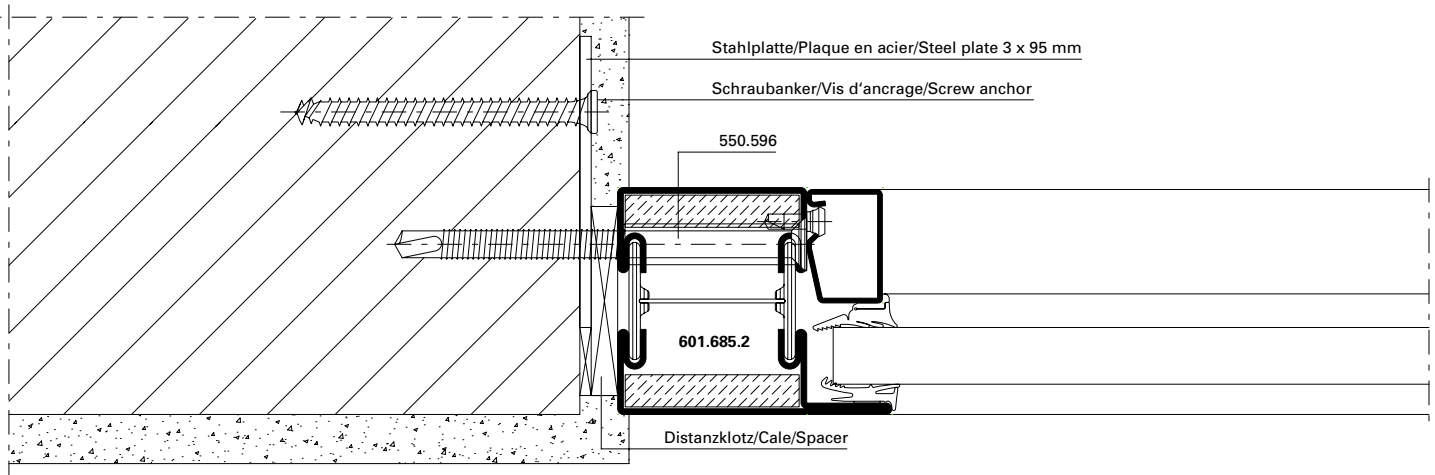
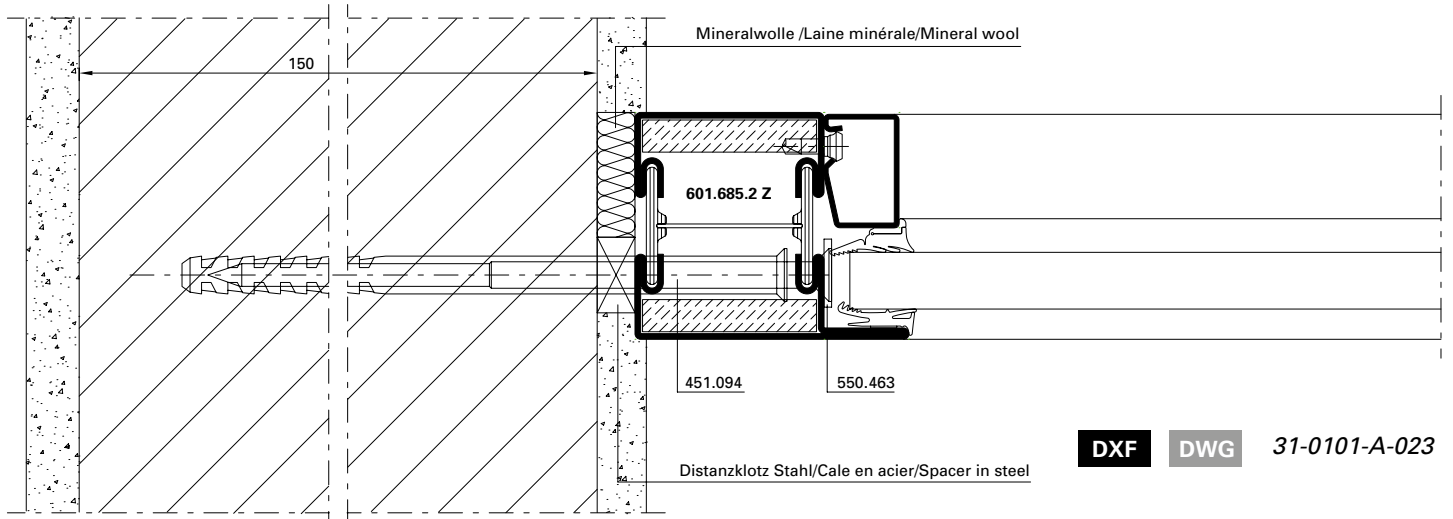

Anschlüsse am Bau im Masstab 1:2
 Raccords au mur à l'échelle 1:2
 Attachment to structure on scale 1:2

Brandschutzschiebetüre EI30
 Porte coulissante coupe-feu EI30
 Fire-resistant sliding door EI30

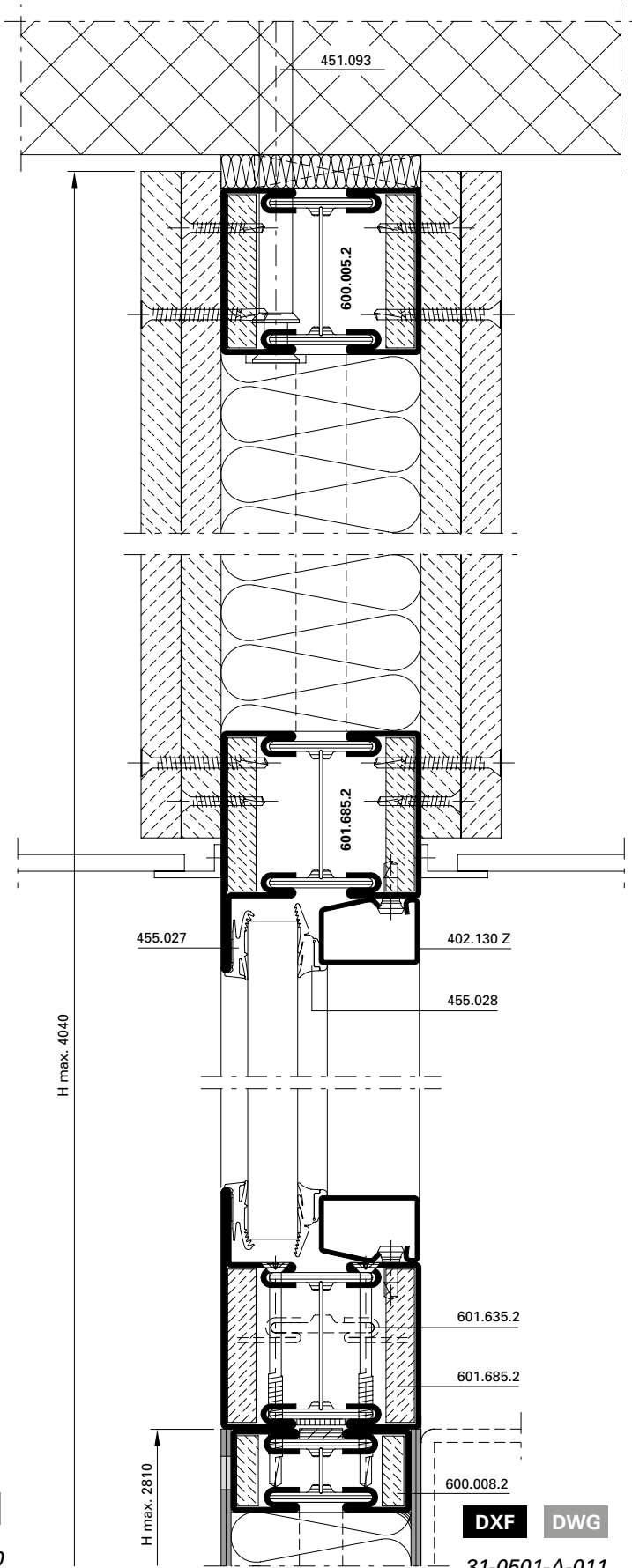
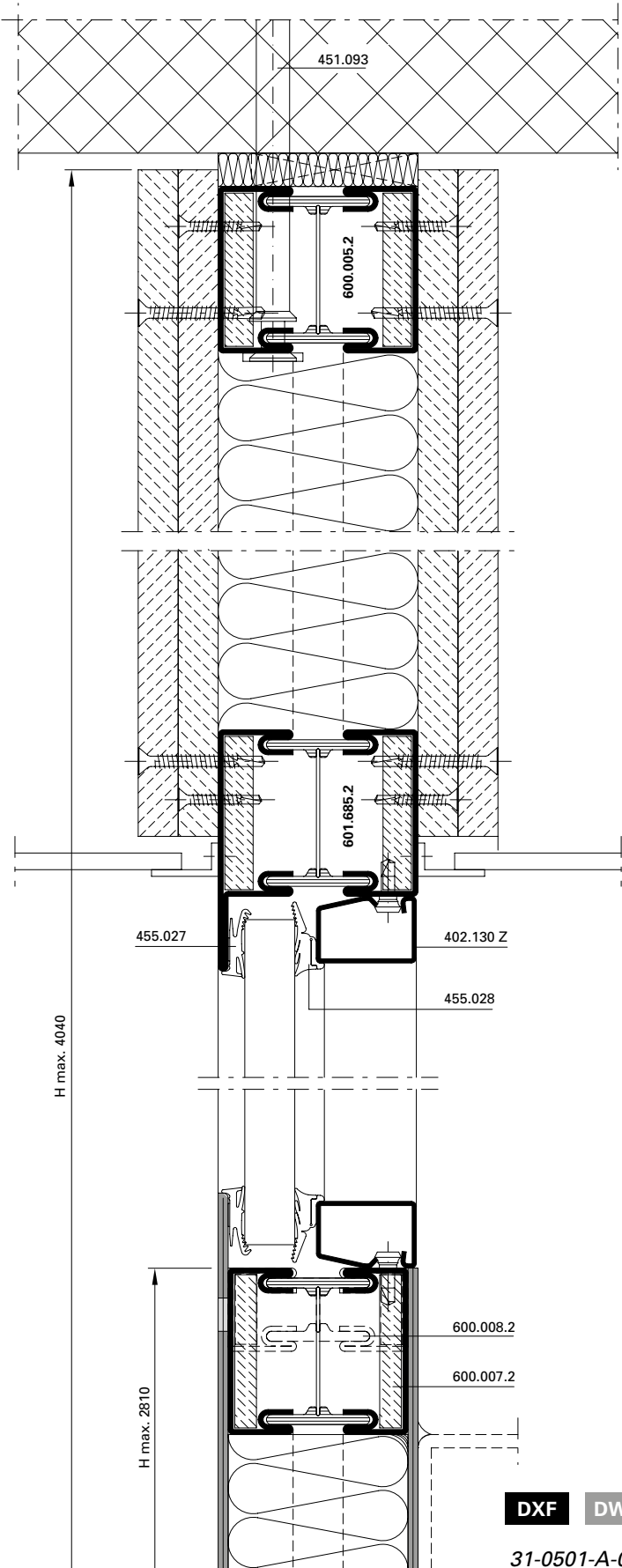

Anschluss an
Leichtbauwand/Endloswand

Anschluss an Raccordement à une
paroi de construction légère/de
largeur illimitée

Attachment to lightweight
partition wall/continuous wall

Die Brandschutz-Verkleidung der Stahlstütze muss um eine Brandschutzklasse höher ausgebildet sein, als die Schiebetüre resp. das Seitenteil (z.B. EI30 → EI60)
Le revêtement coupe-feu du support en acier doit avoir une classe de protection incendie supérieure à celle de la porte coulissante et de la partie latérale (p. ex. EI30 → EI60)
The fire-resistant cladding on the steel supports must be one fire resistance class higher than the sliding doors and the side sections (e.g. EI30 → EI60)

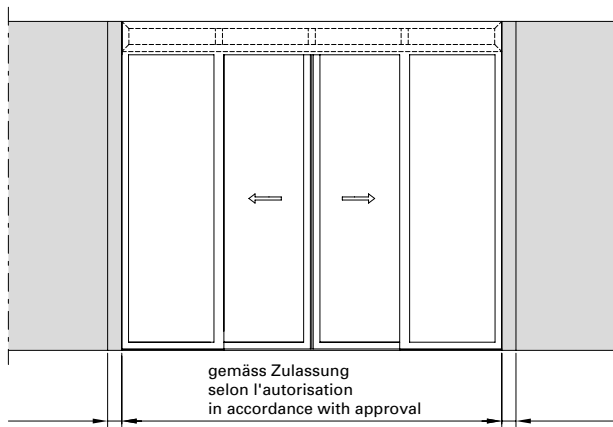
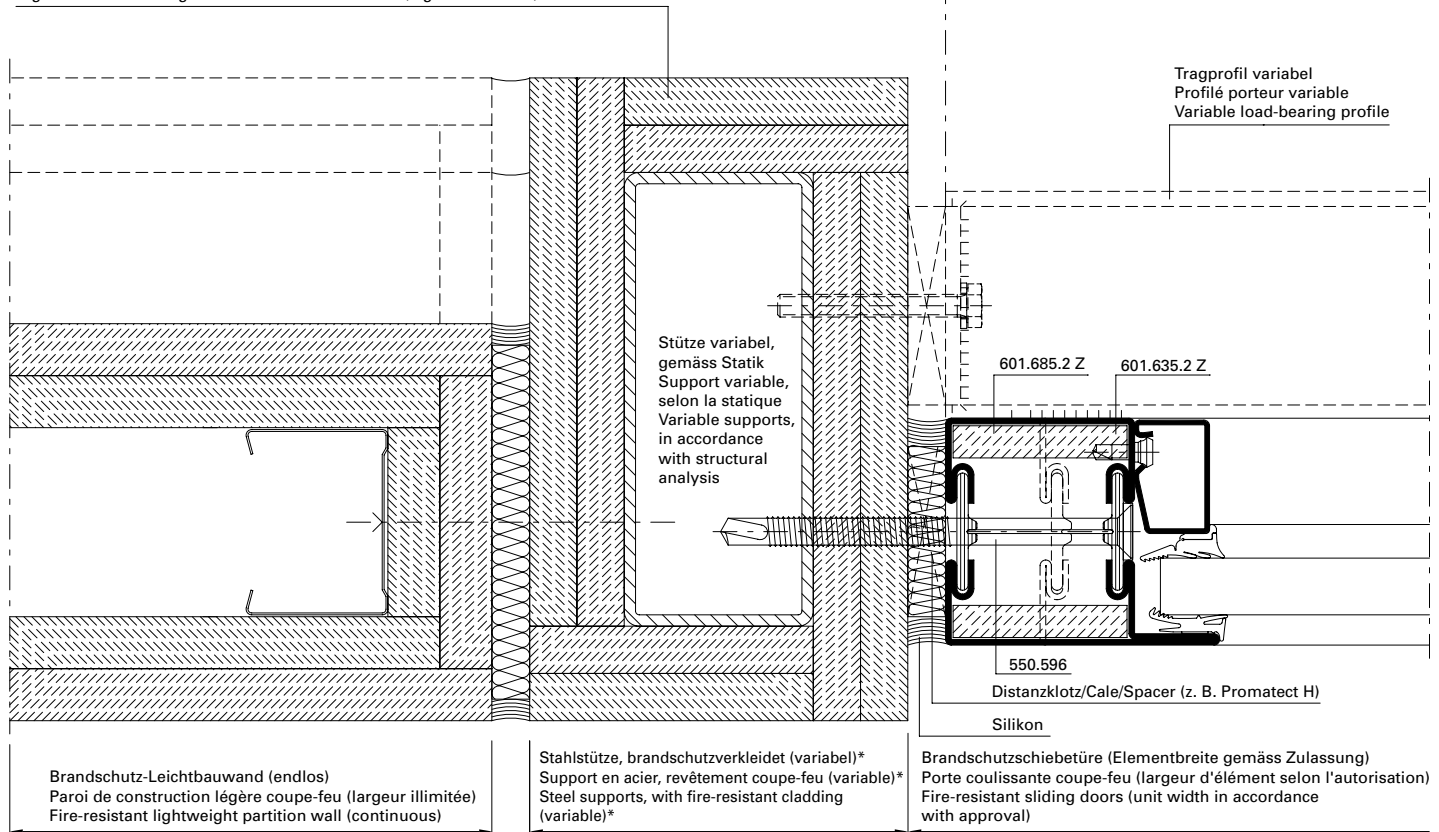

DXF

DWG

31-0501-A-012

* Brandschutz-Verkleidung entsprechend
Vorschrift Feuerpolizei resp.
Fabrikat-Zulassung

* Revêtement coupe-feu selon les
prescriptions de la police du feu et de
l'autorisation du produit

* Fire-resistant cladding in accordance with
the regulations of the fire authorities and
the manufacturer's approval

Anschlüsse am Bau im Massstab 1:2
Raccords au mur à l'échelle 1:2
Attachment to structure on scale 1:2

Brandschutzschiebetüre EI30
Porte coulissante coupe-feu EI30
Fire-resistant sliding door EI30

Anschluss an verglaste
Brandschutz-Seitenteile/Endloswand

Raccordement à des parties latérales
coupe-feu vitrées/à la paroi à
largeur illimitée

Attachment to glazed fire-resistant
side sections/continuous wall

Die Brandschutz-Verkleidung der Stahlstütze muss um eine Brandschutzklasse höher ausgebildet sein, als die Schiebetüre resp. das Seitenteil (z.B. EI30 → EI60)
 Le revêtement coupe-feu du support en acier doit avoir une classe de protection incendie supérieure à celle de la porte coulissante et de la partie latérale (p. ex. EI30 → EI60)
 The fire-resistant cladding on the steel supports must be one fire resistance class higher than the sliding doors and the side sections (e.g. EI30 → EI60)

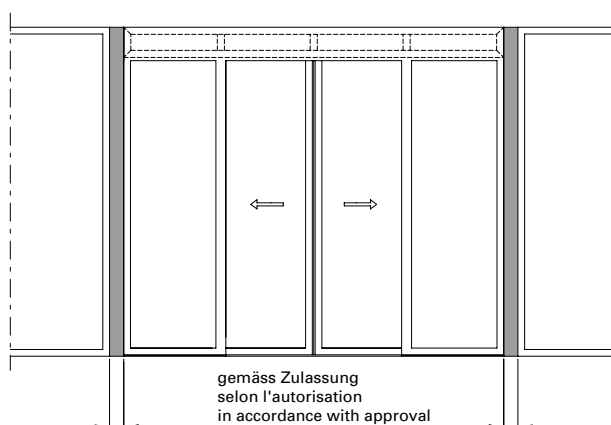
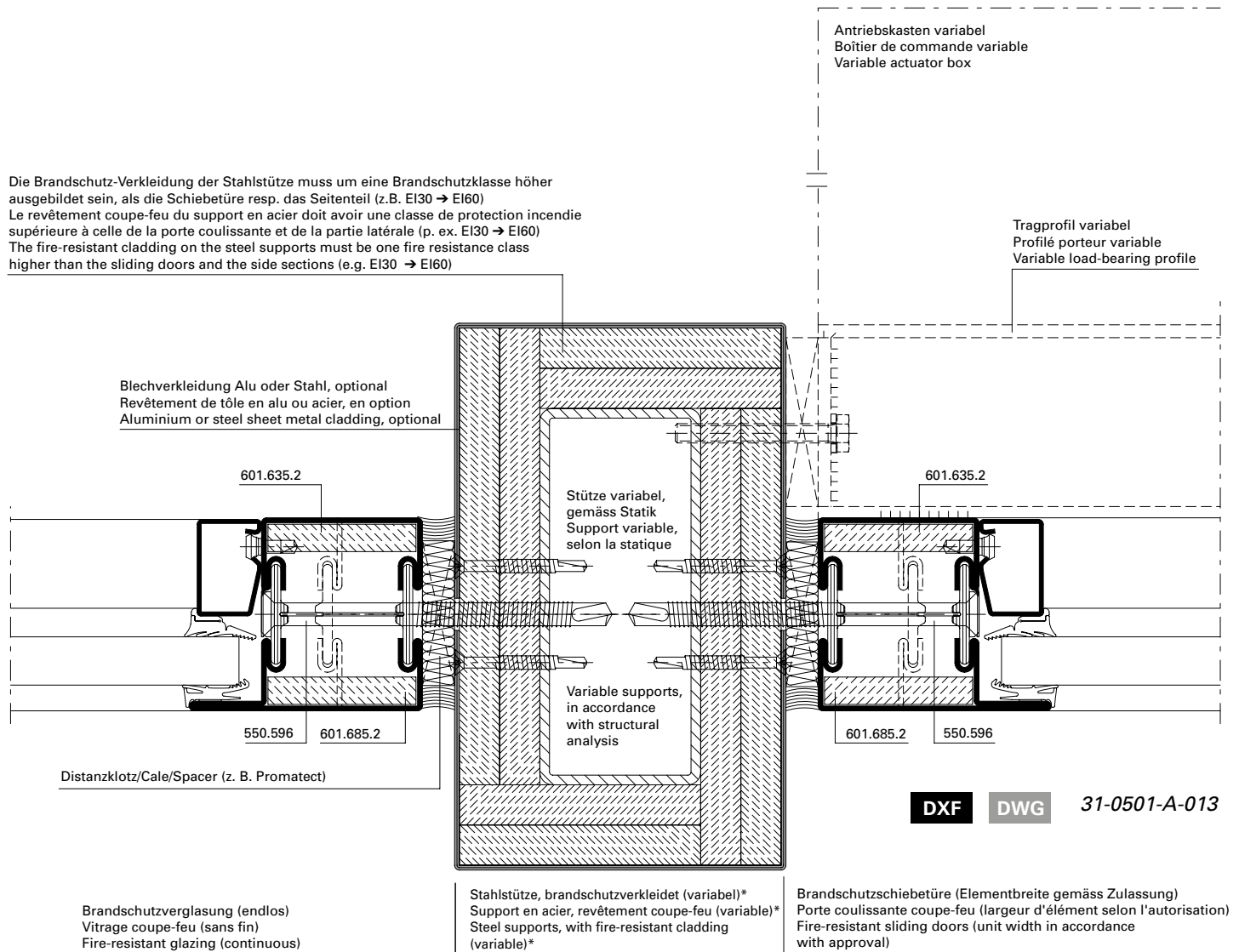

* Brandschutz-Verkleidung entsprechend
 Vorschrift Feuerpolizei resp.
 Fabrikat-Zulassung

* Revêtement coupe-feu selon les
 prescriptions de la police du feu et de
 l'autorisation du produit

* Fire-resistant cladding in accordance with
 the regulations of the fire authorities and
 the manufacturer's approval

Anschlüsse am Bau im Massstab 1:2
Raccords au mur à l'échelle 1:2
Attachment to structure on scale 1:2

Brandschutzschiebetüre EI30
Porte coulissante coupe-feu EI30
Fire-resistant sliding door EI30

Anschluss an verglaste Brandschutz-Seitenteile/Endloswand

Raccordement à des parties latérales coupe-feu vitrées/à la paroi à largeur illimitée

Attachment to glazed fire-resistant side sections/continuous wall

Die Brandschutz-Verkleidung der Stahlstütze muss um eine Brandschutzklasse höher ausgebildet sein, als die Schiebetüre resp. das Seitenteil (z.B. EI30 → EI60)
 Le revêtement coupe-feu du support en acier doit avoir une classe de protection incendie supérieure à celle de la porte coulissante et de la partie latérale (p. ex. EI30 → EI60)
 The fire-resistant cladding on the steel supports must be one fire resistance class higher than the sliding doors and the side sections (e.g. EI30 → EI60)

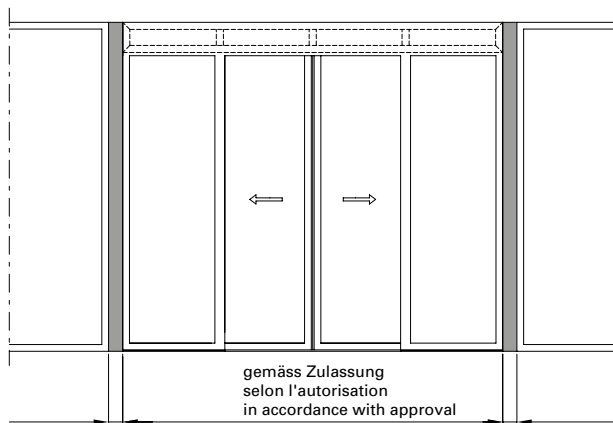
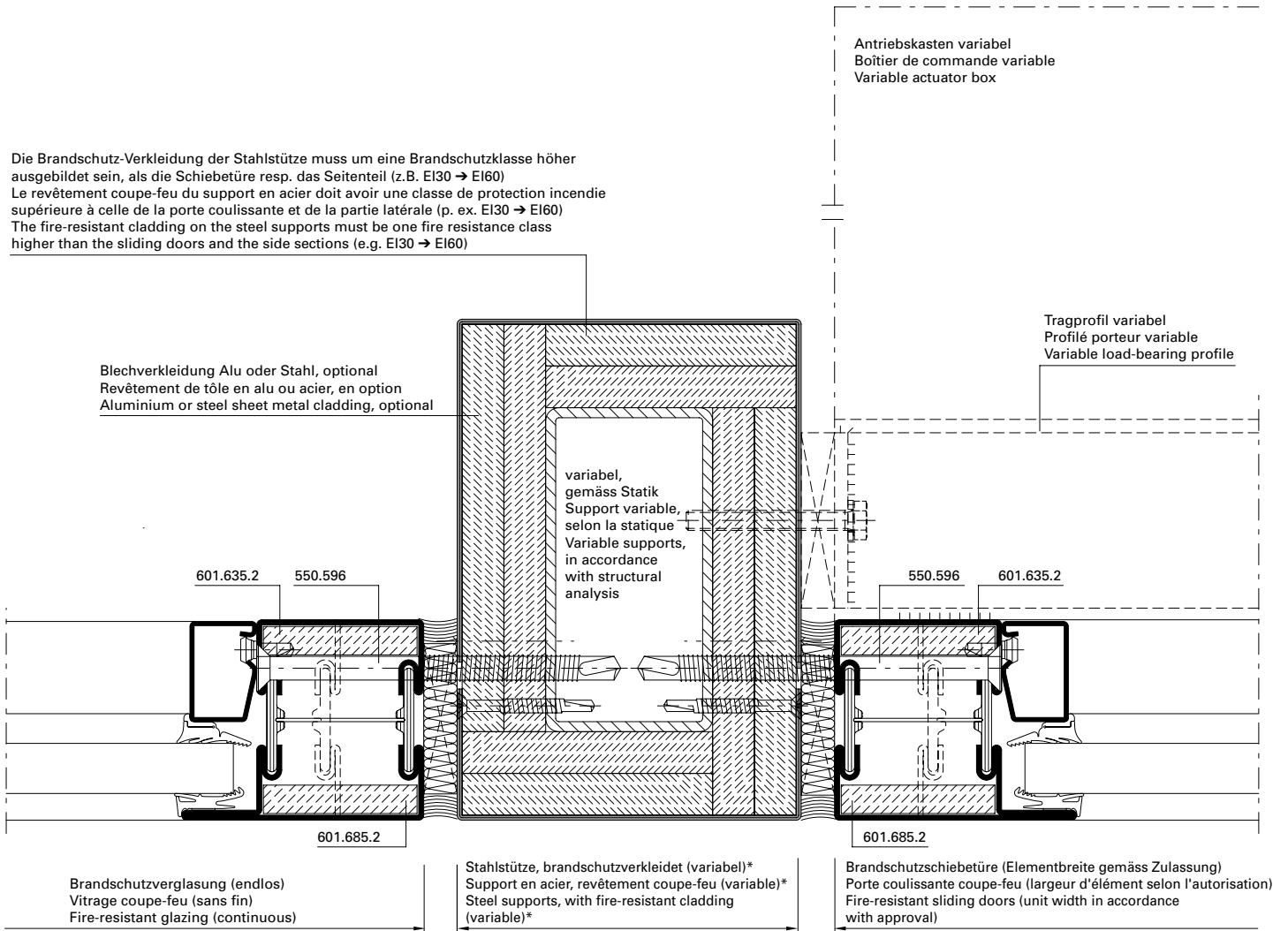

DXF **DWG** 31-0501-A-015

* Brandschutz-Verkleidung entsprechend
 Vorschrift Feuerpolizei resp.
 Fabrikat-Zulassung

* Revêtement coupe-feu selon les
 prescriptions de la police du feu et de
 l'autorisation du produit

* Fire-resistant cladding in accordance with
 the regulations of the fire authorities and
 the manufacturer's approval

Anschluss an verglaste
Brandschutz-Seitenteile/Endloswand

Raccordement à des parties latérales
coupe-feu vitrées/à la paroi à
largeur illimitée

Attachment to glazed fire-resistant
side sections/continuous wall

Die Brandschutz-Verkleidung der Stahlstütze muss um eine Brandschutzklasse höher ausgebildet sein, als die Schiebetüre resp. das Seitenteil (z.B. EI30 → EI60)
 Le revêtement coupe-feu du support en acier doit avoir une classe de protection incendie supérieure à celle de la porte coulissante et de la partie latérale (p. ex. EI30 → EI60)
 The fire-resistant cladding on the steel supports must be one fire resistance class higher than the sliding doors and the side sections (e.g. EI30 → EI60)

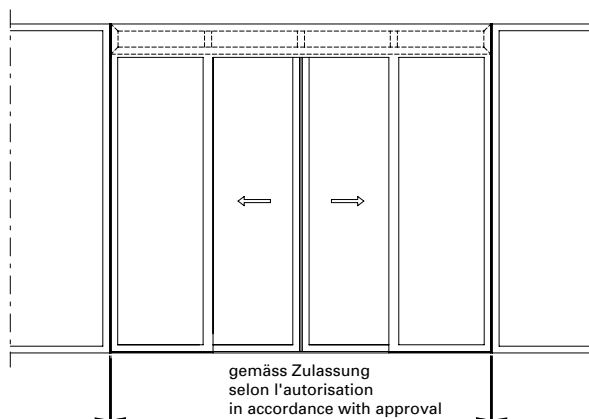
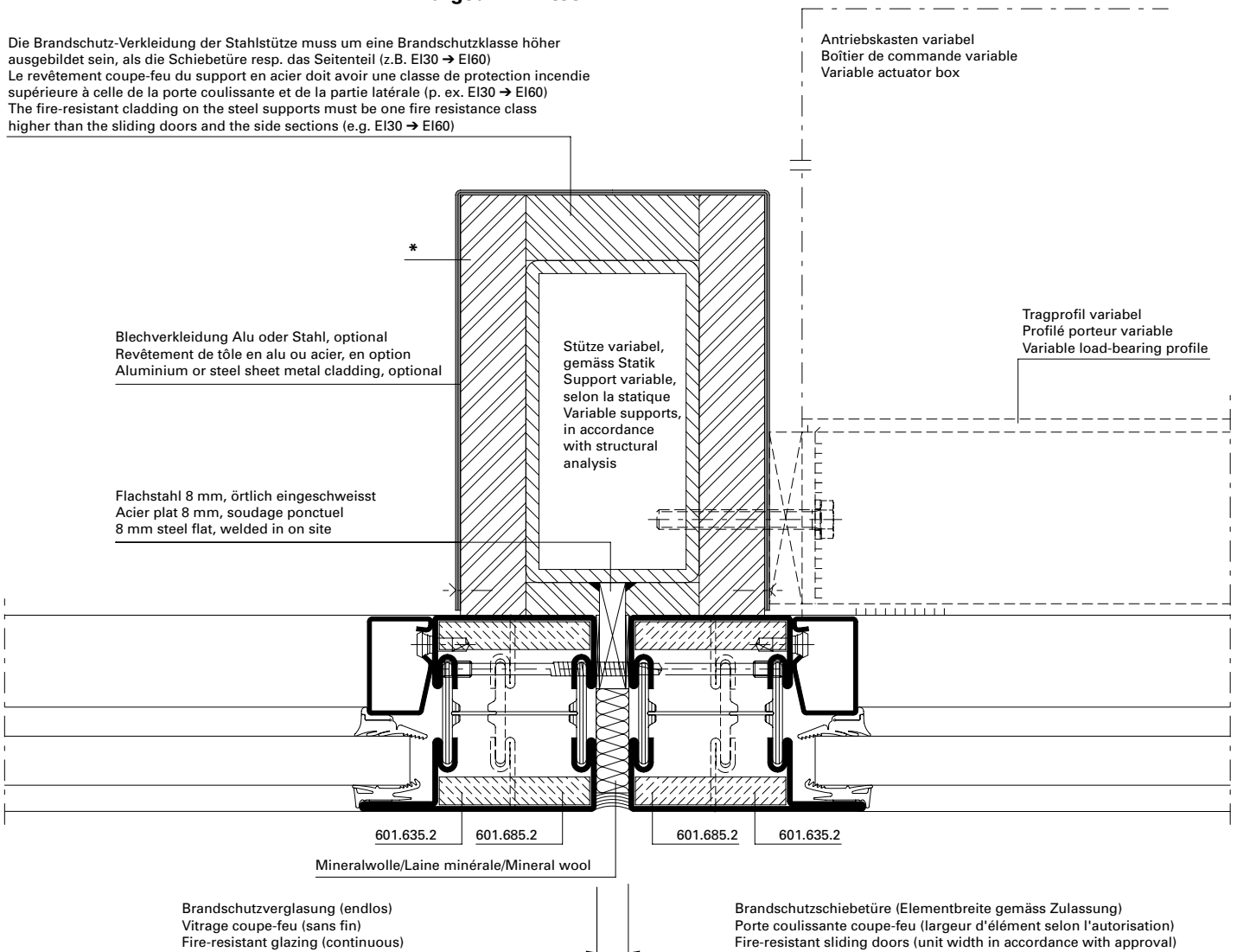

DXF **DWG** 31-0501-A-014

* Brandschutz-Verkleidung entsprechend
 Vorschrift Feuerpolizei resp.
 Fabrikat-Zulassung

* Revêtement coupe-feu selon les
 prescriptions de la police du feu et de
 l'autorisation du produit

* Fire-resistant cladding in accordance with
 the regulations of the fire authorities and
 the manufacturer's approval

Brandschutzschiebetüre EI30
Porte coulissante coupe-feu EI30
Fire-resistant sliding door EI30
