

Janisol Türen

Wärmegeämmte Türen aus Stahl und Edelstahl

Portes Janisol

Portes en acier et acier Inox à rupture de pont thermique

Janisol doors

Thermally insulated doors in steel and stainless steel

Inhaltsverzeichnis
Sommaire
Content

Janisol Türen
Janisol portes
Janisol doors

Systemübersicht

Merkmale
Leistungseigenschaften
Systemausführungen
Typenübersicht

Sommaire du système

Caractéristiques
Caractéristiques de performance
Exécutions de système
Sommaire des types

Summary of system

Characteristics
Performance characteristics
System versions
Summary of types

2

Profilsortiment in Stahl und Edelstahl

Assortiment de profilé en acier et acier Inox

Range of profiles in steel and stainless steel

12

Beispiele

Schnittpunkte
Konstruktionsdetails
Anschlüsse am Bau

Exemples

Coupes de détails
Détails de construction
Raccords au mur

Examples

Section details
Construction details
Attachment to structure

18

Leistungseigenschaften

Caractéristiques de performance

Performance characteristics

50

Alle Ausführungen dieser Dokumentation haben wir sorgfältig und nach bestem Wissen zusammengestellt. Wir können aber keine Verantwortung für die Benutzung der vermittelten Vorschläge und Daten übernehmen. Wir behalten uns technische Änderungen ohne Vorankündigung vor.
Aktuelle Version auf www.jansen.com

Nous avons apporté le plus grand soin à l'élaboration de cette documentation. Cependant, nous déclinons toute responsabilité pour l'utilisation faite de nos propositions et de nos données.
Nous nous réservons le droit de procéder à des modifications techniques sans préavis.
Version actuelle sur www.jansen.com

All the information contained in this documentation is given to the best of our knowledge and ability. However, we decline all responsibility for the use made of these suggestions and data.
We reserve the right to effect technical modifications without prior warning.
Current version available at www.jansen.com

Janisol Türen

- Wärme gedämmtes Stahlsystem für Türen und Festverglasungen
- Bautiefe 60 mm, innen und aussen flächenbündig
- Schmale Ansichtsbreiten: Rahmen und Flügel ab 107,5 mm Stulppartie 155 mm
- Ein- und zweiflüglige Türen, nach innen und aussen öffnend, mit Oberlicht oder Festverglasung kombinierbar
- Türflügel bis 1465 x 3000 mm (BxH), Flügelgewicht bis 230 kg
- Füllelementstärke von 15 bis 37 mm, Glaseinbau mittels Trocken- oder Nassverglasung
- Systemprüfungen nach Produktnorm EN 14351-1
- Profil-Verbundtechnik nach EN 14024 geprüft
- Festigkeitsanforderung nach EN 1192 (Klasse 4)
- Stahlprofile blank oder bandverzinkt, qualitativ hochwertiger Isoliersteg aus glasfaserverstärktem Polyester
- Grosses Sortiment an systemgeprüften Türbeschlägen
- Barrierefreie Schwellenausbildungen
- Geeignet für Pulver- und Nasslackbeschichtungen

Janisol portes







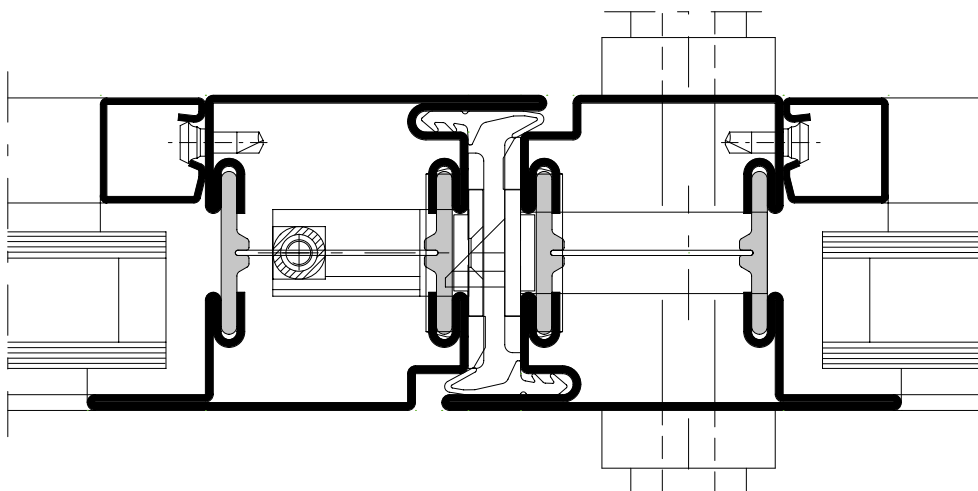

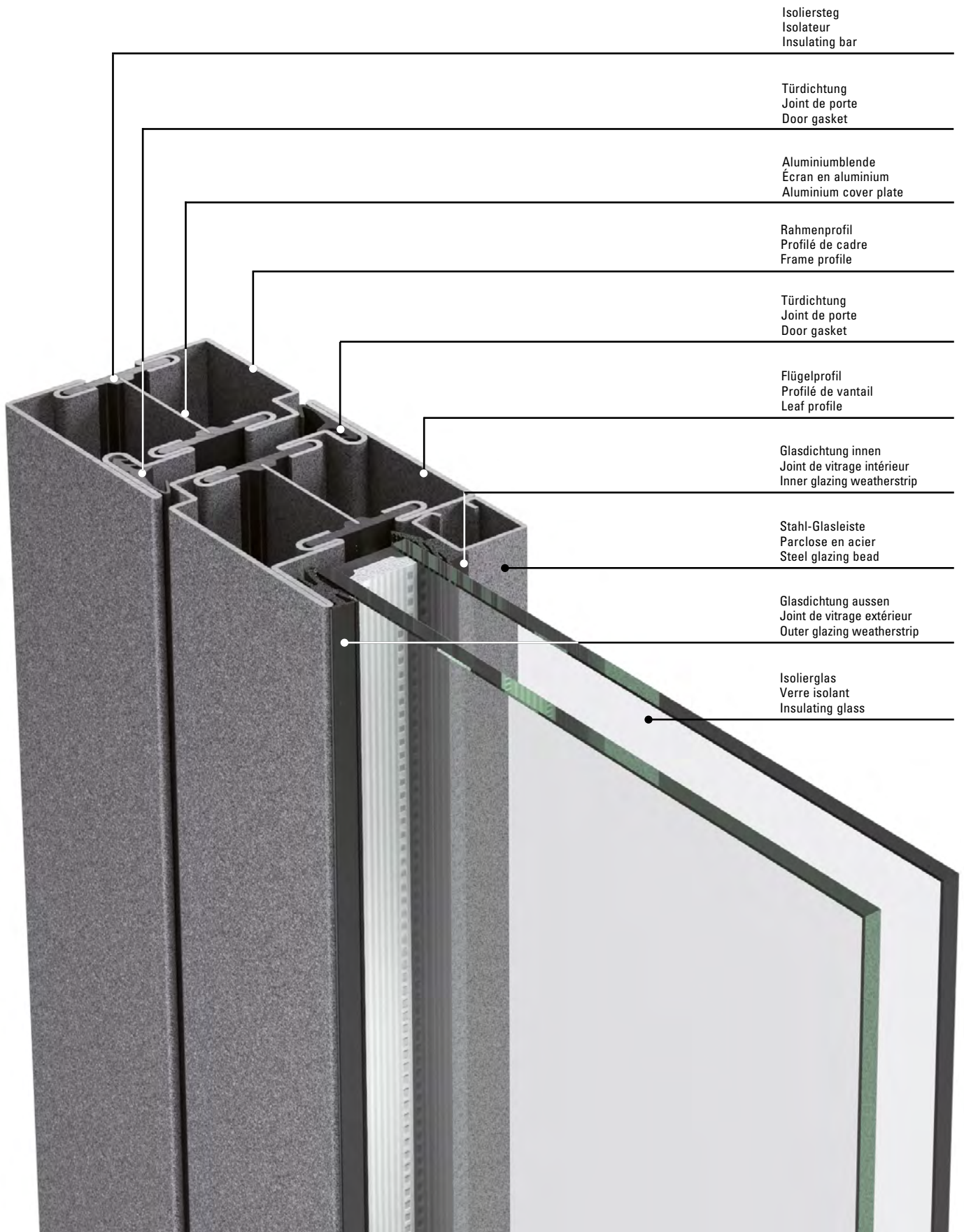



- Système en acier à rupture de pont thermique pour portes et vitrages fixes
- Profondeur de montage 60 mm, montage à fleur à l'intérieur et à l'extérieur
- Fines largeurs de face: Cadre et vantaux à partir de 107,5 mm Partie tête 155 mm
- Portes à un et deux vantaux, ouverture vers l'intérieur et vers l'extérieur, combinables avec imposte ou vitrage fixe
- Vantaux de porte jusqu'à 1465 x 3000 mm (LaxH), poids du vantail jusqu'à 230 kg
- Élément de remplissage de 15 à 37 mm d'épaisseur, Montage du vitrage à sec ou à silicone
- Contrôles des systèmes selon la norme produit EN 14351-1
- Technique d'assemblage de profilés contrôlée selon EN 14024
- Exigence de résistance selon EN 1192 (classe 4)
- Profilés en acier brut ou galvanisé en continu, traverse isolante de grande qualité en polyester renforcé par fibres de verre
- Grand assortiment de ferrures de porte homologuées
- Formes de seuil sans barrière
- Convient aux revêtements par poudre ou peinture liquide

Janisol doors

- Thermally insulated steel system for doors and fixed glazing
- 60 mm basic depth, flush-fitted on the inside and outside
- Narrow face widths: Frame and leaf from 107.5 mm Meeting stile assembly 155 mm
- Single and double-leaf doors, inward and outward-opening, can be combined with toplight or fixed glazing
- Door leaf up to 1465 x 3000 mm (WxH), leaf weight up to 230 kg
- Infill unit thickness of 15 to 37 mm, Glazing installed by means of dry or wet glazing
- System tests in accordance with the product standard EN 14351-1
- Profile bonding technology tested in accordance with EN 14024
- Strength requirements in accordance with EN 1192 (Class 4)
- Raw finish or pre-galvanised steel profiles, high-quality insulating bar made of glass fibre-reinforced polyester
- Large range of system-tested door fittings
- Easy-access thresholds
- Suitable for powder and wet paint coating





Norm	Eigenschaft Caractéristique Characteristic	Klassifizierung/Wert Classification / Valeur Classification / Value										
 EN 12210	Widerstandsfähigkeit bei Windlast Résistance à la pression du vent Resistance to wind load	npd	1 (400)	2 (800)	3 (1200)	4 (1600)	5 (2000)	Exxx (>2000)				
 EN 12208	Schlagregendichtheit Étanchéité à la pluie battante Watertightness	npd	1A (0)	2A (50)	3A (100)	4A (150)	5A (200)	6A (250)	7A (300)	8A (450)	9A (600)	Exxx (>750)
 EN ISO 10140	Schalldämmung R_w (C, C_{tr}) (dB) Isolation phonique R_w (C, C_{tr}) (dB) Sound insulation R_w (C, C_{tr}) (dB)	npd	bis R_w 45 dB (-2; -5) jusqu'à R_w 45 dB (-2; -5) up to R_w 45 dB (-2; -5)									
 EN ISO 10077-2	Wärmedurchgangskoeffizient U_f (W/(m ² ·K)) Transmission thermique U_f (W/(m ² ·K)) Thermal production U_f (W/(m ² ·K))	npd	ab 1.5 W/m ² K à partir de 1.5 W/m ² K from 1.5 W/m ² K									
 EN 12207	Luftdurchlässigkeit Perméabilité à l'air Air permeability	npd	1 (150)	2 (300)	3 (600)	4 (600)						
 EN 1192	Klassifizierung der Festigkeitsanforderungen Classification des exigences de résistance méca. Classification of strength requirements	npd	1	2	3	4						
 EN 12219	Differenzklimaverhalten Résistance aux changements de température Resistance to change in temperature	npd	bis / jusqu'à / up to 3(d) / 3(e) Technische Hinweise / Conseils techniques / Technical data: «Verhalten zwischen unterschiedlichen Klimaten nach EN 1121» «Comportement entre différents climats selon EN 1121» «Behaviour between different climates in accordance with EN 1121»									
 EN 1627	Einbruchhemmung Anti-effraction Burglar resistance	npd	1	2	3	4	5	6				
 EN 1522	Durchschusshemmung Résistance aux balles Bullet proofing	npd	FB1	FB2	FB3	FB4	FB5	FB6	FB7	FSG		
 EN 14024	Metallprofile mit thermischer Trennung Profils en métal. avec rupture de pont thermique Metal profiles with thermal barrier		CW / TC2									
 EN 12400	Dauerfunktionsprüfung Durabilité mécanique Mechanical durability	D	1 5'000	2 10'000	3 20'000	4 50'000	5 100'000	6 200'000	7 500'000	8 1'000'000		
 EN 12217	Bedienkräfte Forces de manœuvre Operating forces	npd	0			1		2				



Janisol Türen Edelstahl

- Wärmegedämmtes Edelstahlsystem für Türen und Festverglasungen
- Bautiefe 60 mm, innen und aussen flächenbündig
- Schmale Ansichtsbreiten, Rahmen inkl. Flügel ab 107.5 mm, Stulppartie 155 mm
- Edelstahlprofile aus Werkstoff 1.4301 (AISI 304) oder 1.4401 (AISI 316) geeignet für Industrie und Küstennähe
- Ausführung blank oder geschliffen (Korn 220-240)

Janisol portes acier Inox

- Système en acier Inox à rupture de pont thermique pour portes et vitrages fixes
- Profondeur de montage 60 mm, montage à fleur à l'intérieur et à l'extérieur
- Fines largeurs de face: Cadre et vantaux à partir de 107,5 mm, partir tête 155 mm
- Profilés en acier Inox en matériau 1.4301 (AISI 304) ou 1.4401 (AISI 316), conviennent aux zones industrielles et à proximité des côtes
- Exécution brut ou polie (grain 220 à 240)

Janisol stainless steel doors

- Thermally insulated stainless steel system for doors and fixed glazing
- 60 mm basic depth, flush-fitted on the inside and outside
- Narrow face widths: Frame and leaf from 107.5 mm, meeting stile assembly 155 mm
- Stainless steel profiles made from the material 1.4301 (AISI 304) or 1.4401 (AISI 316) suitable for industrial and coastal areas
- Execution bright or polished (grain 220-240)

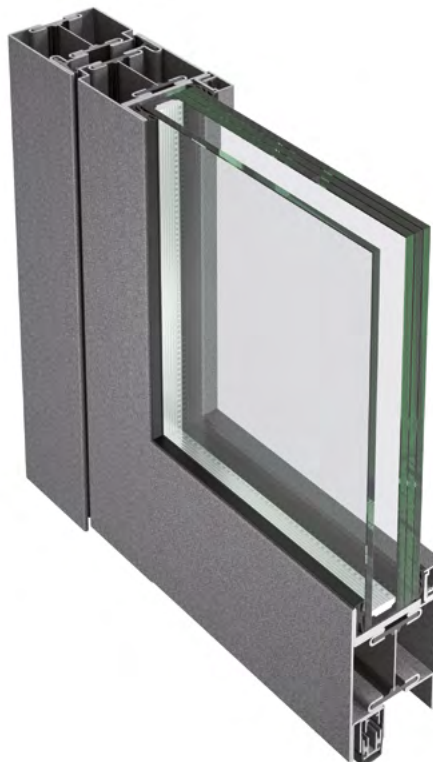

Einbruchhemmende Janisol Türen

- Türgrößen bis 1465 x 3000 mm
- Ein- und zweiflüglige Türen, nach innen und aussen öffnend
- Ausführung in Stahl oder Edelstahl
- Prüfungen nach EN 1627 bis 1630 bis RC3 inkl. Panikfunktion

Portes anti-effraction Janisol

- Dimensions de porte jusqu'à 1465 x 3000 mm
- Portes à un/deux vantaux à ouverture vers l'intérieur et l'extérieur
- Exécution en acier ou en acier Inox
- Contrôlé selon les normes EN 1627 à 1630 jusqu'à RC3, avec fonction panique

Burglar-resistant Janisol doors

- Door sizes up to 1465 x 3000 mm
- Single and double-leaf doors, inward and outward-opening
- Available in steel or stainless steel
- Test in accordance with EN 1627 to 1630 to RC3 including panic function



Durchschusshemmende Janisol Türen FB 4-6

- Türgrößen bis 1465 x 3000 mm
- Ein- und zweiflüglige Türen, nach innen und aussen öffnend
- Geprüft nach EN 1522

Portes pare-balles Janisol FB 4-6

- Dimensions de porte jusqu'à 1465 x 3000 mm
- Portes à un/deux vantaux à ouverture vers l'intérieur et l'extérieur
- Contrôlé selon la norme EN 1522

Bullet-resistant Janisol doors FB 4-6

- Door sizes up to 1465 x 3000 mm
- Single and double-leaf doors, inward and outward-opening
- Tested in accordance with EN 1522



Janisol Fingerschutzüren

- Keine Quetsch- und Scherstellen nach DIN 18650
- Wartungsarme Bandlager unten und oben
- Geeignet für Gebäude mit starkem Publikumsverkehr
- Geprüft nach EN 14351-1

Portes anti-pince-doigts Janisol

- Absence de zones d'écrasement et de cisaillement selon DIN 18650
- Paliers de paumelle inférieur et supérieur exigeant peu de maintenance
- Adapté à des bâtiments publics fortement fréquentés
- Contrôlé selon la norme EN 14351-1

Janisol anti-finger-trap doors

- No crushing and shearing points as per DIN 18650
- Low-maintenance hinge bush at top and bottom
- Suitable for buildings subject to frequent use by the public
- Tested in accordance with EN 14351-1



Verblechte Janisol Türen

- Flächenbündig verblechte Türen
- Geschweisst oder geklebt
- nach innen und aussen öffnend
- mit Glasausschnitt möglich

Portes tôlées Janisol

- Portes tôlées à fleur
- Soudées ou collées
- Ouverture vers l'intérieur et l'extérieur
- Panneau de verre possible

Janisol sheet metal doors

- Flush-fitted sheet metal doors
- Welded or bonded
- Inward and outward-opening
- Can have glass vision panel



Fluchttürsysteme

- Verschlussystem für Notausgangstüren nach EN 179
- Verschlussystem für Paniktüren nach EN 1125
- Barrierefreie Türen ohne Schwelle für behindertengerechtes Bauen
- Ein- und zweiflügelige Türen nach aussen und nach innen öffnend
- Türflügelgrössen bis 1465 x 3000 mm und Flügelgewicht bis 230 kg

Systèmes de porte de secours

- Système de fermeture pour portes de secours selon EN 179
- Système de fermeture pour portes panique selon EN 1125
- Portes sans seuil pour faciliter l'accès aux personnes handicapées
- Portes à un/deux vantaux à ouverture vers l'intérieur et l'extérieur
- Dimensions de vantail de porte jusqu'à 1465 x 3000 mm et poids de vantail jusqu'à 230 kg

Emergency exit systems

- Closing system for emergency exit doors in accordance with EN 179
- Closing system for panic doors in accordance with EN 1125
- Barrier-free doors without threshold for accessible buildings
- Single and double-leaf doors, outward and inward-opening
- Door leaf sizes up to 1465 x 3000 mm and leaf weight up to 230 kg

Jansen Docu Center

Die Plattform zum effizienten Arbeiten mit Jansen Dokumentationen. Im Jansen Docu Center stehen alle Produktinformationen jederzeit digital in der aktuellsten Version zur Verfügung: von Architekten-Informationen über Bestell- und Fertigungskatalogen bis hin zu Anleitungen und Prospekten sowie Videos.

Die Inhalte können einfach und schnell aufgerufen werden. Ein für den Anwender komfortables papierloses Arbeiten, das zahlreiche Vorteile bietet.

Download CAD Daten

DXF

DWG

Sie können die Zeichnungen in den Formaten DXF und/oder DWG herunterladen. Klicken Sie auf das entsprechende Icon und der Download erfolgt.

Die Hinweise «Artikelbibliothek/Türbeschläge/Fensterbeschläge» bedeuten, dass Sie mit einem Klick die gesamte Artikelbibliothek des entsprechenden Systems herunterladen (Profile, Beschläge, Glasleisten, Zubehör etc.).

Info und Beratung

Gerne beraten wir Sie persönlich und stehen Ihnen bei Fragen zur Verfügung. Bitte schreiben Sie uns Ihre Anliegen an: info@jansen.com

Jansen Docu Center

La plate-forme pour travailler efficacement avec les documentations Jansen. Le Jansen Docu Center met à votre disposition les informations sur les produits, en format numérique et dans une version actualisée: des catalogues de commande et de fabrication aux instructions et prospectus, en passant par les informations destinées aux architectes et vidéos.

Les contenus sont facilement et rapidement accessibles. Une manière de travailler confortable et offrant de nombreux avantages.

Télécharger fichiers DAO

DXF

DWG

Vous pouvez télécharger les dessins aux formats DXF et/ou DWG. Cliquez sur l'icône correspondante et le téléchargement s'effectuera.

Les indications «Bibliothèque des articles/Ferures de porte/Ferrures de fenêtres» signifie que vous téléchargez la totalité de la bibliothèque des articles du système donné (profilés, ferrures, parcloles, accessoires etc.).

Info et conseils

Nous vous conseillerons volontiers individuellement et sommes à votre disposition si vous avez des questions à poser. Veuillez nous envoyer votre requête à: info@jansen.com

Jansen Docu Center

The platform for working efficiently with Jansen documentation. The latest version of all the product information is available digitally at any time in the Jansen Docu Center – from order and fabrication manuals to architect information, instructions and brochures and videos.

The content can be retrieved quickly and easily. The user can work conveniently without paper, which has numerous benefits.

Download CAD files

DXF

DWG

You can download the drawings in DXF and/or DWG format. Click on the relevant icon to begin the download.

The items «Article library/Door fittings/Window fittings» means that you download the entire article library for the corresponding system with one click (profiles, fittings, glazing beads, accessories etc.).

Information and advice

We would be delighted to provide you with advice in person and are available to answer any questions you may have. Please write to us with your queries at: info@jansen.com

Technische Daten
Données techniques
Technical data

Janisol Türen
 Janisol portes
 Janisol doors

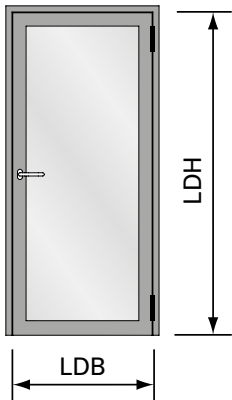

Elementgrößen
(Empfehlung für CE-Kennzeichen)

LDB Lichte Durchgangsbreite
 max. 1425 mm
 min. 600 mm

LDH Lichte Durchgangshöhe
 max. 2985 mm
 min. 1900 mm

Flügelgewicht max. 230 kg

Dimensions des éléments
(Recommandation pour le label CE)

LDB Largeur libre de passage
 max. 1425 mm
 min. 600 mm

LDH Hauteur libre de passage
 max. 2985 mm
 min. 1900 mm

Poids de vantail max. 230 kg

Size of elements
(Recommendation for CE marking)

LDB Inside width
 max. 1425 mm
 min. 600 mm

LDH Inside height
 max. 2985 mm
 min. 1900 mm

Weight of leaf max. 230 kg

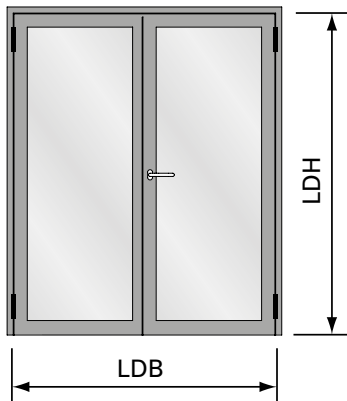

Elementgrößen
(Empfehlung für CE-Kennzeichen)

LDB Lichte Durchgangsbreite
 max. 2870 mm
 min. 1200 mm

LDH Lichte Durchgangshöhe
 max. 2985 mm
 min. 1900 mm

Flügelgewicht max. 230 kg

Dimensions des éléments
(Recommandation pour le label CE)

LDB Largeur libre de passage
 max. 2870 mm
 min. 1200 mm

LDH Hauteur libre de passage
 max. 2985 mm
 min. 1900 mm

Poids de vantail max. 230 kg

Size of elements
(Recommendation for CE marking)

LDB Inside width
 max. 2870 mm
 min. 1200 mm

LDH Inside height
 max. 2985 mm
 min. 1900 mm

Weight of leaf max. 230 kg

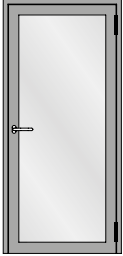

Einflügelige Türe
Porte à un vantail
Single leaf door

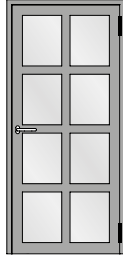

Einflügelige Türe mit Riegel
Porte à un vantail avec traverses
Single leaf door with transoms

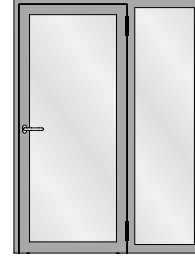

Einflügelige Türe mit festem Seitenteil
Porte à un vantail avec partie latérale fixe
Single leaf door with fixed side light

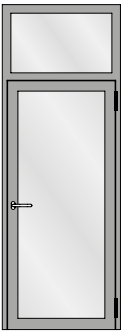

Einflügelige Türe mit festem Oberlicht
Porte à un vantail avec imposte fixe
Single leaf door with fixed top light

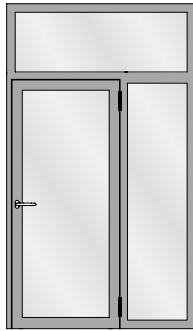

Einflügelige Türe mit festem Seitenteil und festem Oberlicht
Porte à un vantail avec partie latérale fixe et imposte fixe
Single leaf door with fixed side light and fixed top light

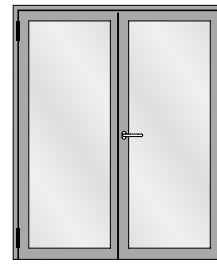

Zweiflügelige Türe
Porte à deux vantaux
Double leaf door



Zweiflügelige Türe mit zwei festen Seitenteilen
Porte à deux vantaux avec deux parties latérales fixes
Double leaf door with two fixed side lights

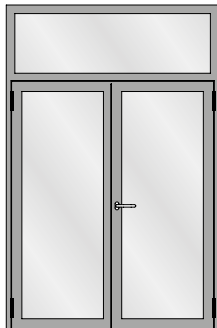

Zweiflügelige Türe mit festem Oberlicht
Porte à deux vantaux avec imposte fixe
Double leaf door with fixed top light

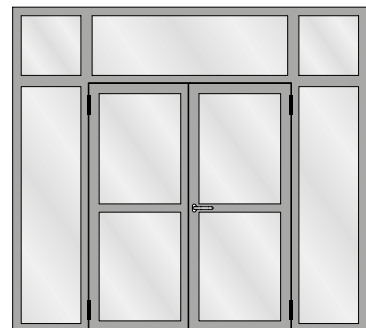

Zweiflügelige Türe mit zwei festen Seitenteilen und festem Oberlichtern
Porte à deux vantaux avec deux parties latérales fixes et impostes fixes
Double leaf door with two fixed side lights and fixed top lights

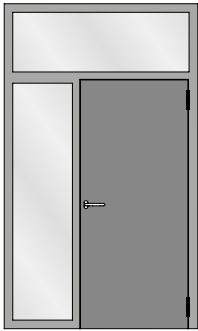

Verblechte Türe mit festem Seitenteil und festem Oberlicht
Porte tôlée à un vantail avec avec partie latérale fixe et imposte fixe
Sheet metal single leaf door with fixed side light and fixed top light



Verblechte zweiflügelige Türe mit zwei festen Seitenteilen und festen Oberlichtern
Porte tôlée à deux vantaux avec deux parties latérales fixes et impostes fixes
Sheet metal double leaf door with two fixed side lights and fixed top lights

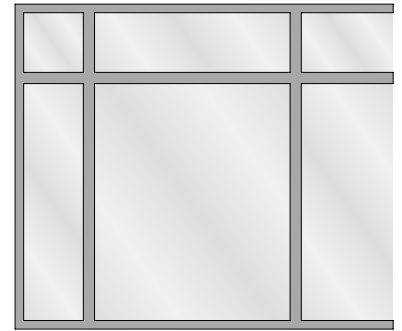

Festverglasung
Vitrage fixe
Fixed glazing

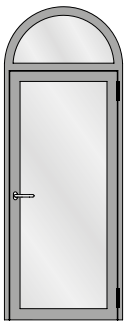

Einflügelige Türe mit Rundbogen-Oberlicht
Porte à un vantail avec imposte demi-ronde
Single leaf door with round arched top light

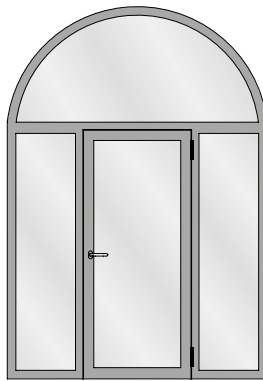

Einflügelige Türe mit zwei festen Seitenteilen und Rundbogen-Oberlicht
Porte à un vantail avec deux parties latérales fixes et imposte demi-ronde
Single leaf door with two fixed side lights and round arched top light

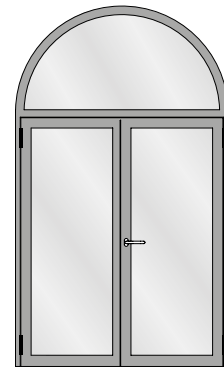

Zweiflügelige Türe mit Rundbogen-Oberlicht
Porte à deux vantaux avec imposte demi-ronde
Double leaf door with round arched top light

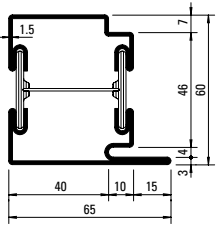

630.013
630.013 Z
 630.013.01

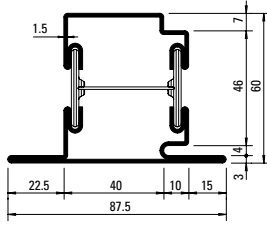

630.114
630.114 Z
 630.114.01

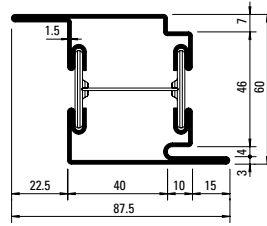

630.416
630.416 Z
 630.416.01

Artikelbibliothek
 Bibliothèque des articles
 Article library

DXF **DWG**

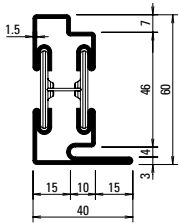

630.010
630.010 Z

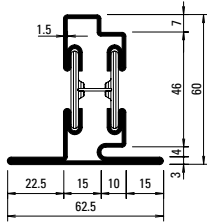

630.110
630.110 Z

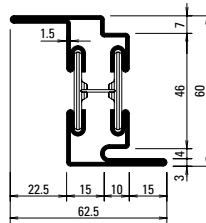

630.411
630.411 Z

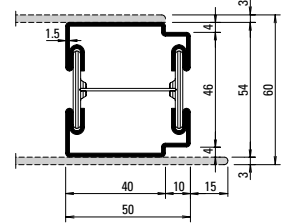

600.010 Z

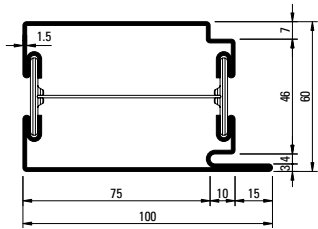

630.016
630.016 Z
 630.016.01

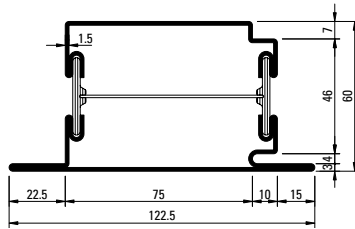

630.115
630.115 Z
 630.115.01

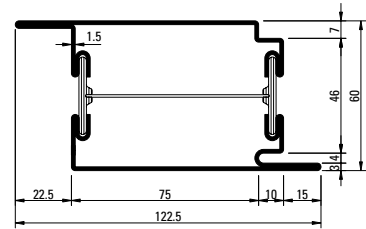

630.417
630.417 Z
 630.417.01

Profil-Nr.	G kg/m	I _x cm ⁴	W _x cm ³	I _y cm ⁴	W _y cm ³	U m ² /m
630.013	4,106	18,41	5,01	18,48	5,09	0,278
630.114	4,623	21,10	5,28	27,18	5,88	0,322
630.416	4,624	23,41	7,22	27,14	5,87	0,322
630.010	3,430	13,12	3,48	4,11	1,63	0,229
630.110	3,943	15,30	3,69	7,79	2,33	0,274

Profil-Nr.	G kg/m	I _x cm ⁴	W _x cm ³	I _y cm ⁴	W _y cm ³	U m ² /m
630.411	3,970	18,18	5,06	7,83	2,34	0,272
630.016	5,008	25,72	7,17	61,11	11,67	0,350
630.115	5,527	28,45	7,35	79,24	12,38	0,394
630.417	5,527	30,64	9,48	80,21	12,53	0,394
600.010 Z	3,388	11,80	4,10	12,98	5,09	0,217

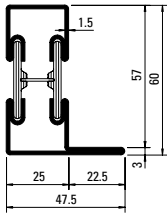

601.635
601.635 Z
601.635.01

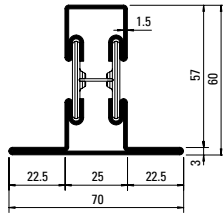

602.635
602.635 Z
602.635.01

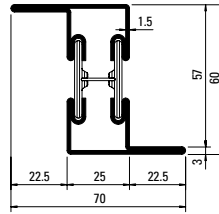

603.635
603.635 Z

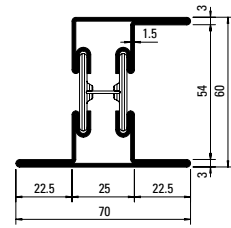

605.635
605.635 Z

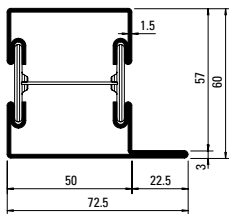

601.685
601.685 Z
601.685.01

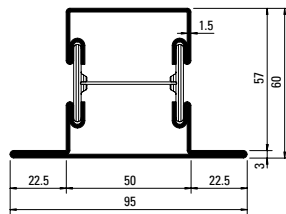

602.685
602.685 Z
602.685.01

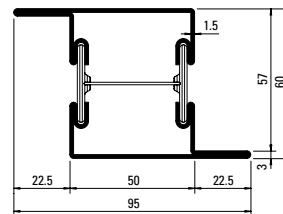

603.685
603.685 Z

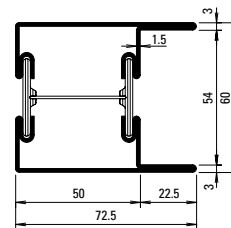

604.685
604.685 Z

Gewichte für Edelstahl-Profile siehe Seite 14
Poids pour profilés en acier Inox voir page 14
Weights for stainless steel profiles see page 14

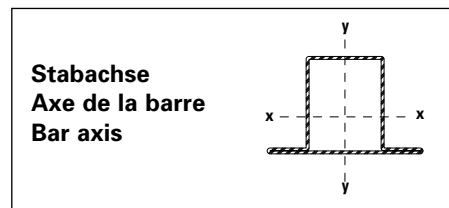

Profil-Nr.	G kg/m	Ix cm ⁴	Wx cm ³	Iy cm ⁴	Wy cm ³	U m ² /m
601.635	3,420	13,88	3,73	5,78	1,87	0,228
602.635	3,940	16,42	4,02	10,01	2,86	0,272
603.635	3,948	18,93	5,92	10,03	2,87	0,271
605.635	4,610	21,93	5,54	30,90	6,51	0,321

Profil-Nr.	G kg/m	Ix cm ⁴	Wx cm ³	Iy cm ⁴	Wy cm ³	U m ² /m
601.685	4,091	19,15	5,27	21,55	5,09	0,277
602.685	4,610	21,93	5,54	30,90	6,51	0,321
603.685	4,611	24,07	7,52	30,90	6,51	0,321
604.685	4,611	24,07	7,52	26,93	7,00	0,321

Profilübersicht
Sommaire des profilés
Summary of profiles

Janisol Türen
 Janisol portes
 Janisol doors

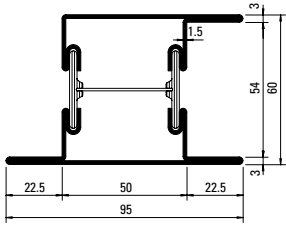

605.685
605.685 Z
605.685.01

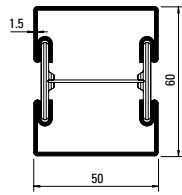

600.005
600.005 Z

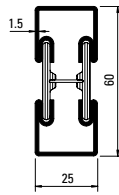

600.006
600.006 Z

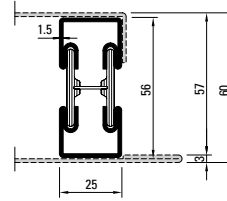

600.002
600.002 Z

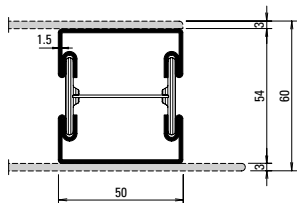

600.007 Z

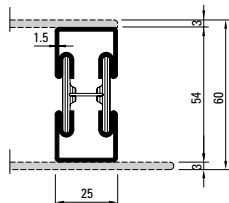

600.008 Z

Profil-Nr.	G kg/m	I _x cm ⁴	W _x cm ³	I _y cm ⁴	W _y cm ³	U m ² /m
605.685	5,130	27,90	7,89	38,23	7,42	0,365
600.002	2,824	8,95	3,00	2,56	2,05	0,174
600.005	3,571	15,45	4,83	14,47	5,79	0,232
600.006	2,893	10,31	3,22	2,70	2,16	0,185
600.007 Z	3,429	12,46	4,33	13,50	5,40	0,220
600.008 Z	2,826	v8,12	2,82	2,57	5,06	0,170

Gewichte für Edelstahl-Profile
Poids pour profilés en acier Inox
Weights for stainless steel profiles

630.013.0x	= 4,173 kg/m
630.114.0x	= 4,690 kg/m
630.416.0x	= 4,705 kg/m
630.016.0x	= 5,085 kg/m
630.115.0x	= 5,630 kg/m
630.417.0x	= 5,630 kg/m
601.635.0x	= 3,477 kg/m
602.635.0x	= 4,029 kg/m
601.685.0x	= 4,138 kg/m
602.685.0x	= 4,663 kg/m
605.685.0x	= 5,193 kg/m

Oberfläche/Werkstoff

Artikel-Nr.

ohne Zusatz = blank

mit Z = bandverzinkter Stahl

Werkstoff 1.4401 (AISI 316)

mit 01 = blank

mit 03 = geschliffen, Korn 220-240

Edelstahl geschliffen auf Anfrage

Surface/Matériau

No. d'article

sans supplément = brut

avec Z = bande d'acier zinguée

Matériau 1.4401 (AISI 316)

avec 01 = brut

avec 03 = polies, grain 220-240

Acier Inox polie sur demande

Surface/Material

Part no.

without addition = bright

with Z = strip galvanised steel

Material 1.4401 (AISI 316)

with 01 = bright

with 03 = polished, grain 220-240

Stainless steel polished on request

Ausgeführte Objekte
Objets réalisés
Completed projects

Janisol Türen
Janisol portes
Janisol doors

Vorarlberger Landesmuseum, Bregenz/AT (Architekt: Cukrowicz Nachbaur Architekten, Bregenz/AT)



Bogentüren
Portes cintrées
Arched doors

Janisol Türen
Janisol portes
Janisol doors

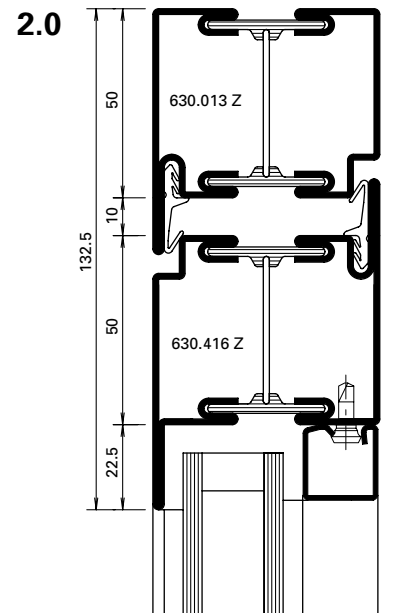
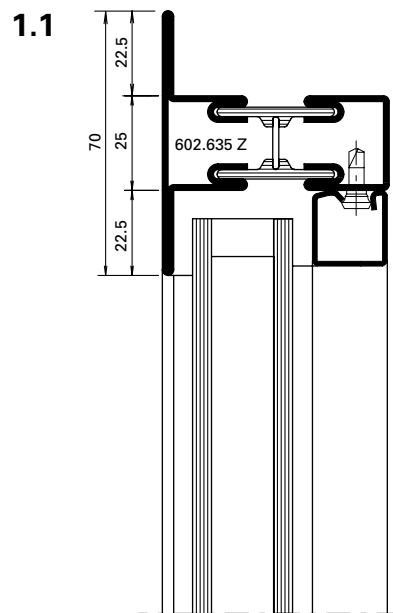
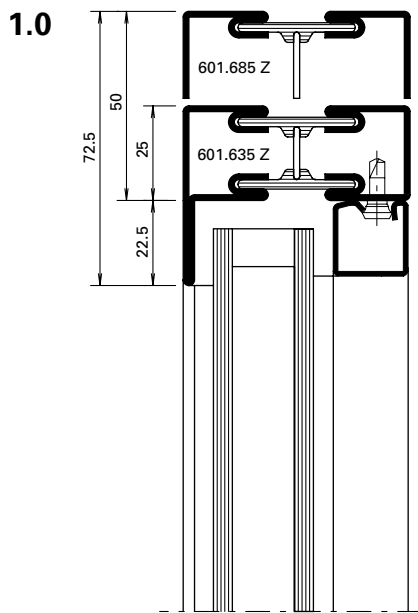
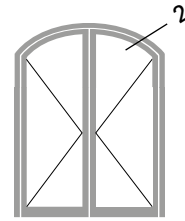
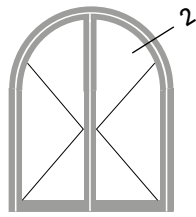
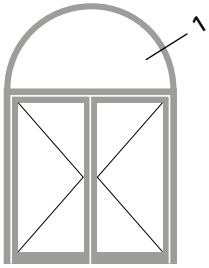

Edelstahl-Profil auf Anfrage!

Die Radien-Angaben beziehen sich auf die Fertigung im Hause Jansen.

Profilés acier Inox sur demande!

Les rayons indiqués concernent la fabrication des cintres par la société Jansen.

Stainless steel profiles on request!

The radius information refers to the production of the arches at the Jansen.

Bogentüren
Portes cintrées
Arched doors

Profil
 Profilé
 Profile

Min. Radius
 Rayon min.
 Min. radius
 R

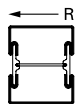

600.002 Z	350 mm
600.005 Z	700 mm
600.006 Z	300 mm
600.007 Z	900 mm
600.008 Z	300 mm
600.010 Z	600 mm

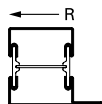

601.635 Z	300 mm
601.685 Z	600 mm

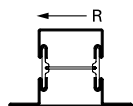

602.635 Z	600 mm
602.685 Z	1100 mm

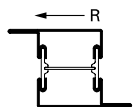

603.635 Z	600 mm
603.685 Z	850 mm

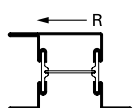

605.635 Z	600 mm
605.685 Z	900 mm

Andere Profiltypen sowie im Grundriss gebogene Profile auf Anfrage.

Bitte benutzen Sie unsere Bestellvorlagen auf extranet.jansen.com

Profil
 Profilé
 Profile

Min. Radius
 Rayon min.
 Min. radius
 R

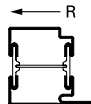

630.010 Z	600 mm
630.013 Z	900 mm

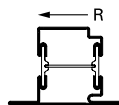

630.110 Z	800 mm
630.114 Z	1000 mm

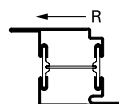

630.411 Z	800 mm
630.416 Z	1300 mm

Autres types de profilés et profilés au tracé cintré sur demande.

Veuillez utiliser nos formulaires de commande sur extranet.jansen.com

Janisol Türen
Janisol portes
Janisol doors

Stahl-Glasleisten
 Parclores en acier
 Steel glazing beads

Min. Radius
 Rayon min.
 Min. radius
 R



402.112 Z	500 mm
402.115 Z	500 mm
402.120 Z	600 mm
402.125 Z	750 mm
402.130 Z	1000 mm

Stahl-Glasleisten
 Parclores en acier
 Steel glazing beads

Min. Radius
 Rayon min.
 Min. radius
 R



62.507 Z	300 mm
62.508 Z	300 mm
62.509 Z	300 mm

Aluminium-Glasleisten
 Parclores en aluminium
 Aluminium glazing beads

Min. Radius
 Rayon min.
 Min. radius
 R



404.112	400 mm
404.115	400 mm
404.120	400 mm
404.125	450 mm
404.130	500 mm
405.115	500 mm
405.120	500 mm
405.125	800 mm
406.903	500 mm
406.905	500 mm
406.907	500 mm
406.909	600 mm

Other profile types and profiles curved in the floor plan are available on request.

Please use our order forms on extranet.jansen.com

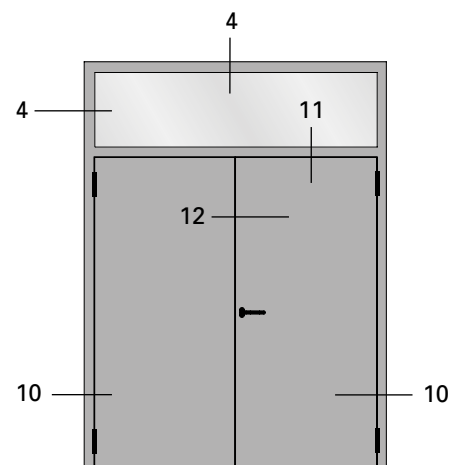
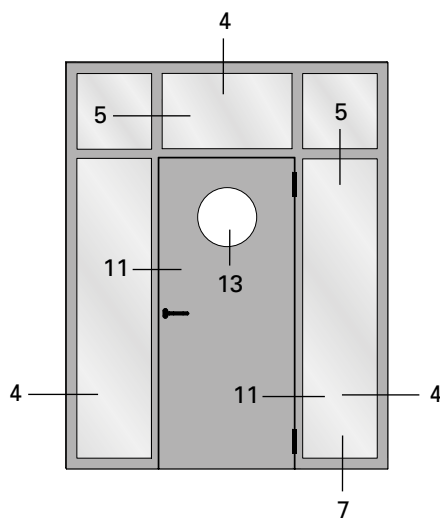
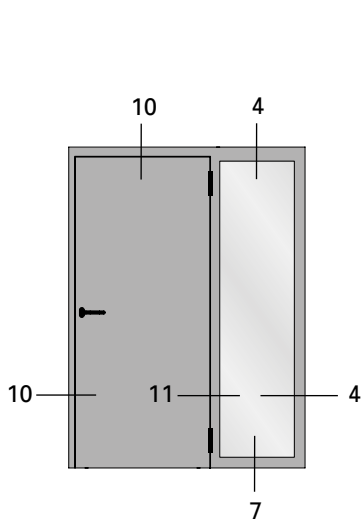
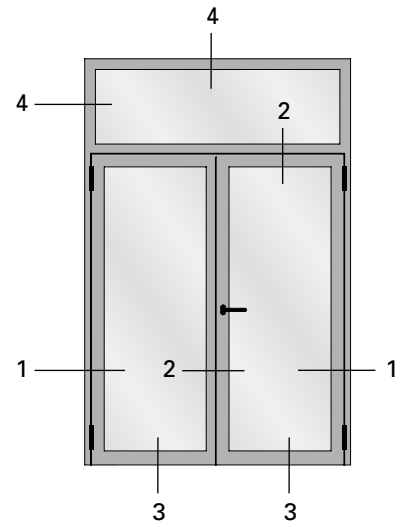
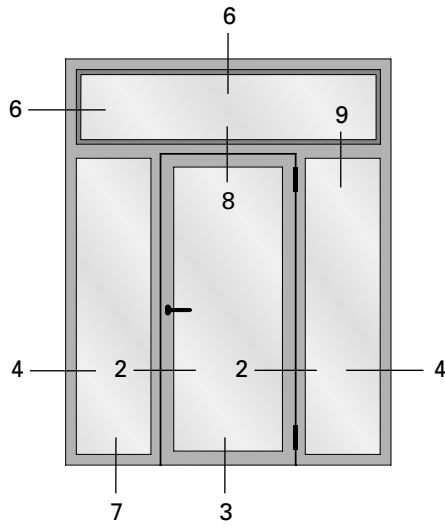
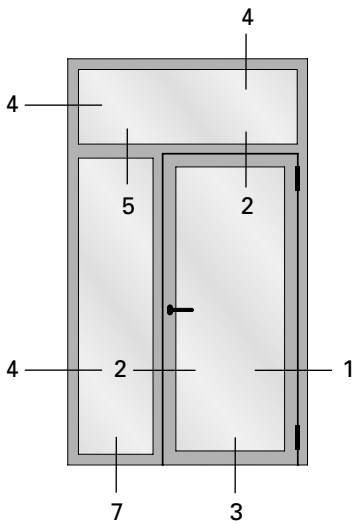
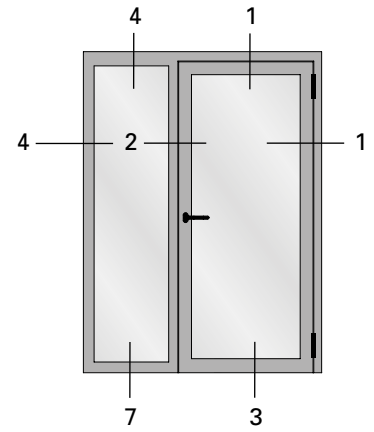
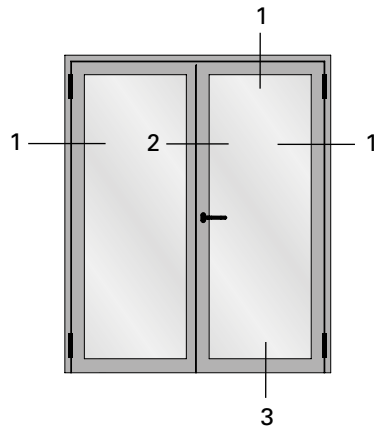
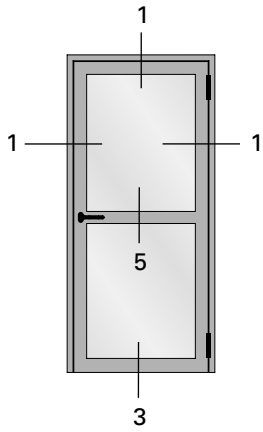

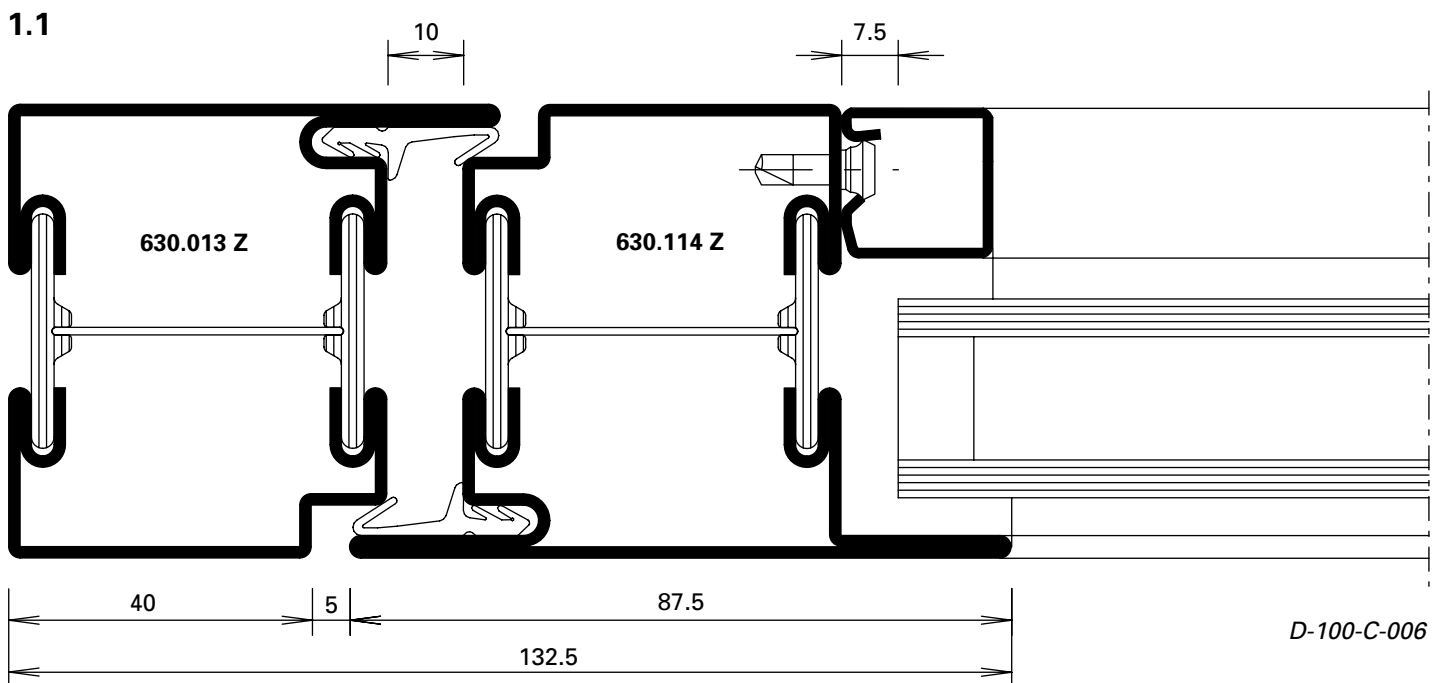
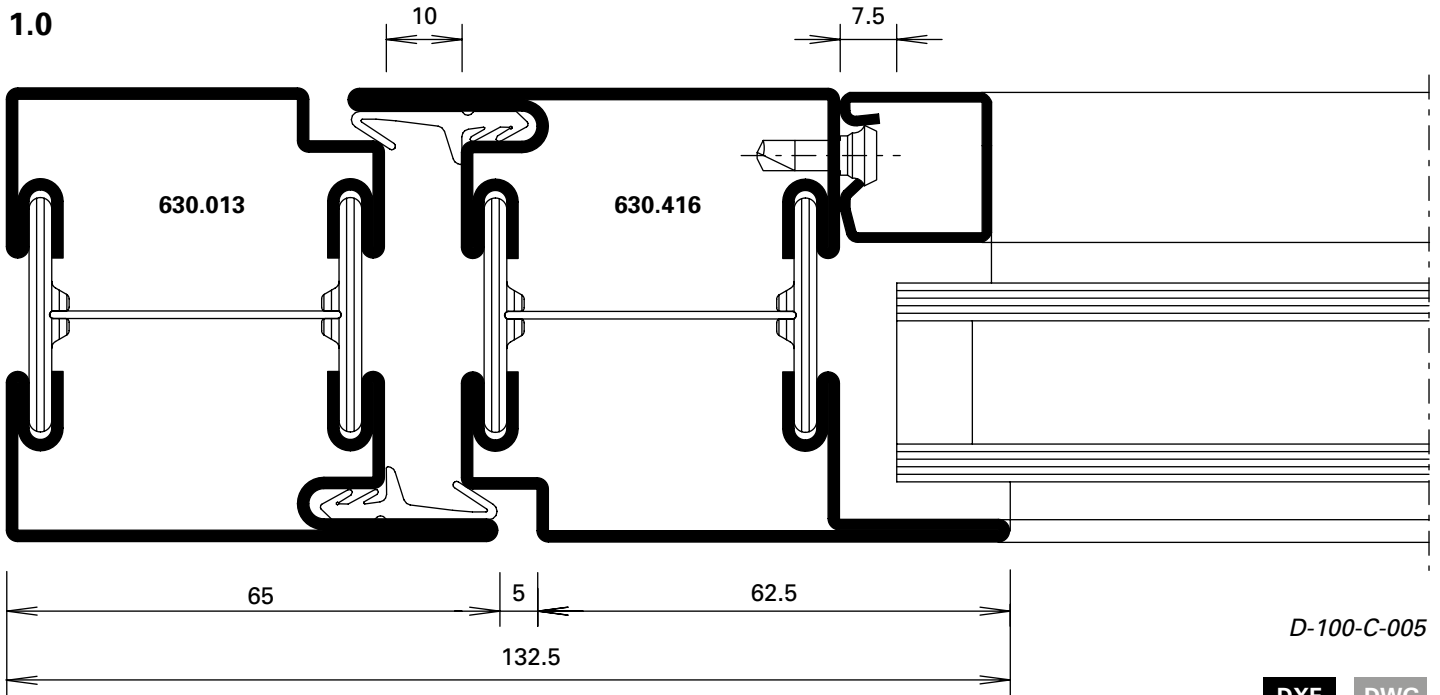

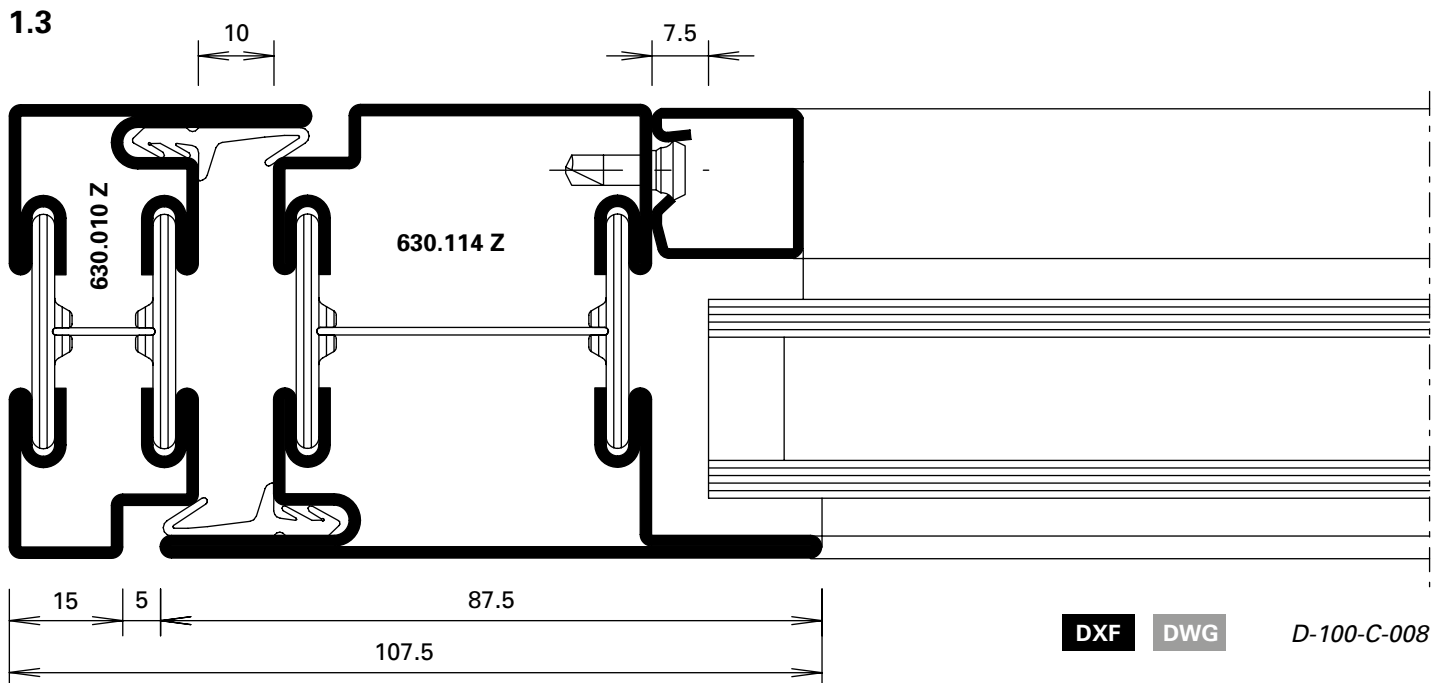
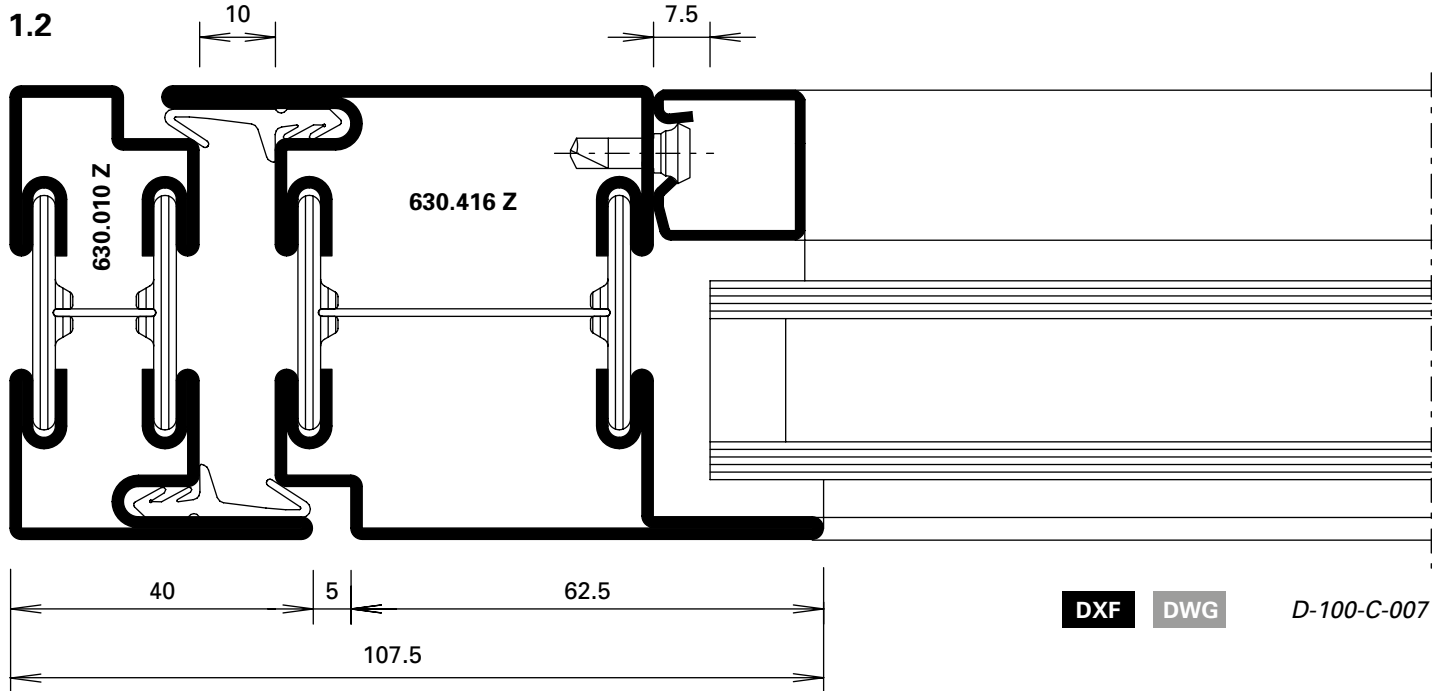

1.4

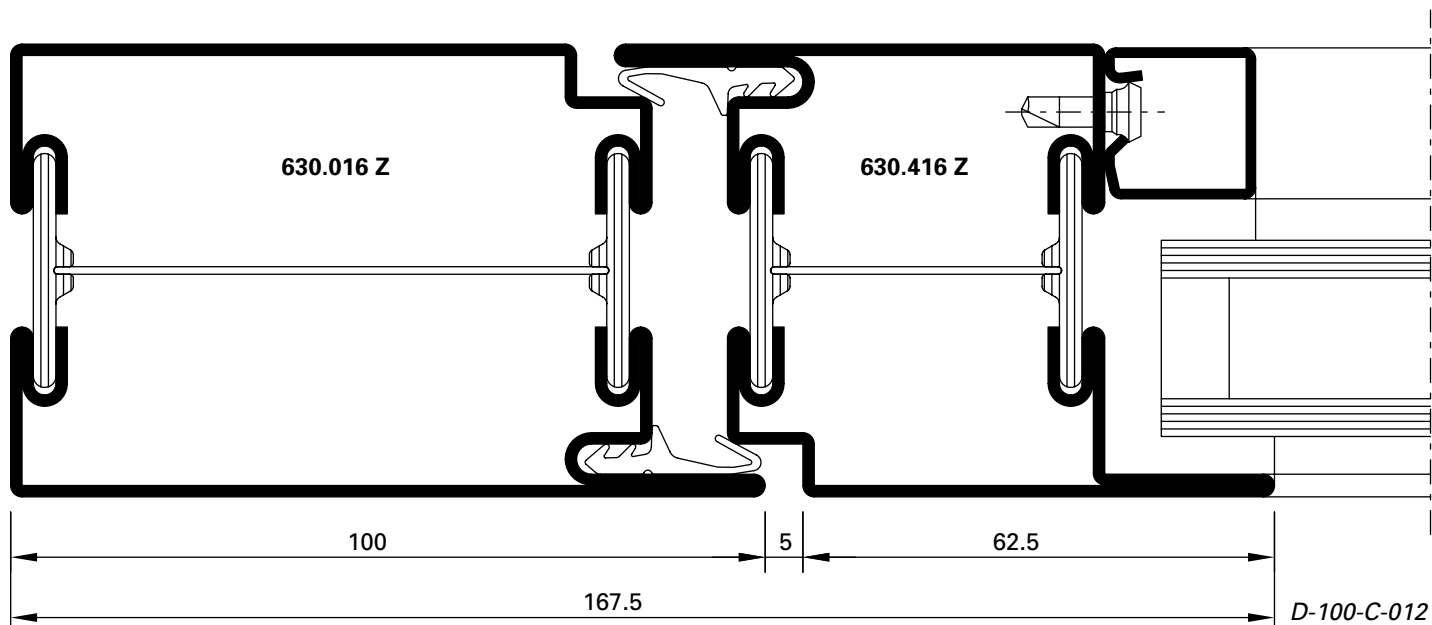

DXF DWG

10.0

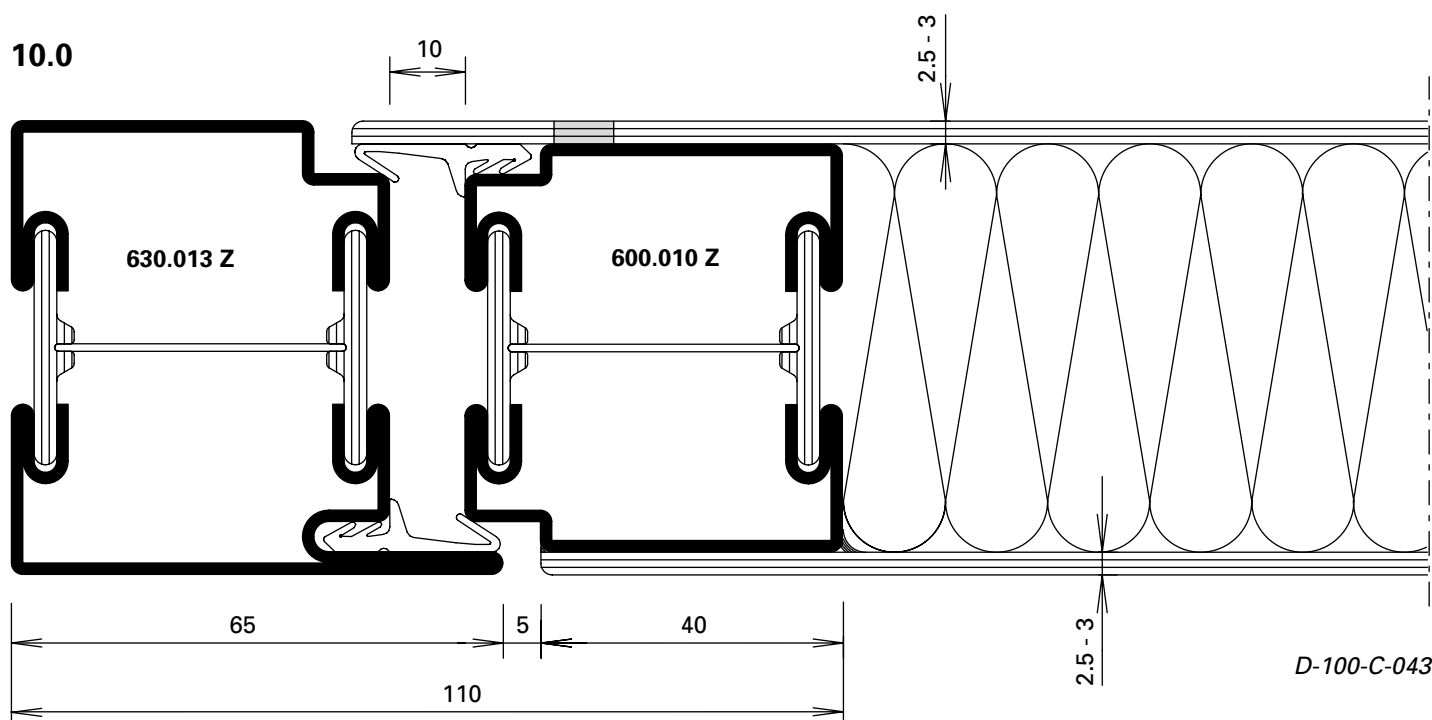

DXF DWG

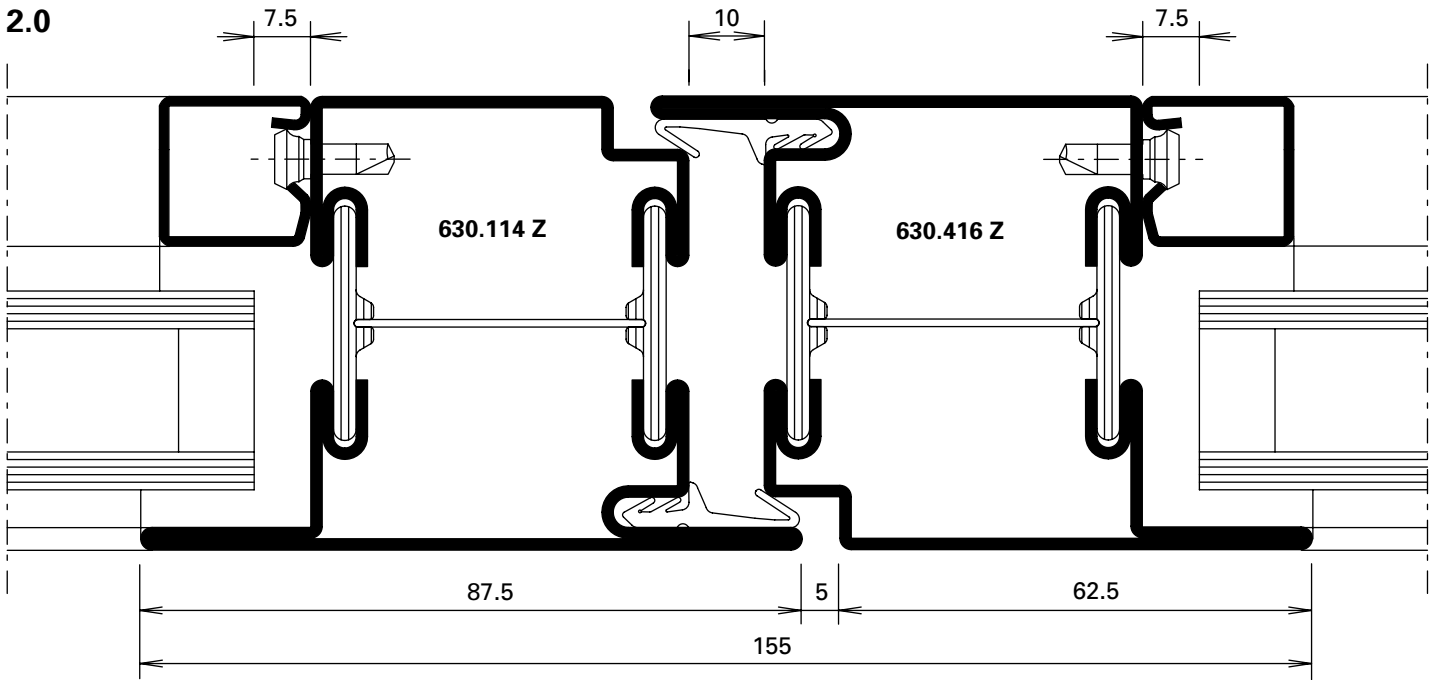

DXF DWG D-100-C-009

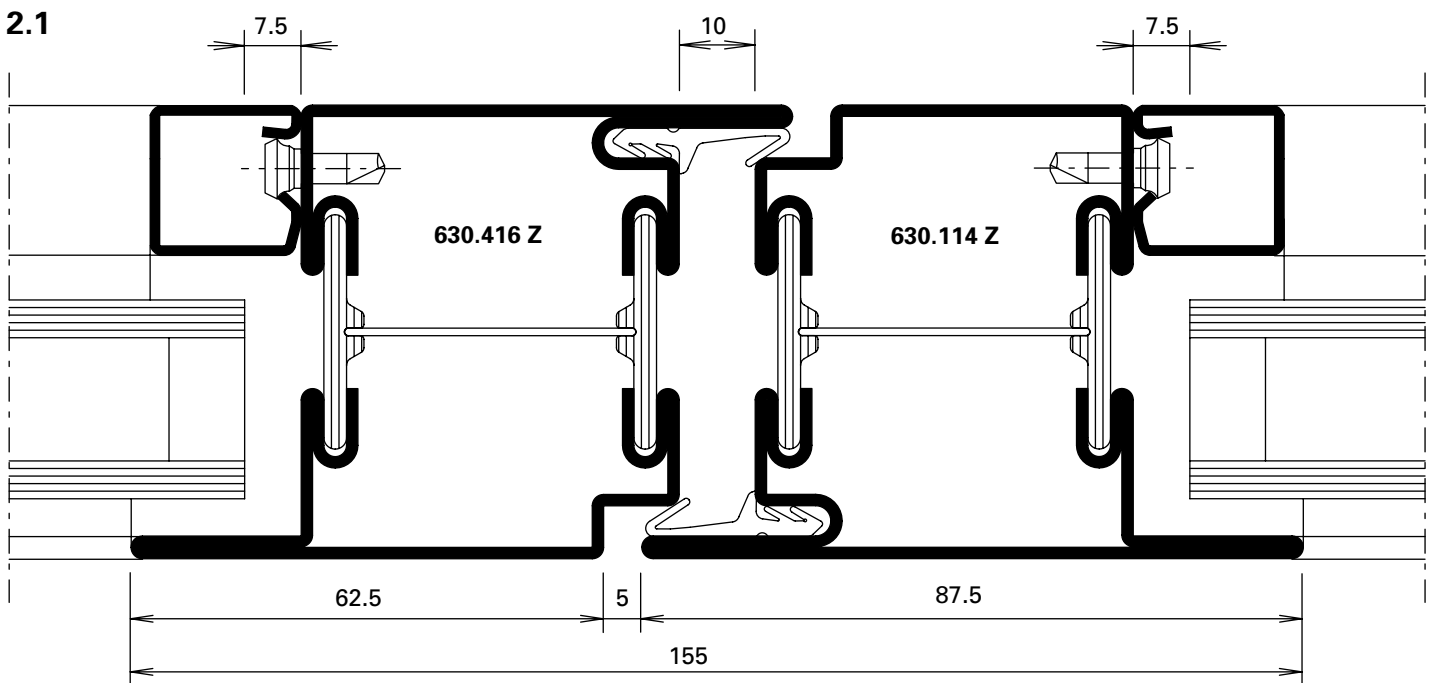

DXF DWG D-100-C-010

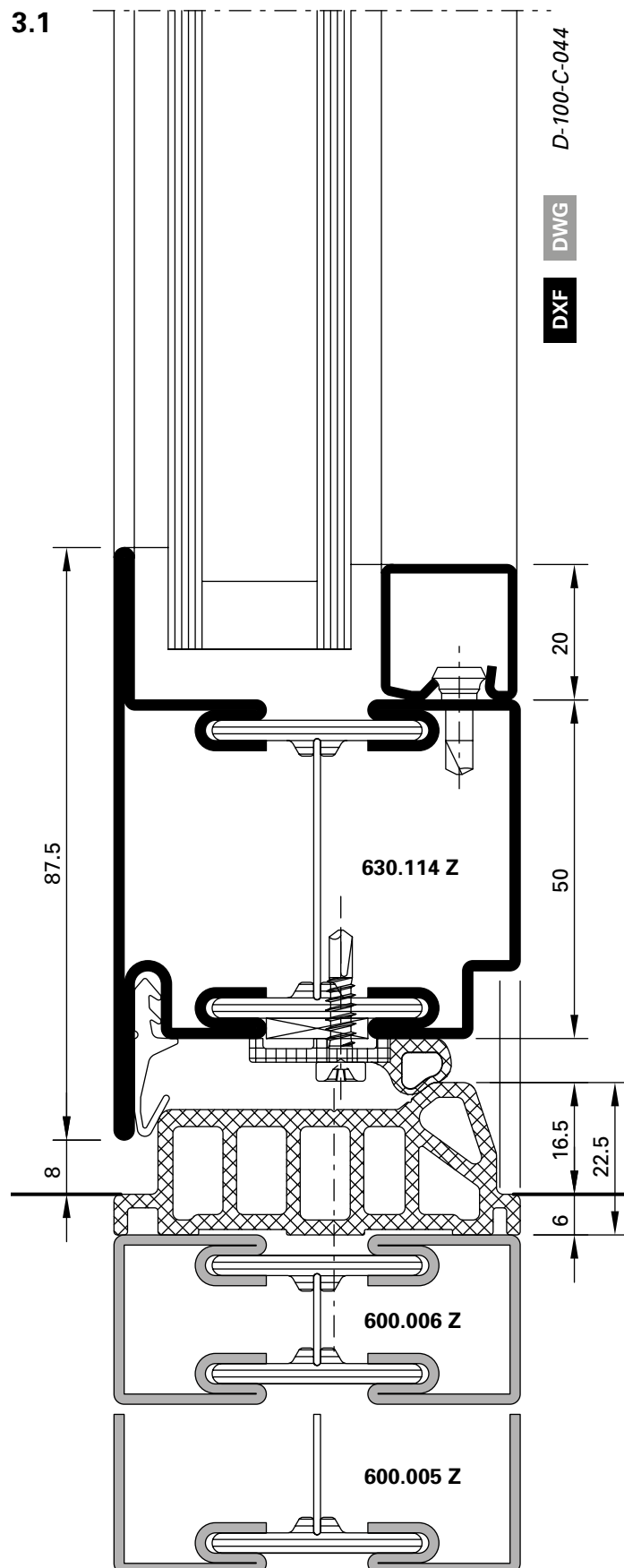
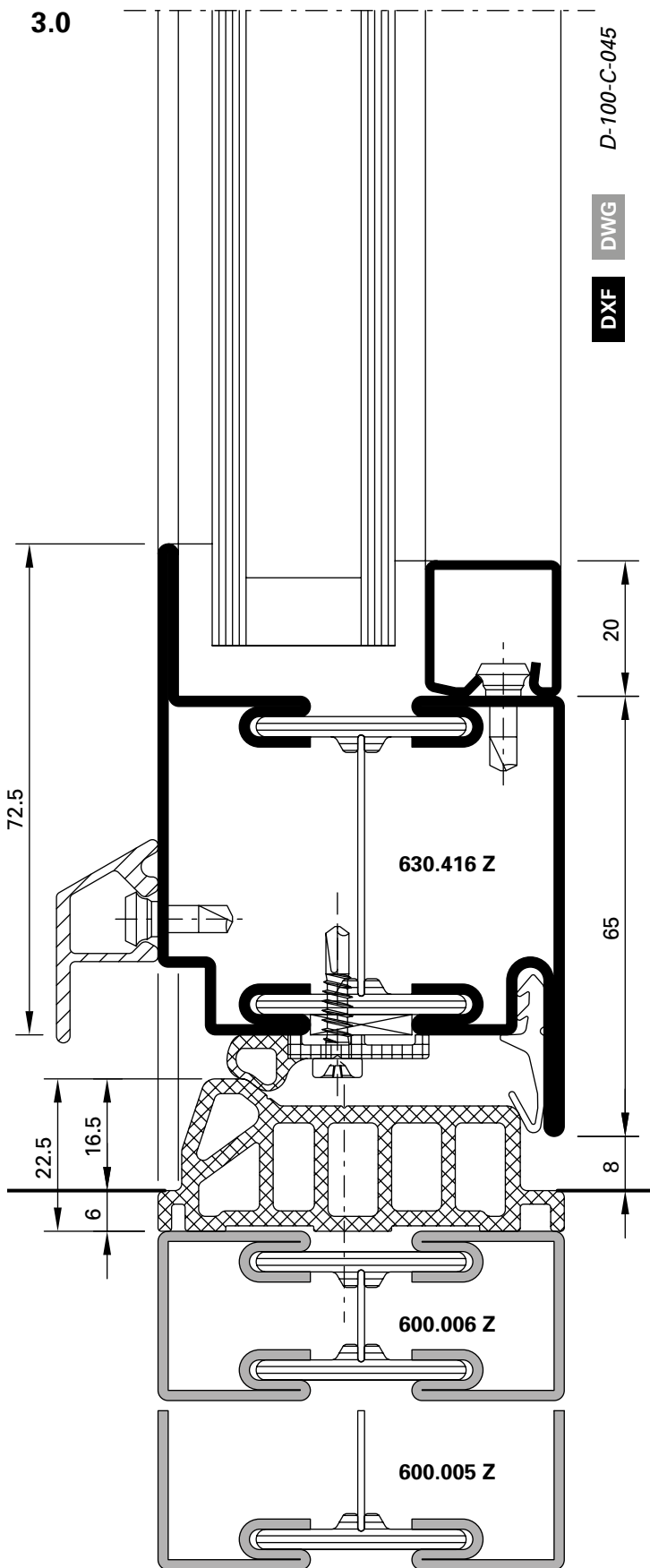

3.2

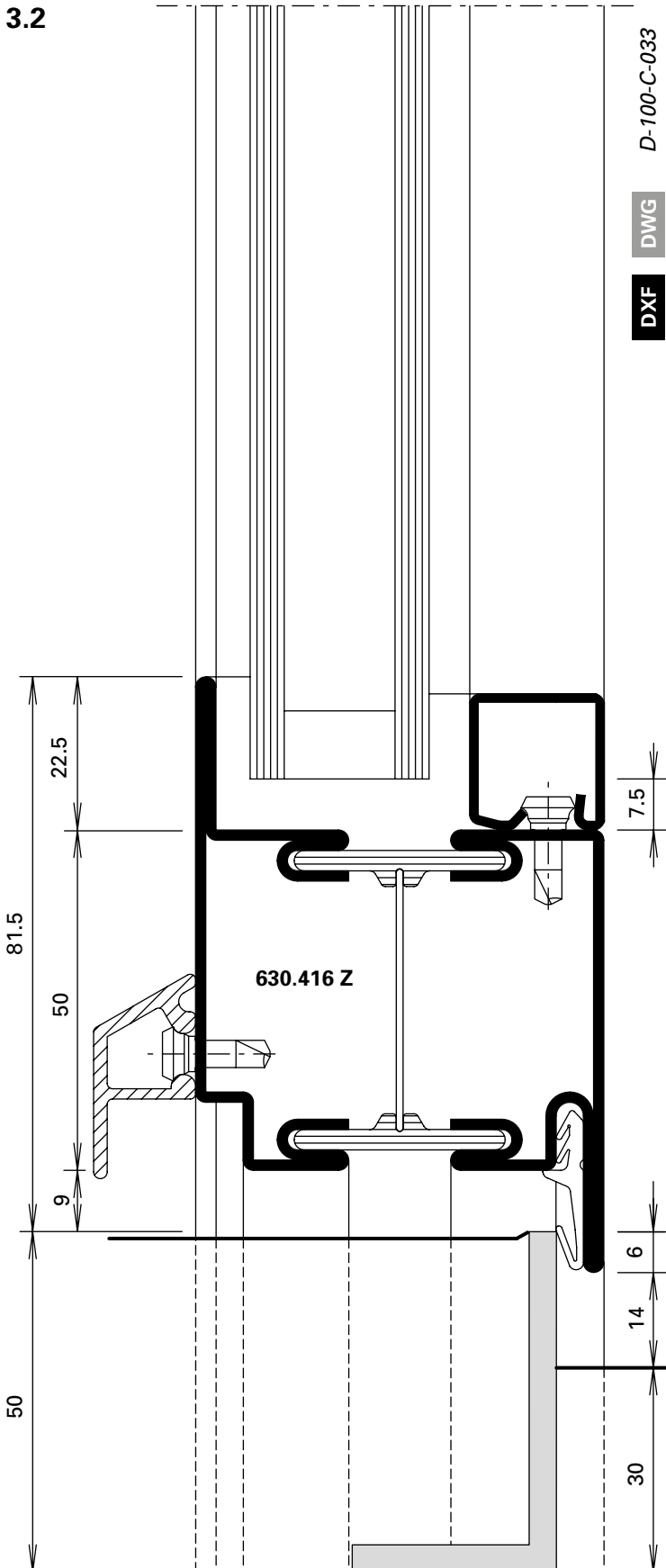

3.4

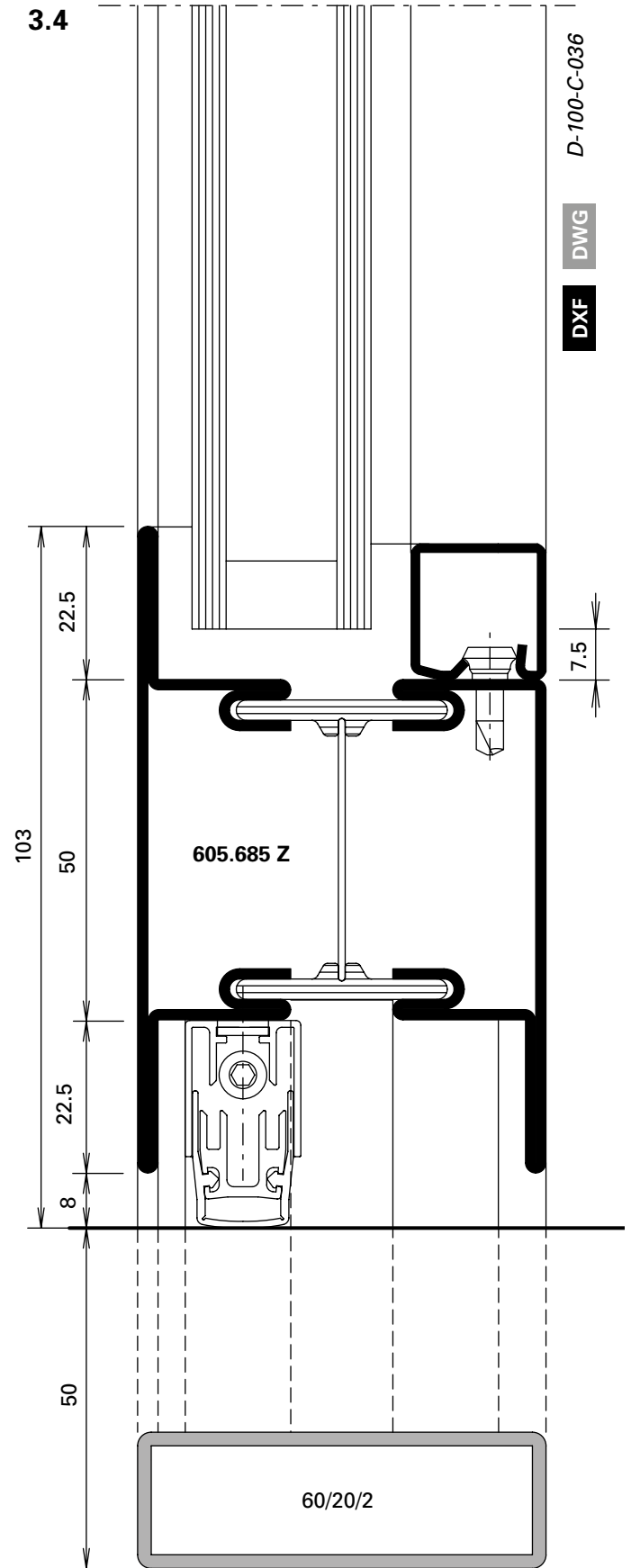

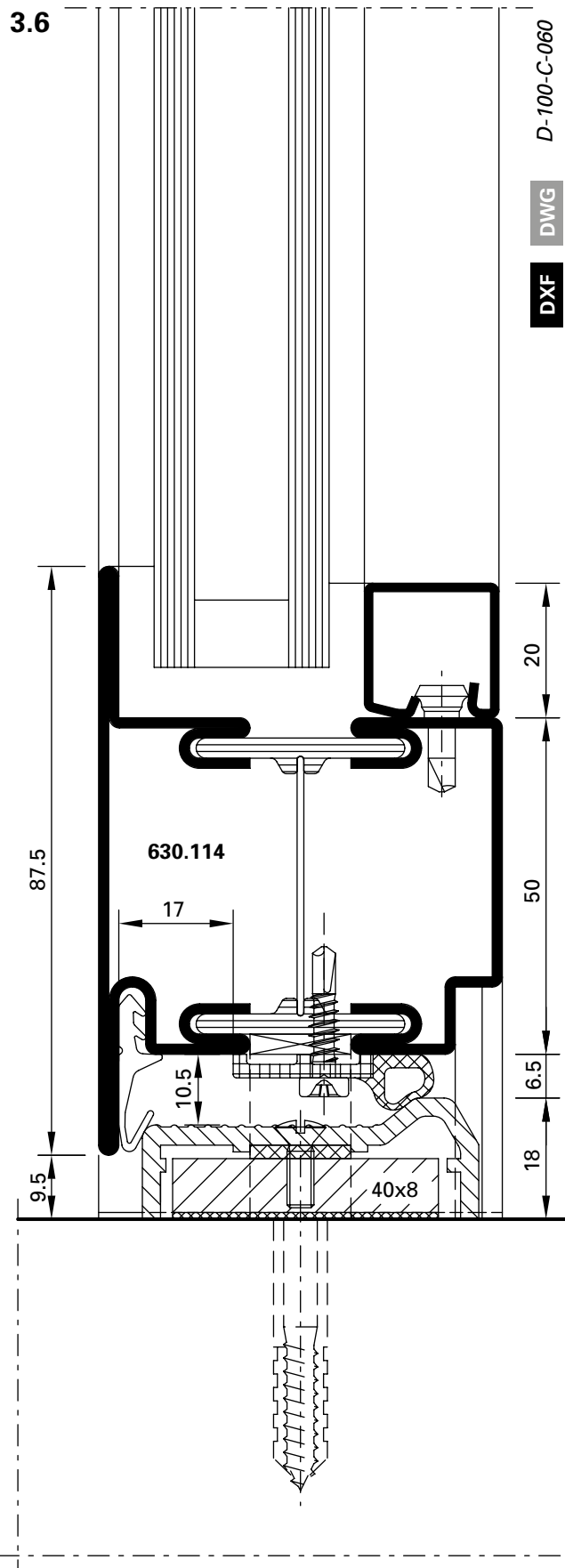
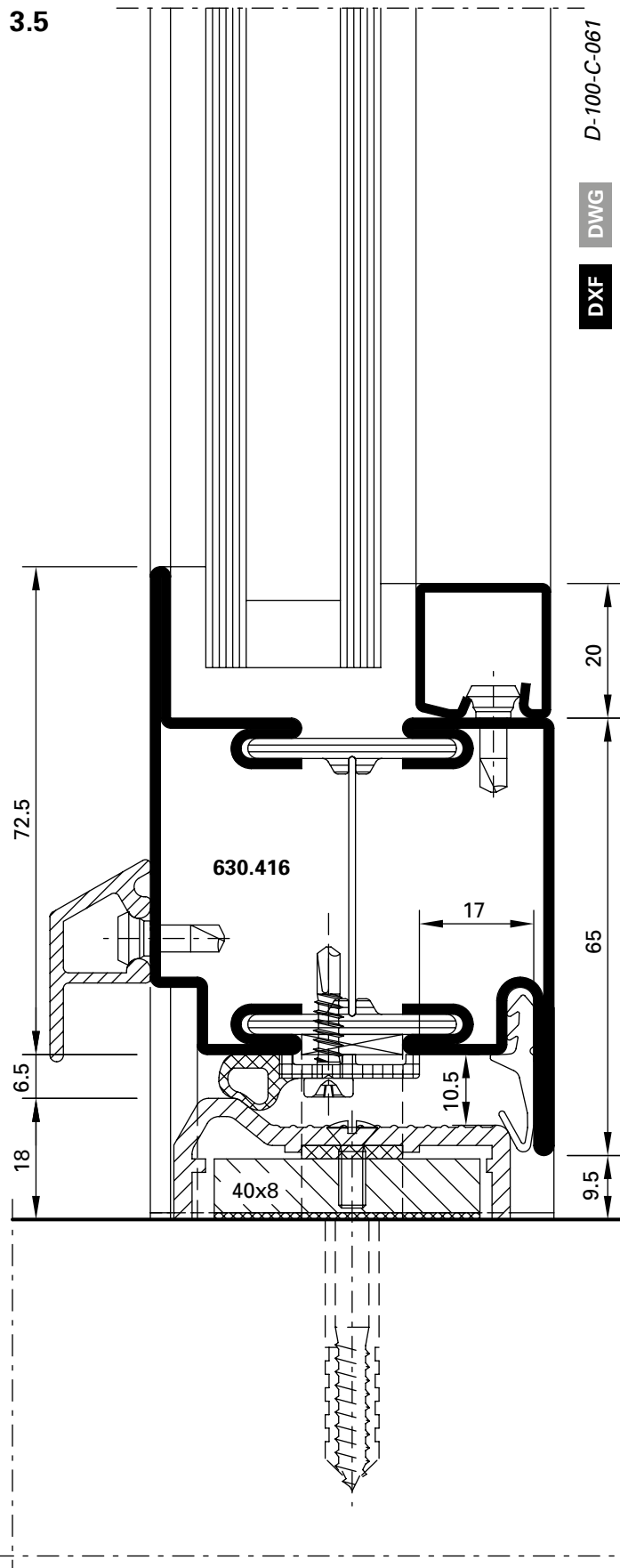

1.5

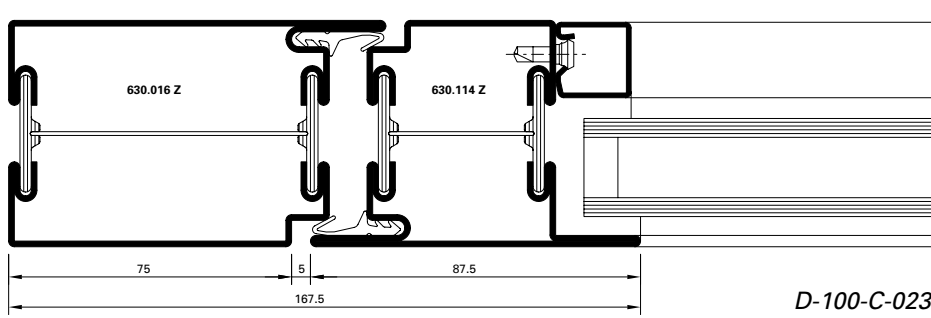

D-100-C-023

DXF DWG

1.6

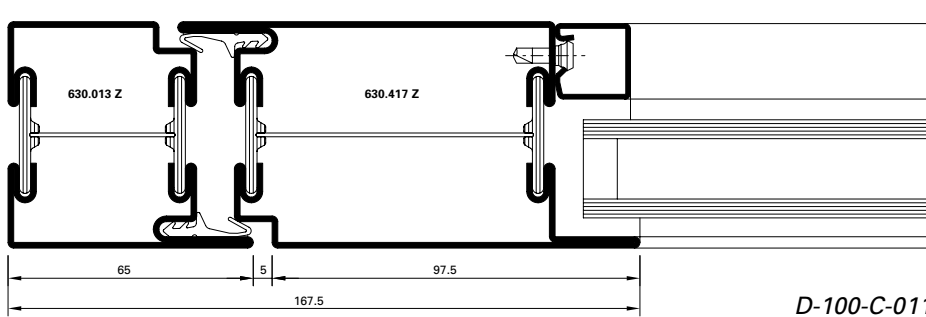

D-100-C-011

DXF DWG

1.7

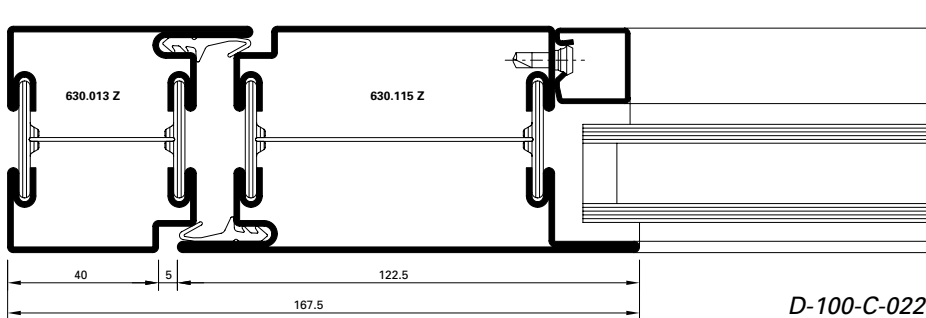

D-100-C-022

DXF DWG

2.2

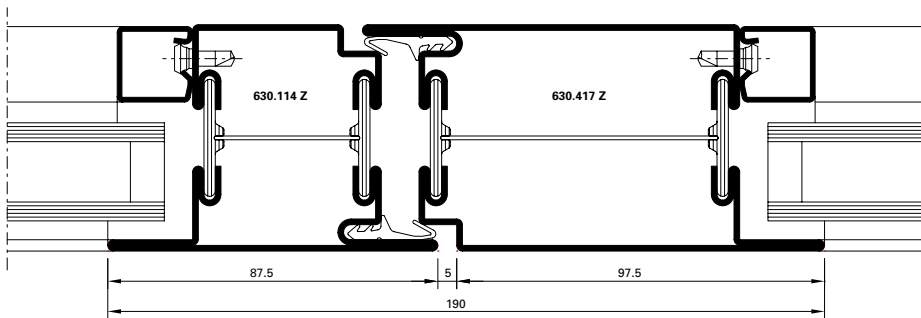

DXF **DWG** *D-100-C-024*

2.3

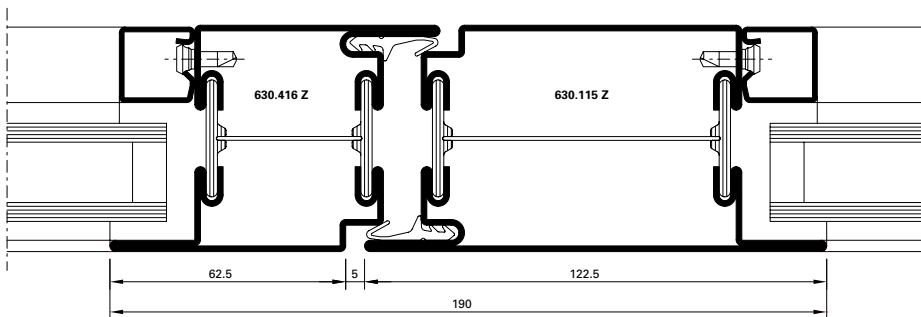

DXF **DWG** *D-100-C-025*

2.4

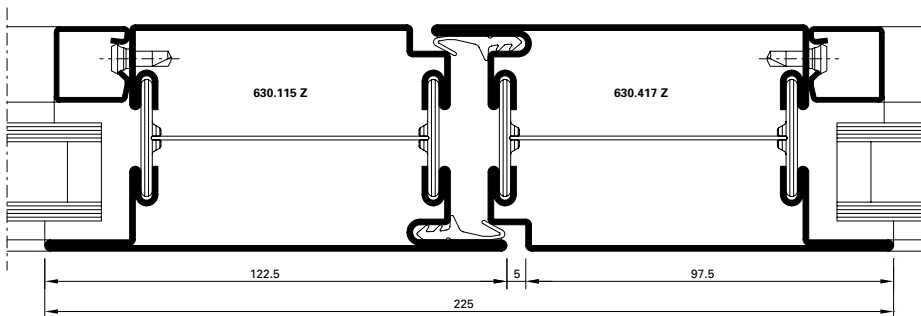

DXF **DWG** *D-100-C-026*

2.5

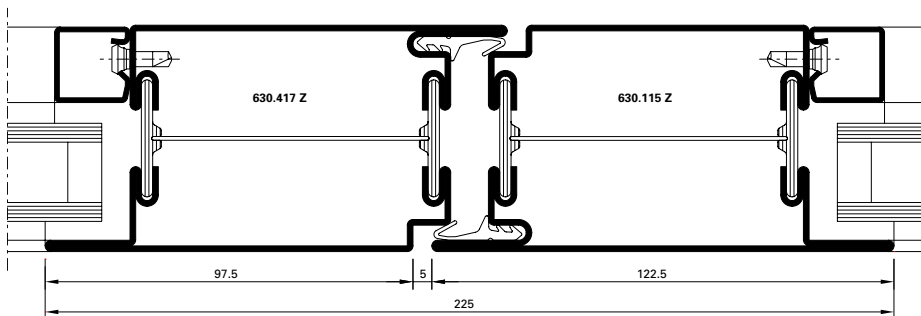

DXF **DWG** *D-100-C-027*

2.6

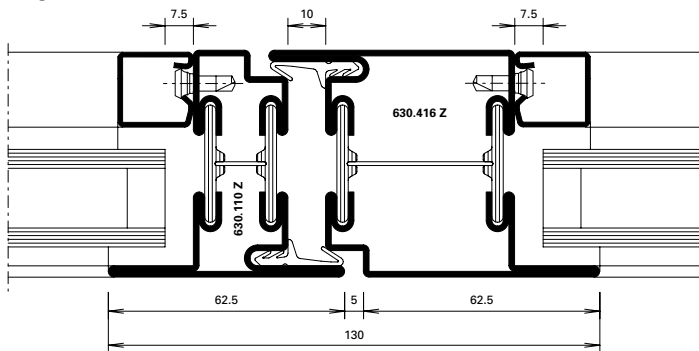

DXF DWG D-100-C-014

2.7

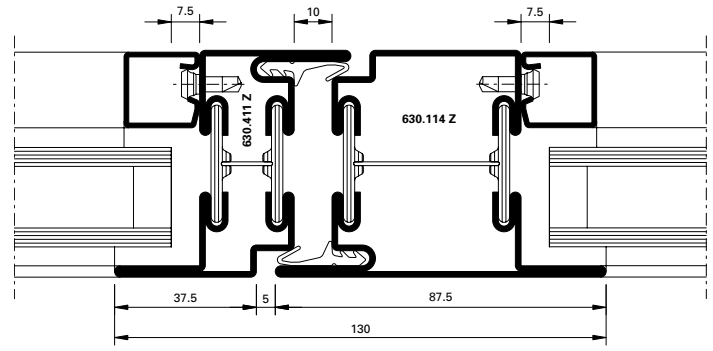

DXF DWG D-100-C-013

10.1

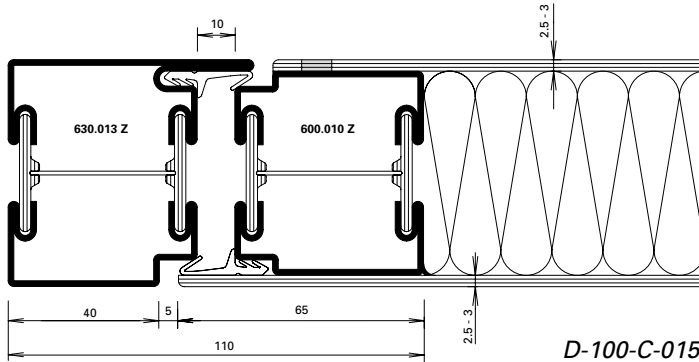

D-100-C-015

DXF DWG

10.2

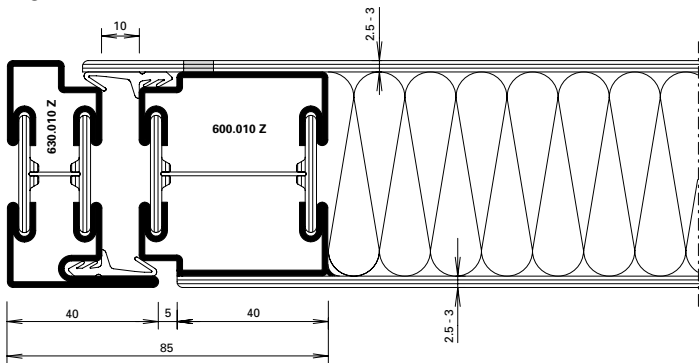

DXF DWG D-100-C-018

10.3

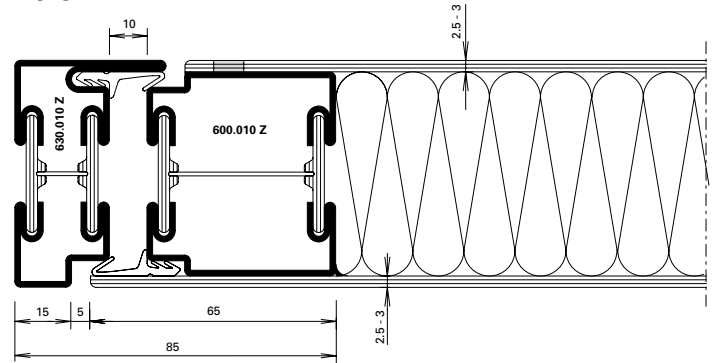

DXF DWG D-100-C-019

Aufgrund möglicher Deformationen von verblechten Türen in exponierten Lagen mit Sonneneinstrahlung sollte diese Anwendung nicht eingesetzt werden, ansonsten ist eine Beschattung vorzusehen.

Au vu de déformations possibles, ne pas exposer les portes tôles au rayonnement direct du soleil (effet bimétal). Si possible prévoir une protection solaire.

Due to potential deformations of sheet metal clad doors in exposed locations with sunlight this application should not be used otherwise a shading must be provided.

Hinweis Oberflächenbehandlung:
 Wegen der Lochschweißungen empfehlen wir eine Nasslackierung mit vorgängigem Spachteln.

Indications sur le traitement de surface:
 En raison des soudures bouchons, nous recommandons un laquage avec vernis liquide précédé d'un rebouchage.

Surface treatment note:
 We recommend wet lacquering preceded by priming, due to the plug welds.

11.0

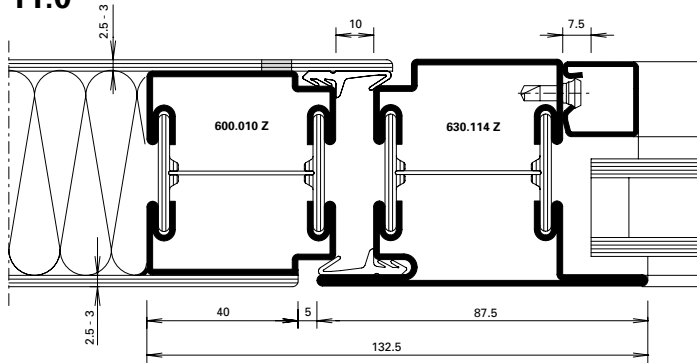

DXF **DWG** D-100-C-016

11.1

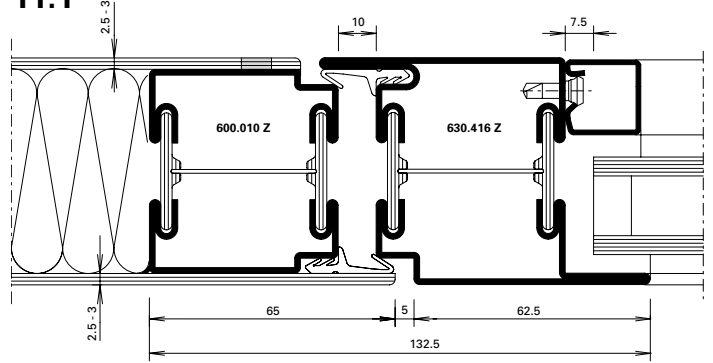

DXF **DWG** D-100-C-017

11.2

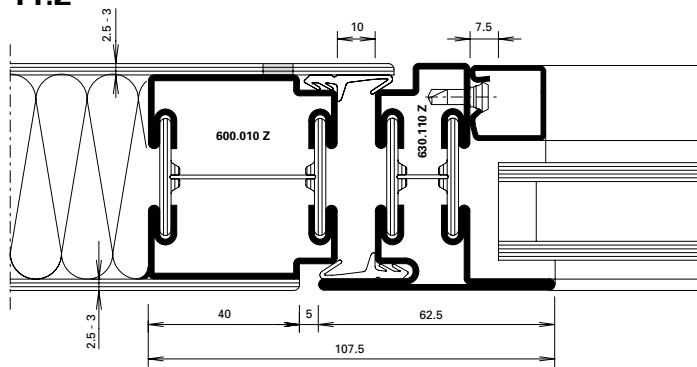

DXF **DWG** D-100-C-020

11.3

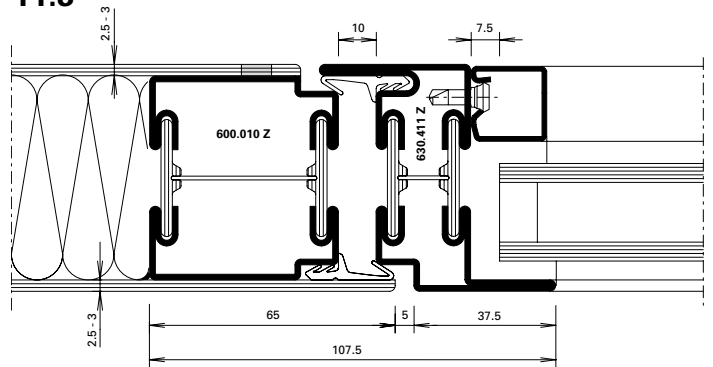

DXF **DWG** D-100-C-021

12.0

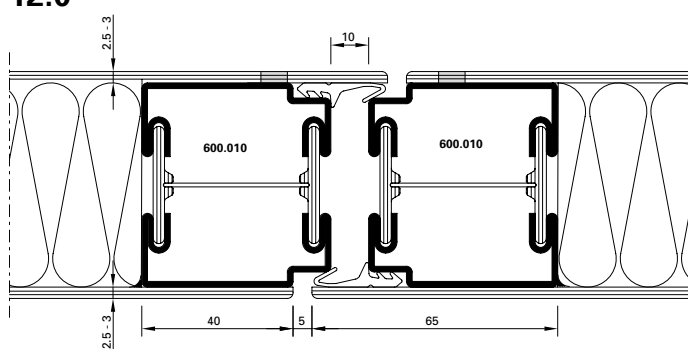

DXF **DWG** D-100-C-065

12.1

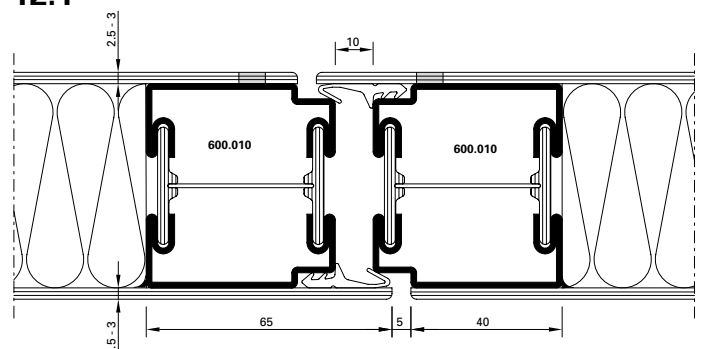

DXF **DWG** D-100-C-066

4.0

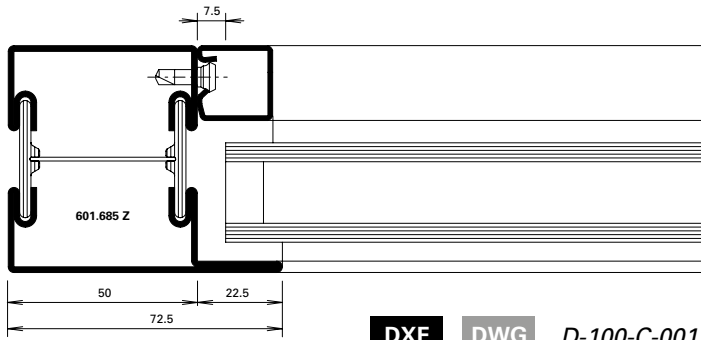

DXF **DWG** D-100-C-001

5.0

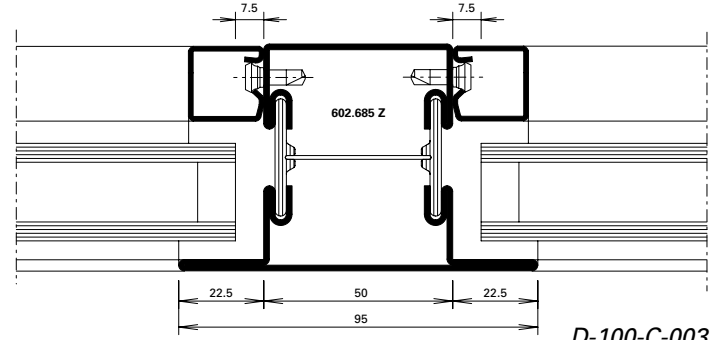

DXF **DWG** D-100-C-003

4.1



DXF **DWG** D-100-C-002

5.1

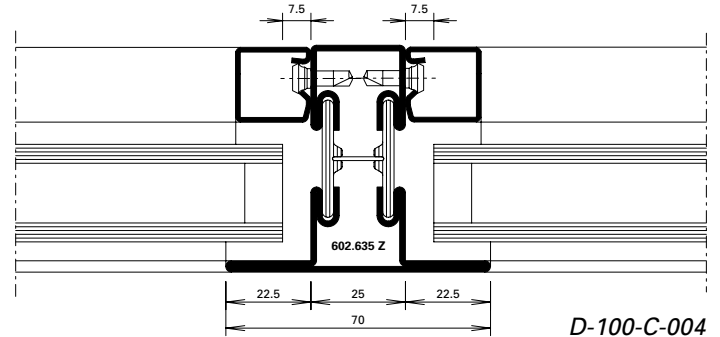

DXF **DWG** D-100-C-004

13.0

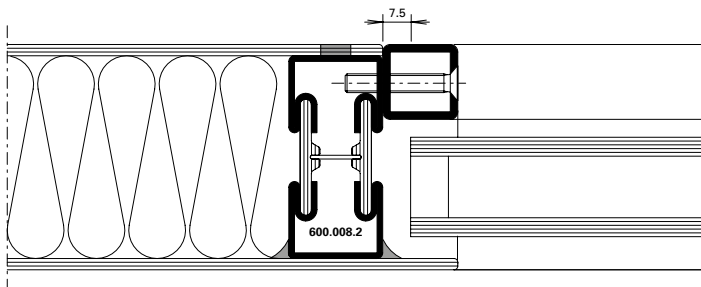

DXF **DWG** D-100-C-067

6.0

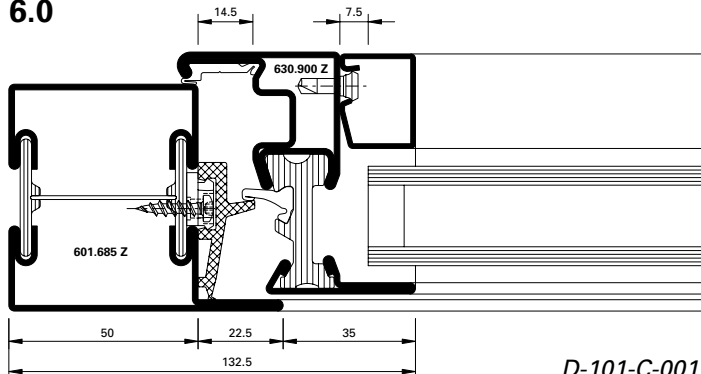

DXF **DWG** D-101-C-001

6.1

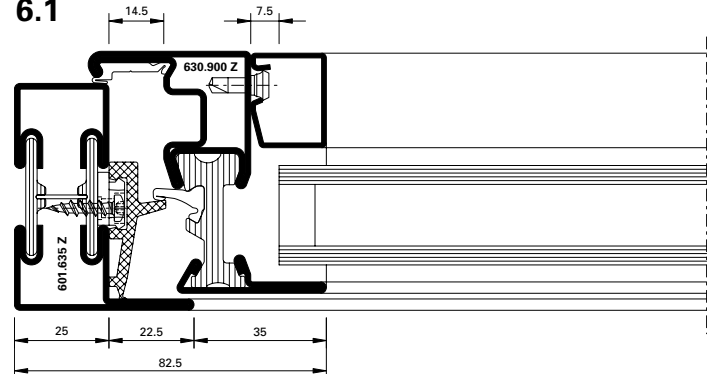

DXF **DWG** D-101-C-002

3.7

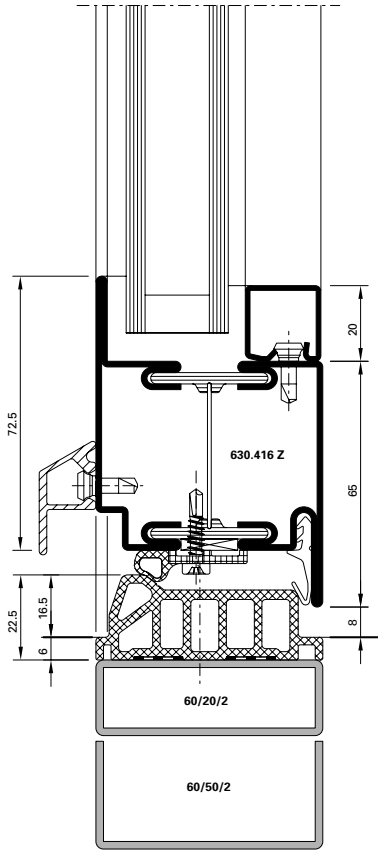

D-100-C-047

DXF DWG

3.8

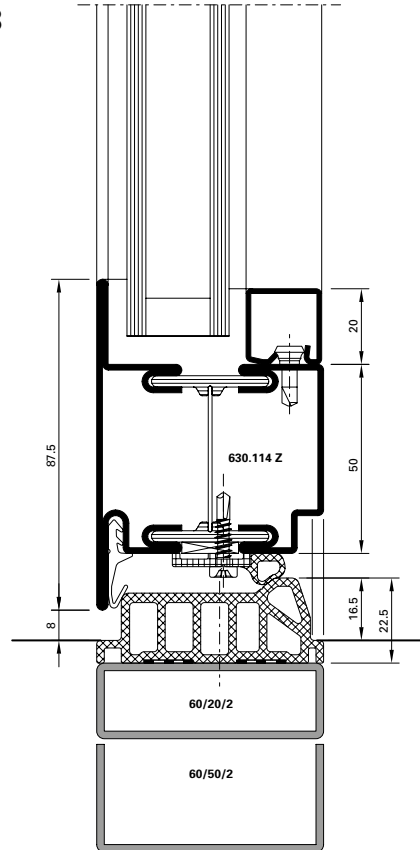

D-100-C-046

DXF DWG

3.9

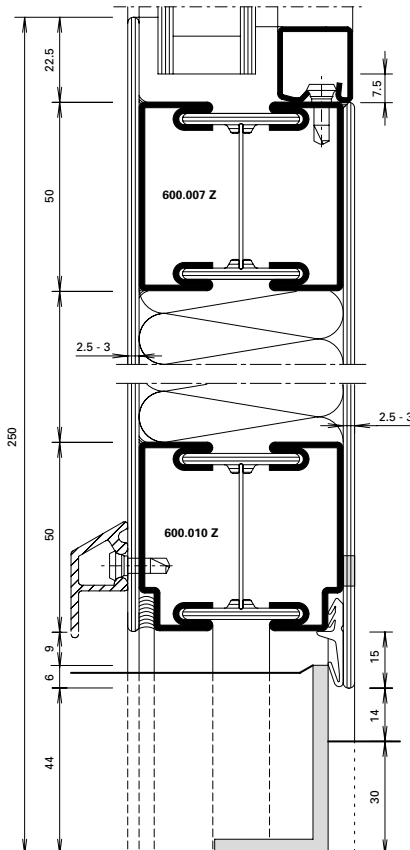

D-100-C-040

DXF DWG

3.10

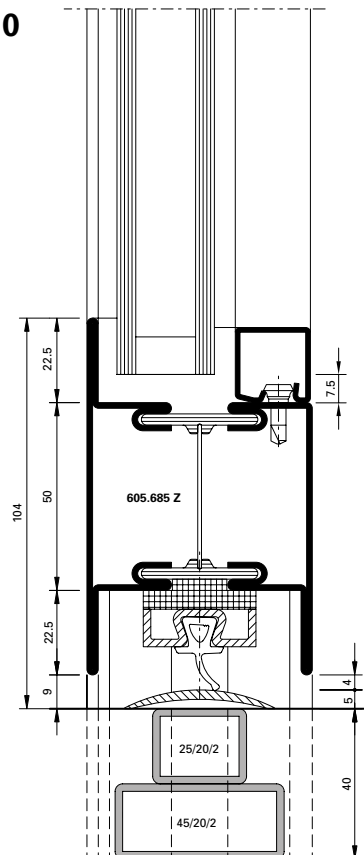

D-100-C-041

DXF DWG

3.11

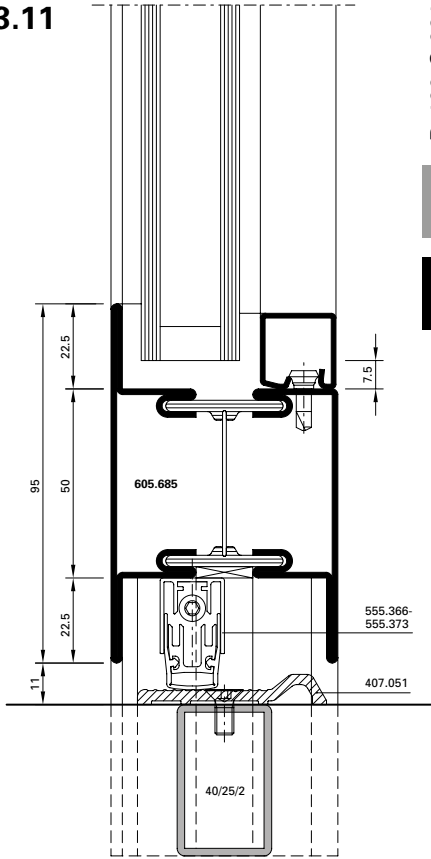

DWG D-100-C-064

DWG

DXF

3.12

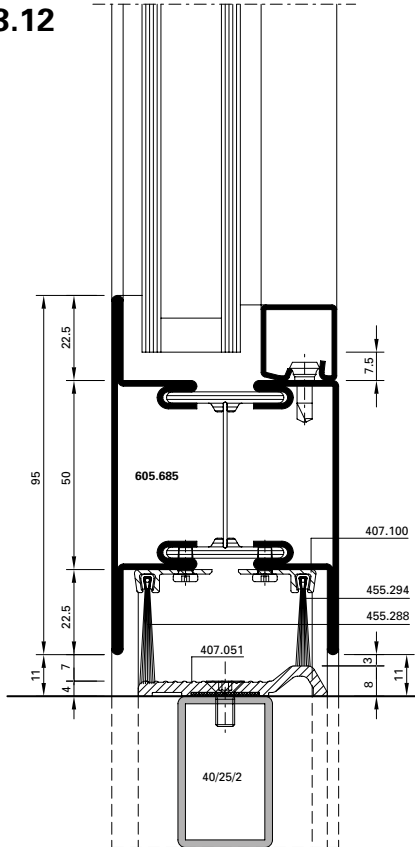

DWG D-100-C-063

DWG

DXF

3.13

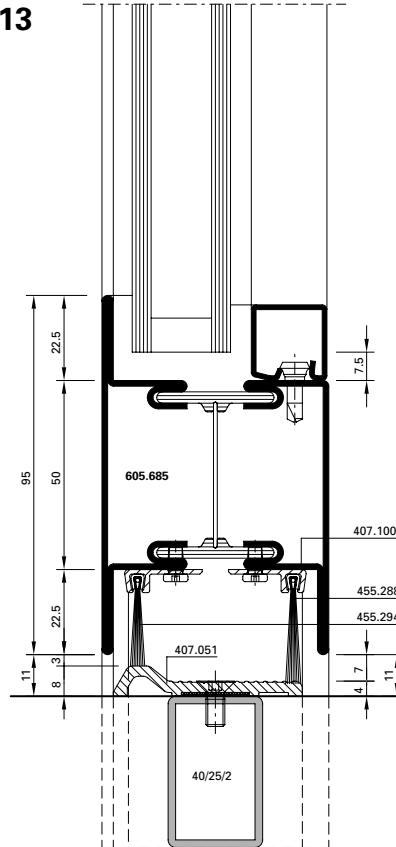

DWG D-100-C-062

DWG

DXF

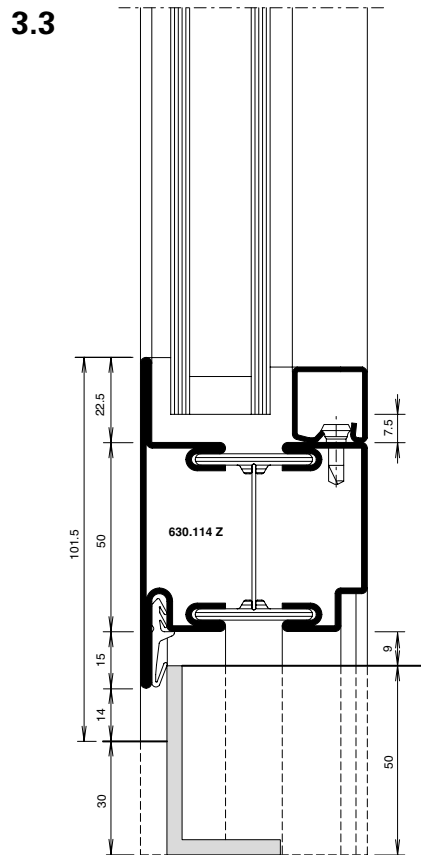

DXF **DWG** *D-100-C-035*

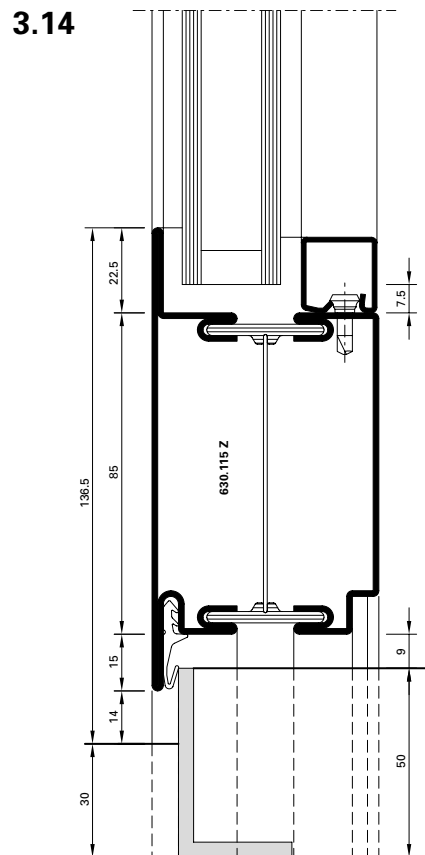

DXF **DWG** *D-100-C-039*

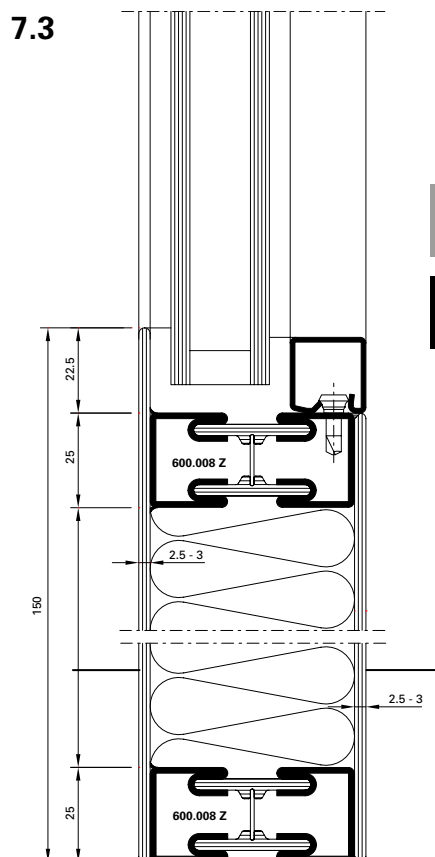

DXF **DWG** *D-100-C-048*

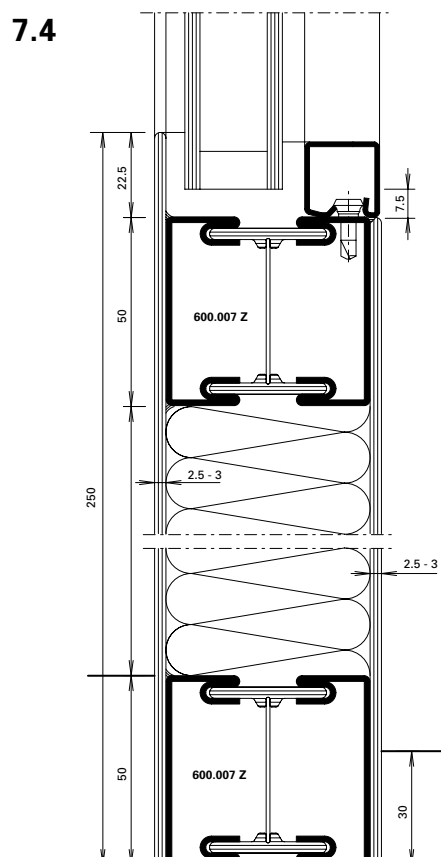

DXF **DWG** *D-100-C-037*

7.0

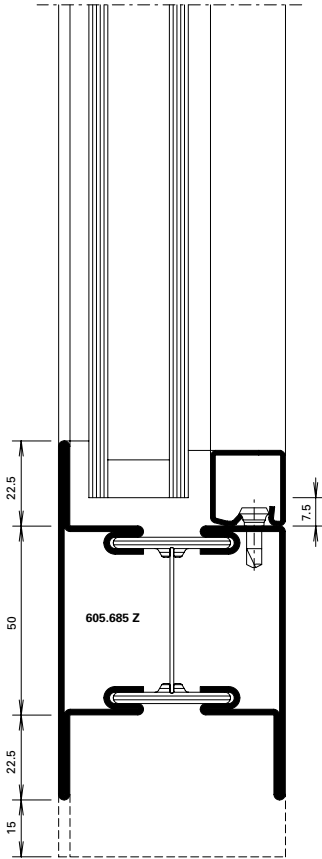

D-100-C-032

DWG

DXF

7.2

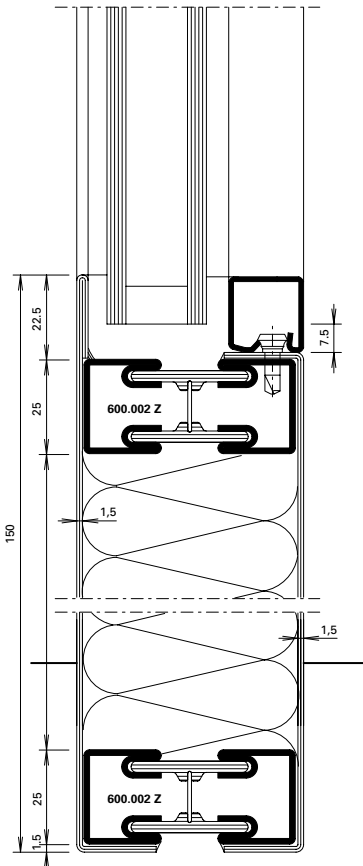

D-100-C-038

DWG

DXF

8.0

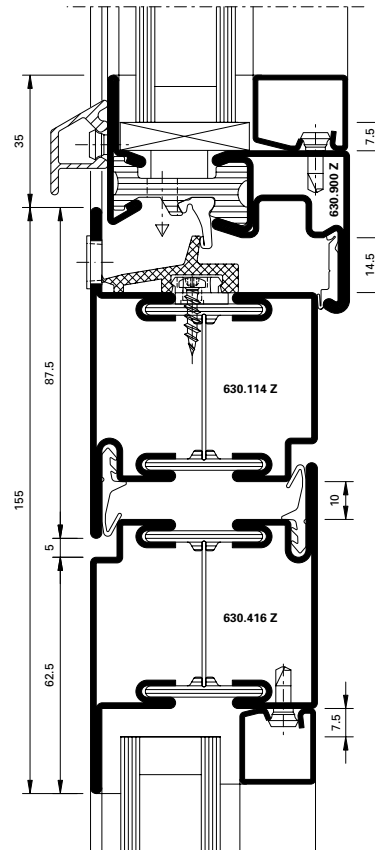

D-100-C-030

DWG

DXF

8.1

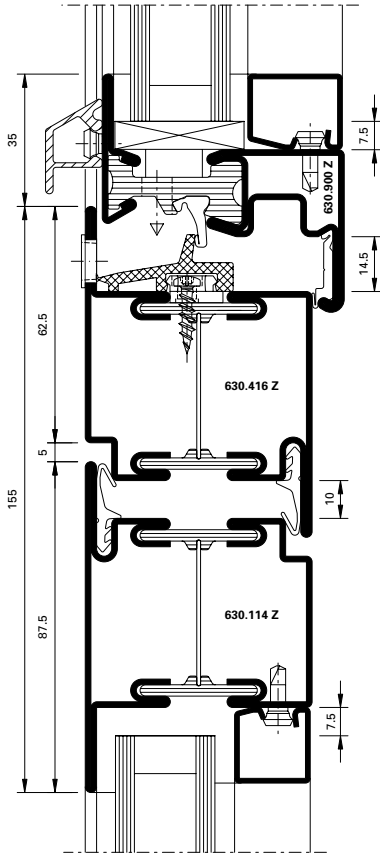

DXF **DWG** *D-100-C-031*

9.0

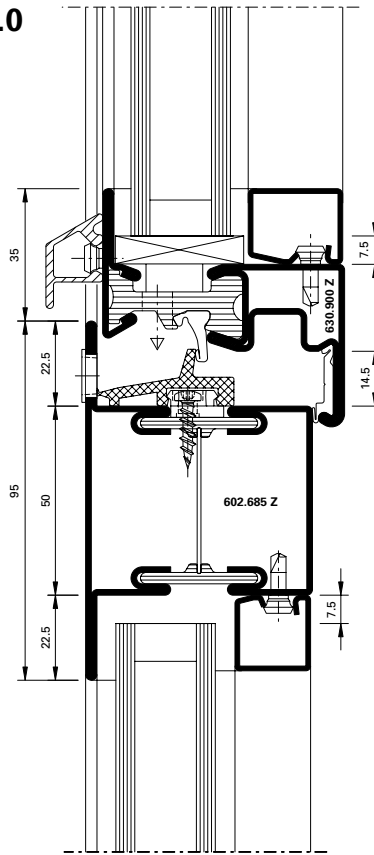

DXF **DWG** *D-101-C-014*

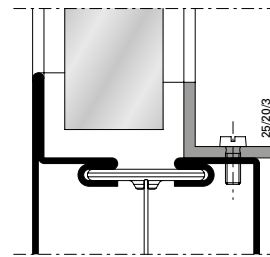
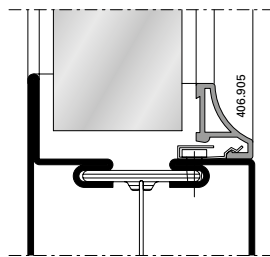
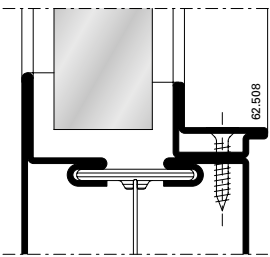
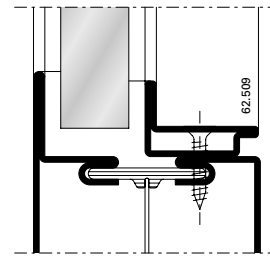
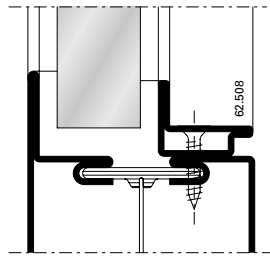
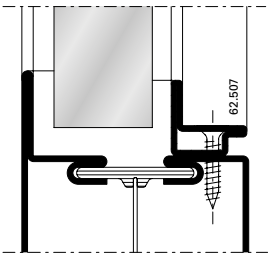
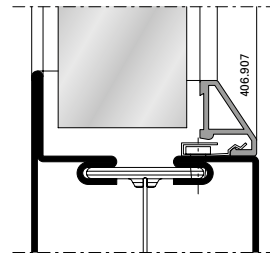
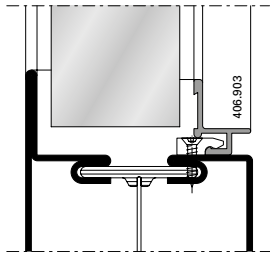
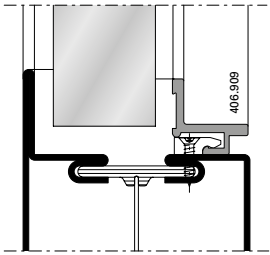
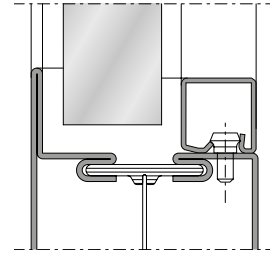
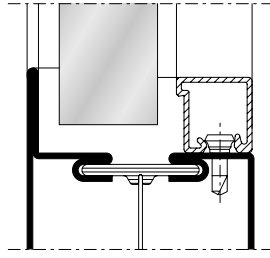
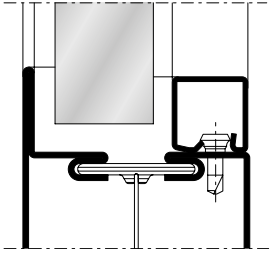

**Für Einsatz in geschützten Bereichen
 (trocken)**

Pour utilisation en zone intérieure

For use indoors (dry)

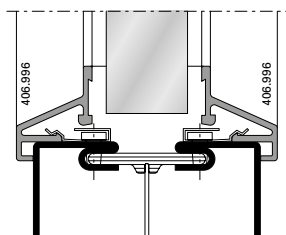
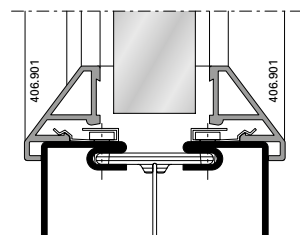

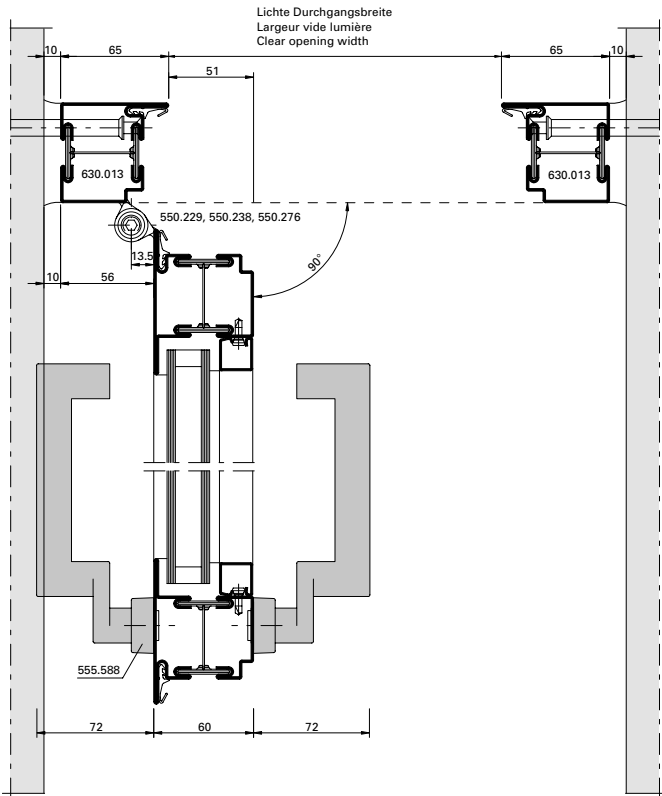

DXF DWG *D-100-E-001*

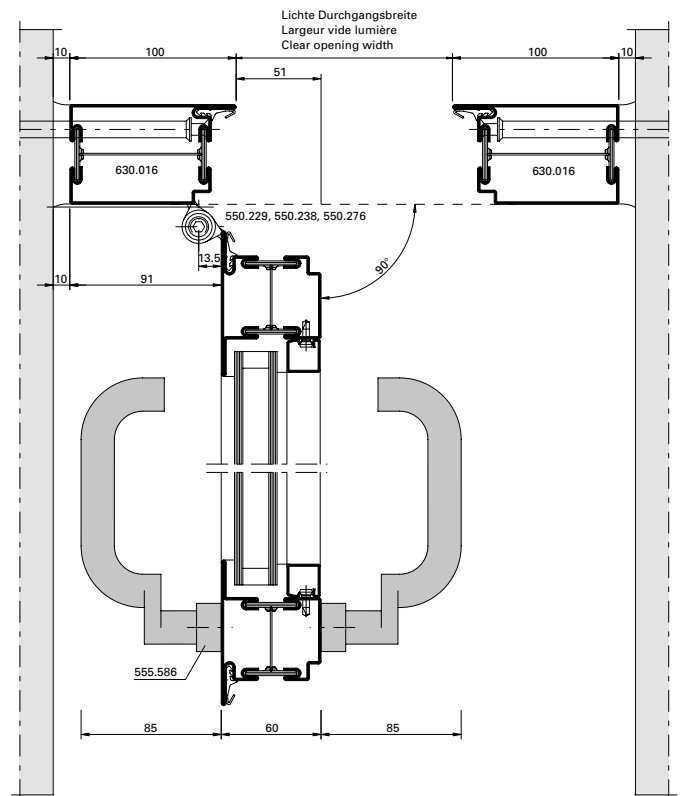

DXF DWG *D-100-E-002*

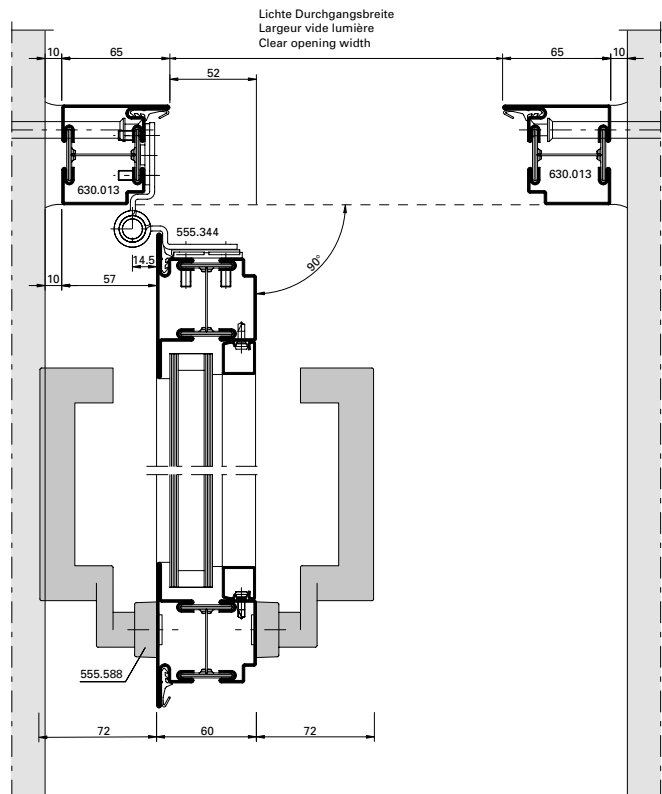

DXF DWG *D-100-E-003*

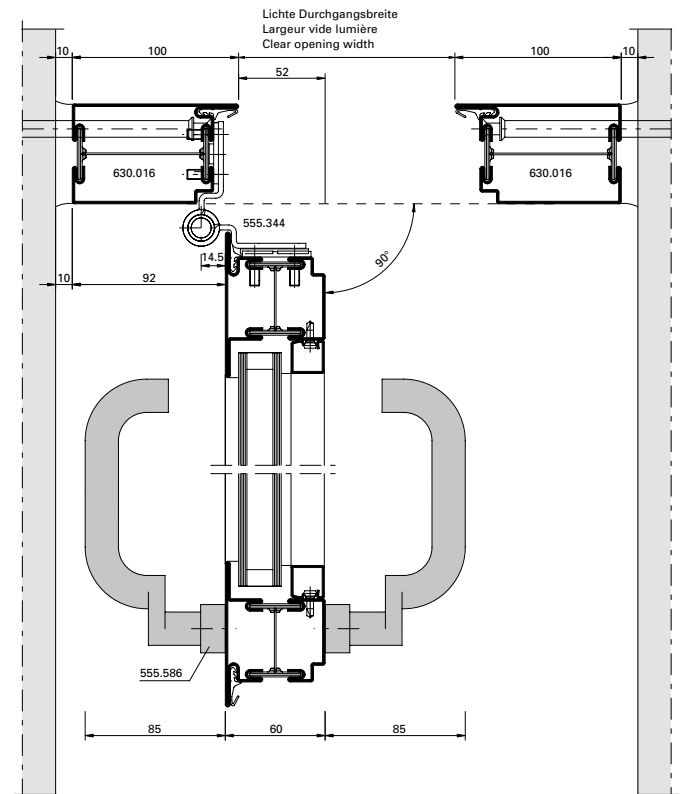

DXF DWG *D-100-E-004*

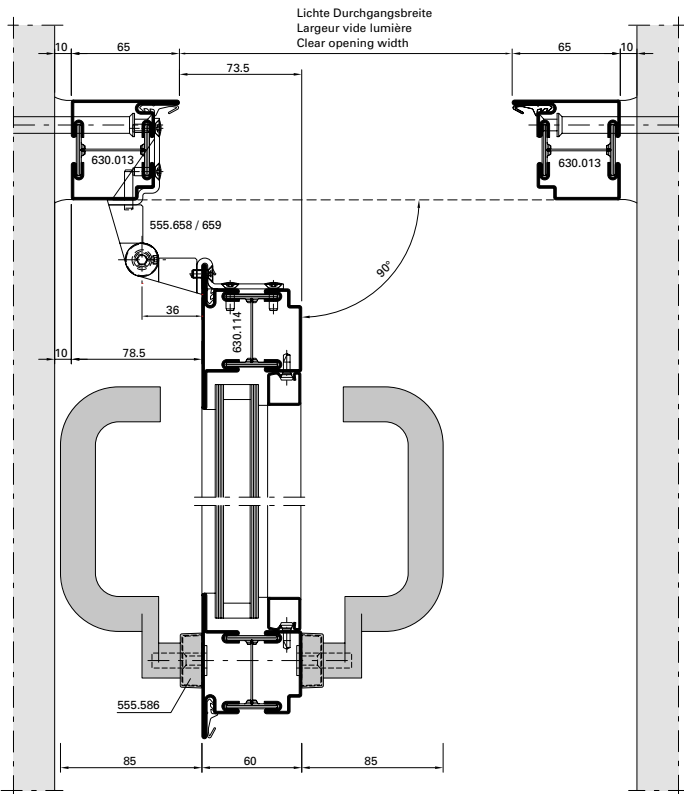

DXF **DWG** *D-100-E-028*

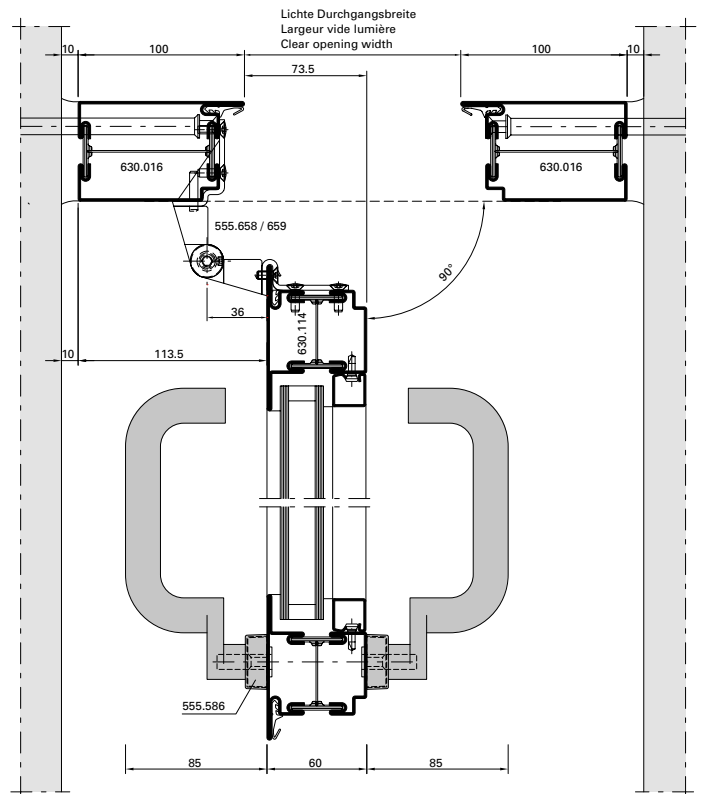

DXF **DWG** *D-100-E-027*

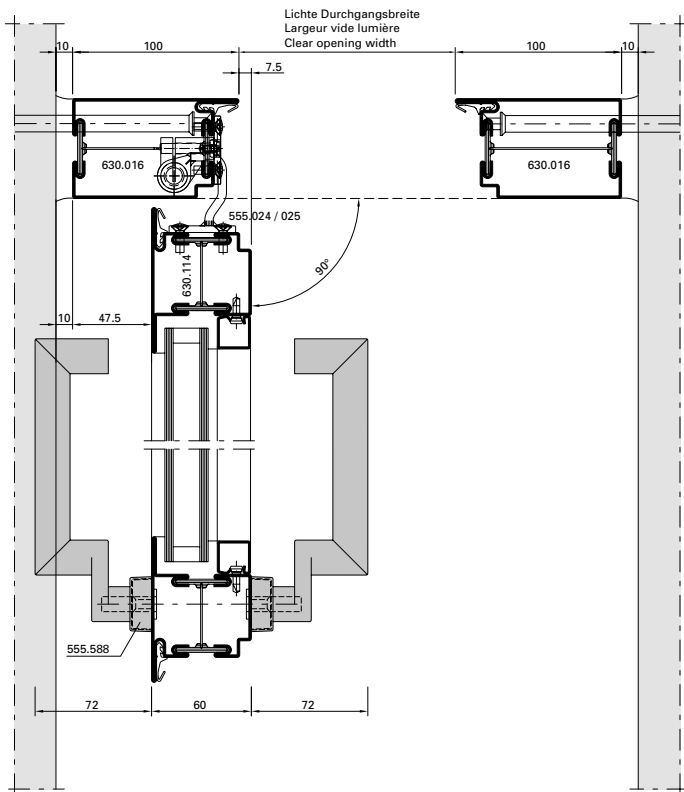

DXF **DWG** *D-100-E-029*

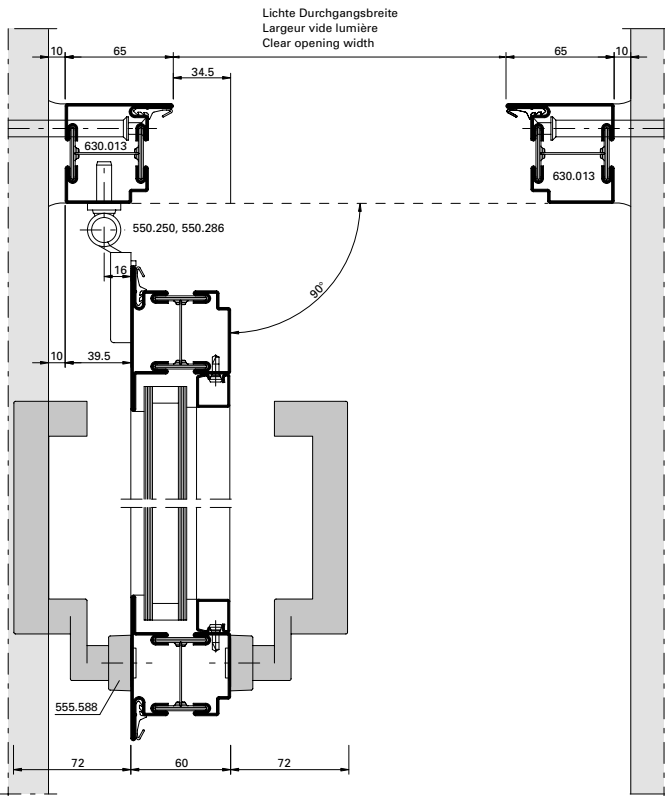

DXF DWG D-100-E-005

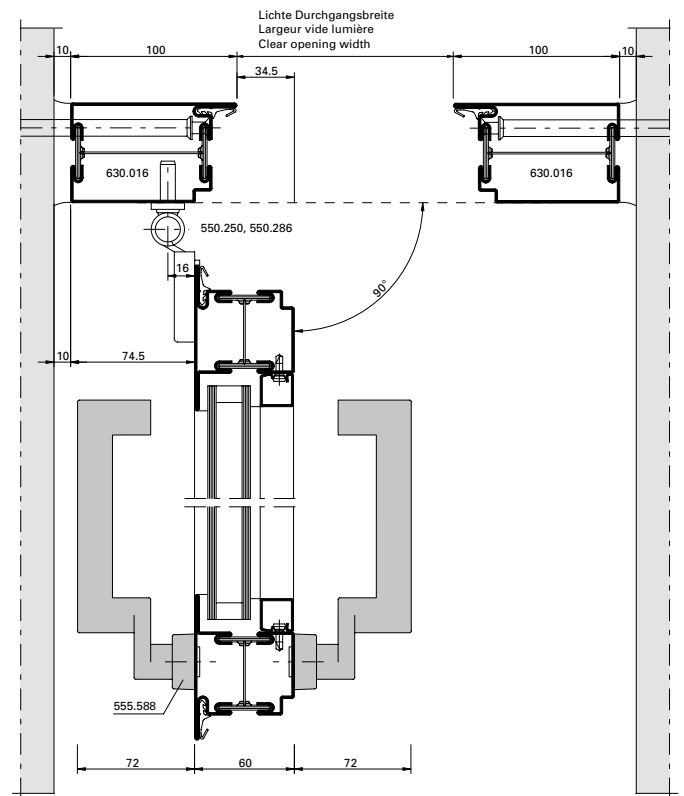

DXF DWG D-100-E-006

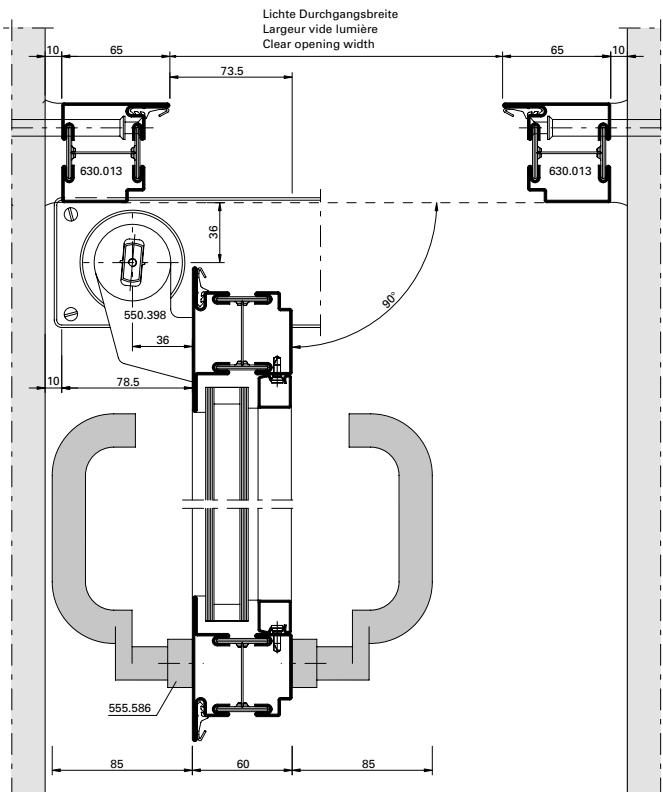

DXF DWG D-100-E-007

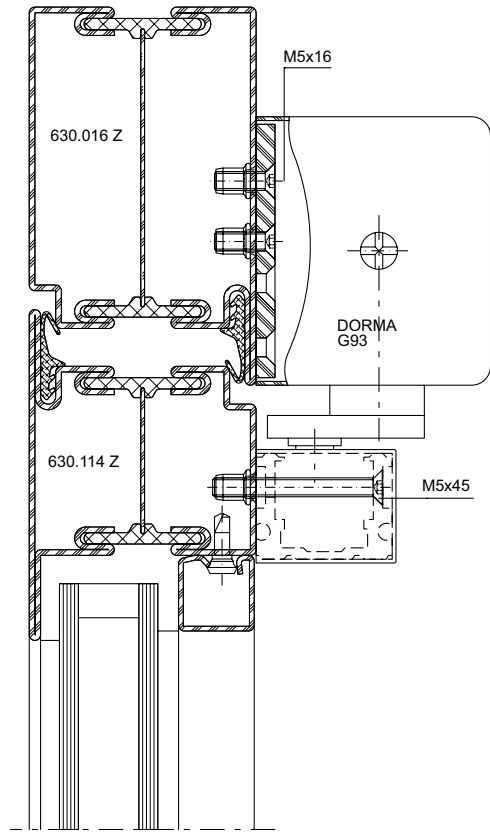
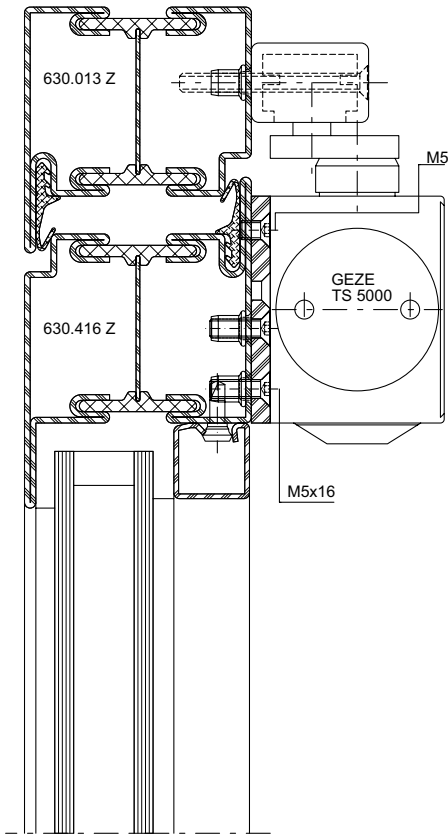

DXF

DWG

11-0101-DIV-003

DXF

DWG

11-0101-DIV-006

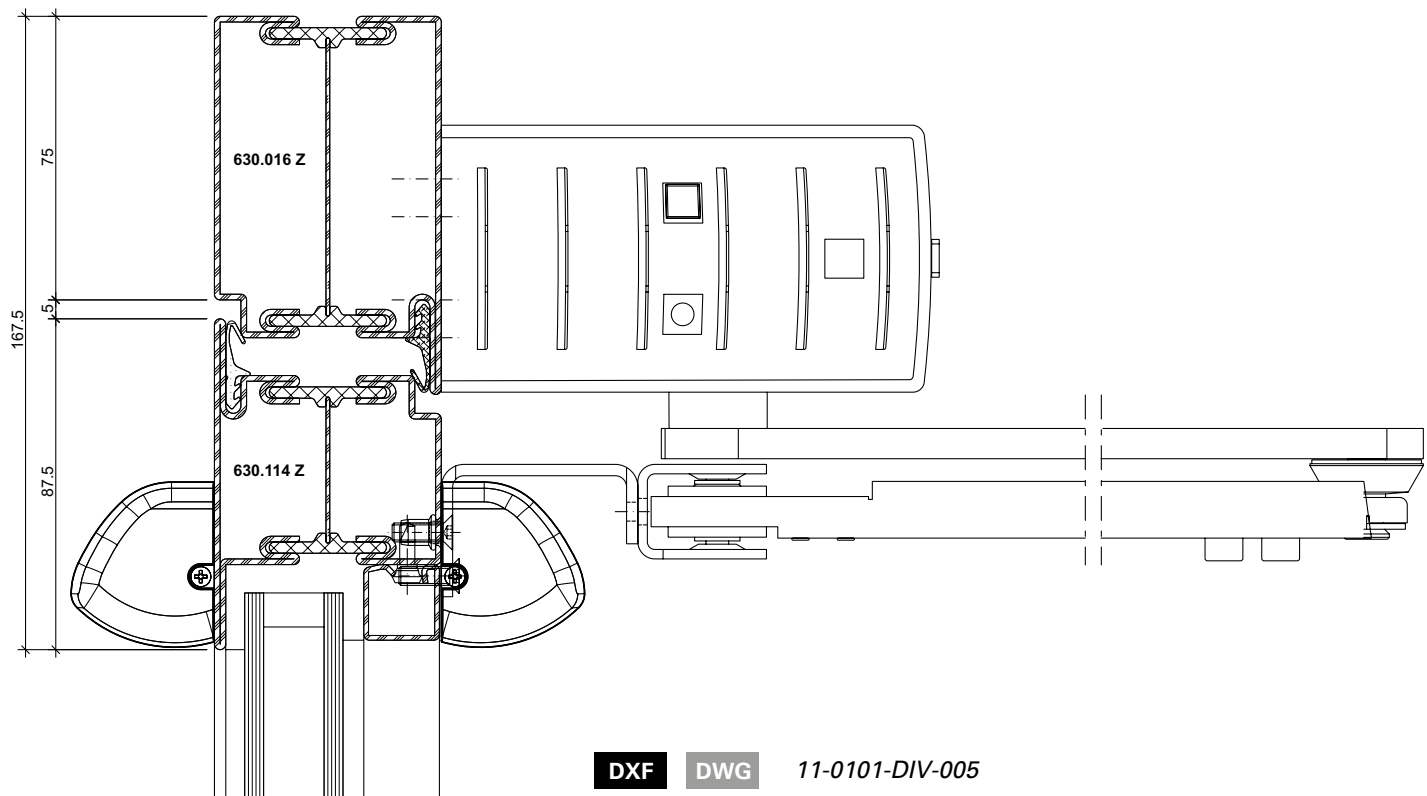
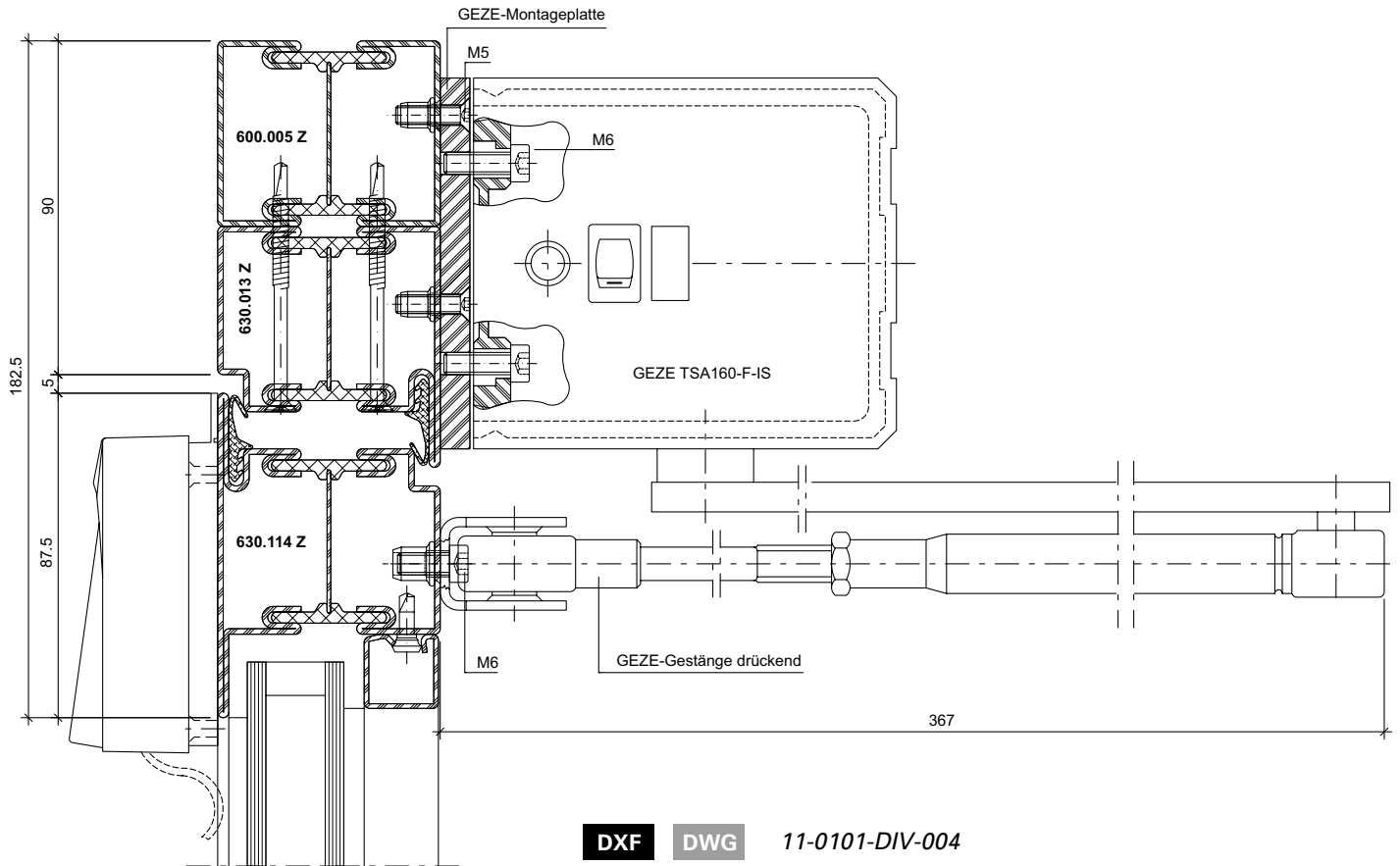

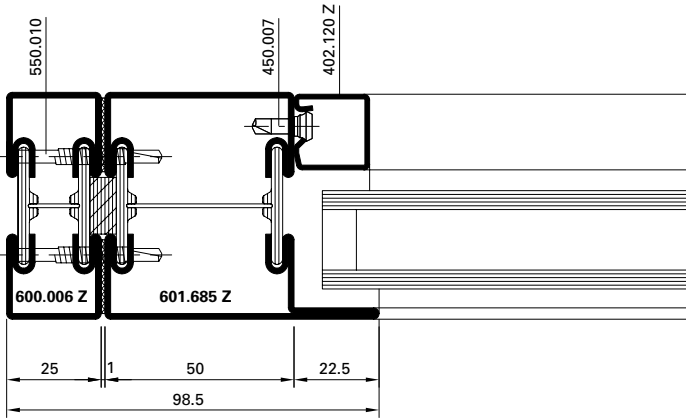

DXF **DWG** D-100-K-001

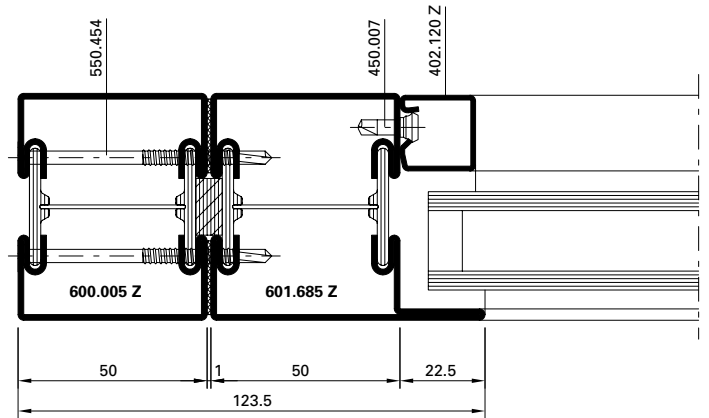

DXF **DWG** D-100-K-002

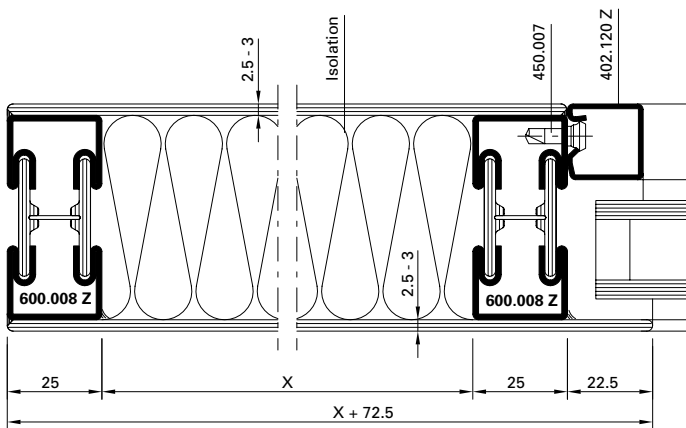

DXF **DWG** D-100-K-004

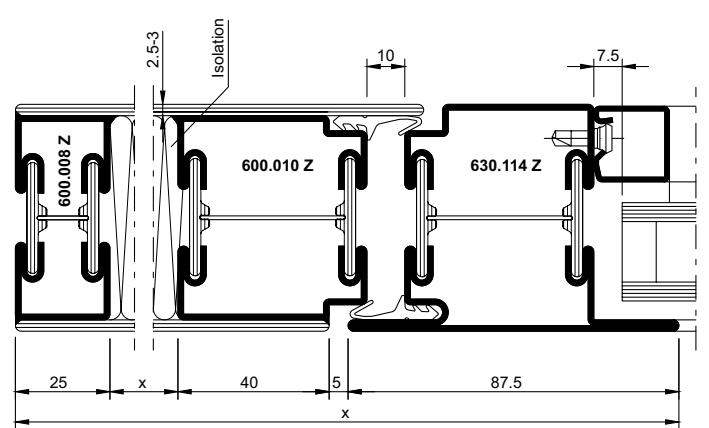

DXF **DWG** D-100-K-025

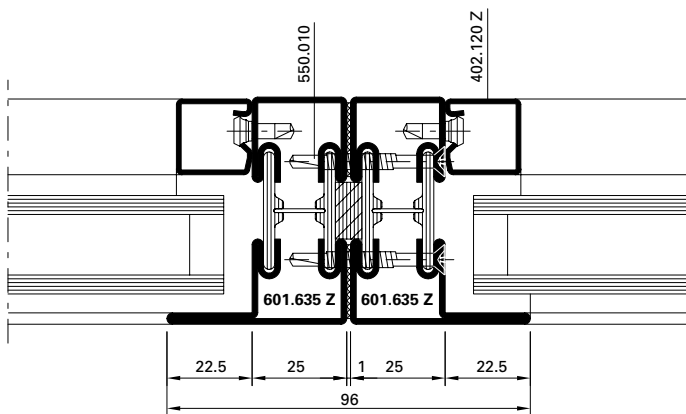

DXF **DWG** D-100-K-005

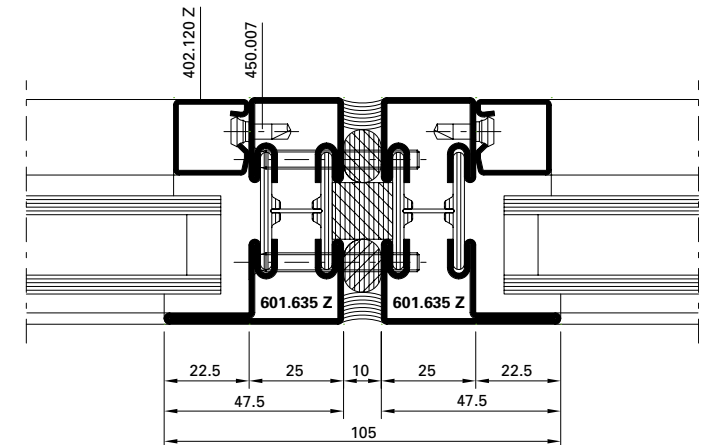

DXF **DWG** D-100-K-006

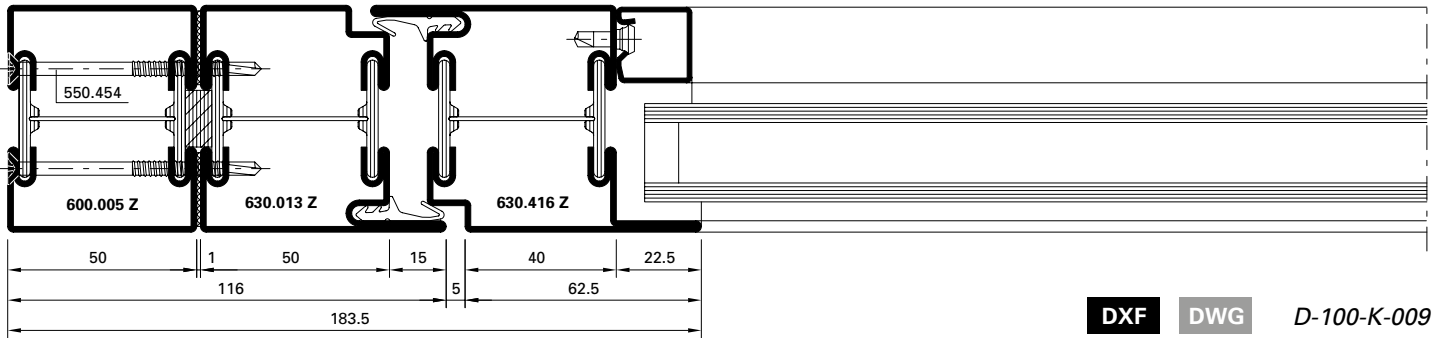

DXF **DWG** D-100-K-009

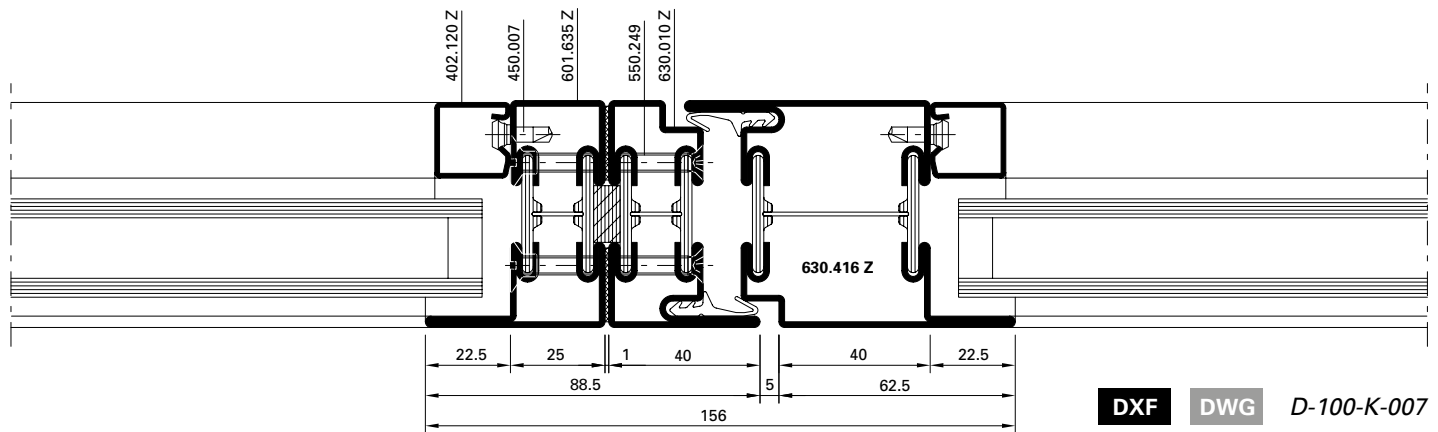

DXF **DWG** D-100-K-007

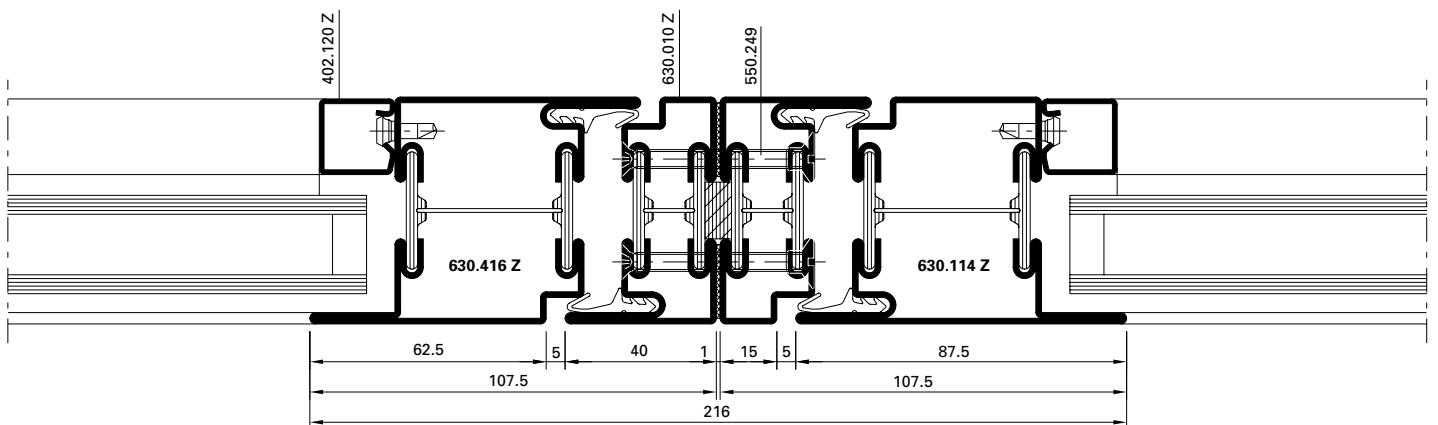

DXF **DWG** D-100-K-008

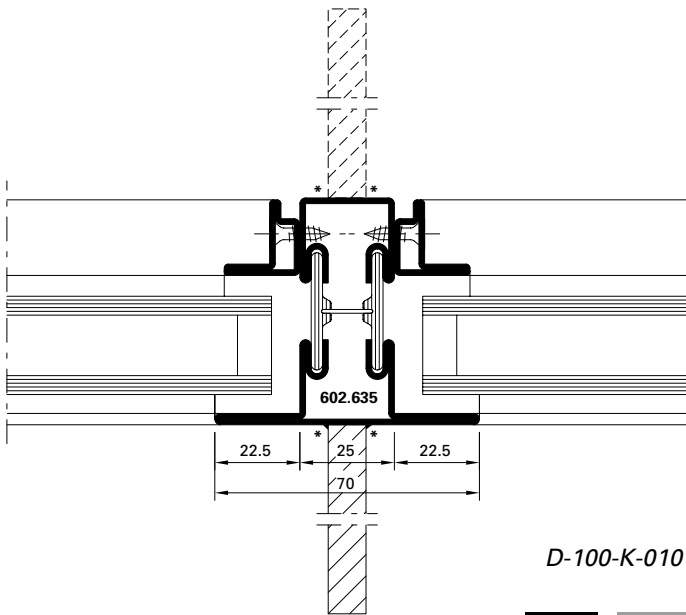

D-100-K-010

DXF DWG

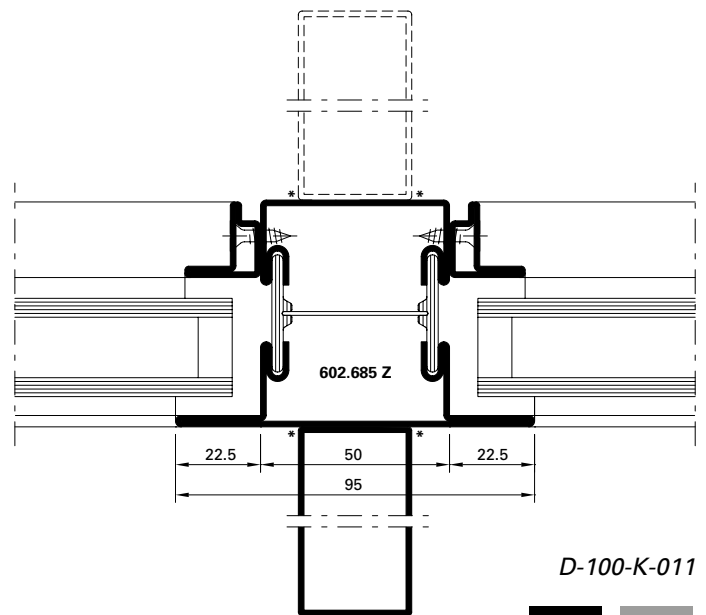

D-100-K-011

DXF DWG

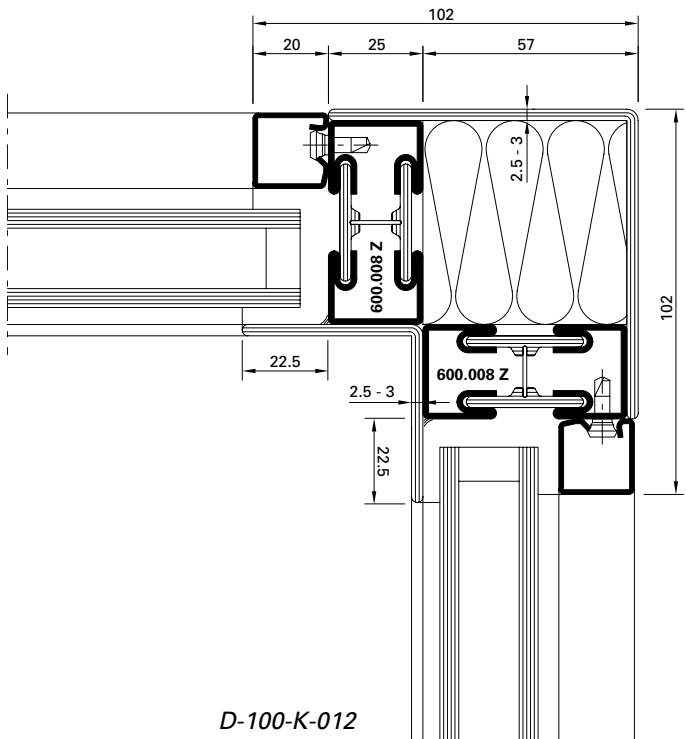

D-100-K-012

DXF DWG

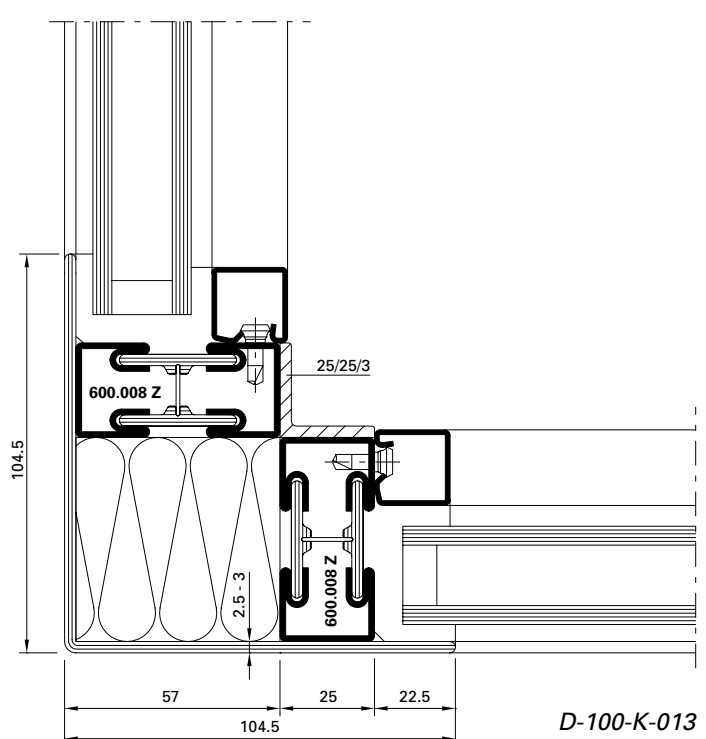

D-100-K-013

DXF DWG

* wahlweise örtliche Schweißung oder durchgehende Laserschweißung

* Au choix, soudage local à la place ou soudage au laser en continu

* Optionally, local weld or continuous laser welding

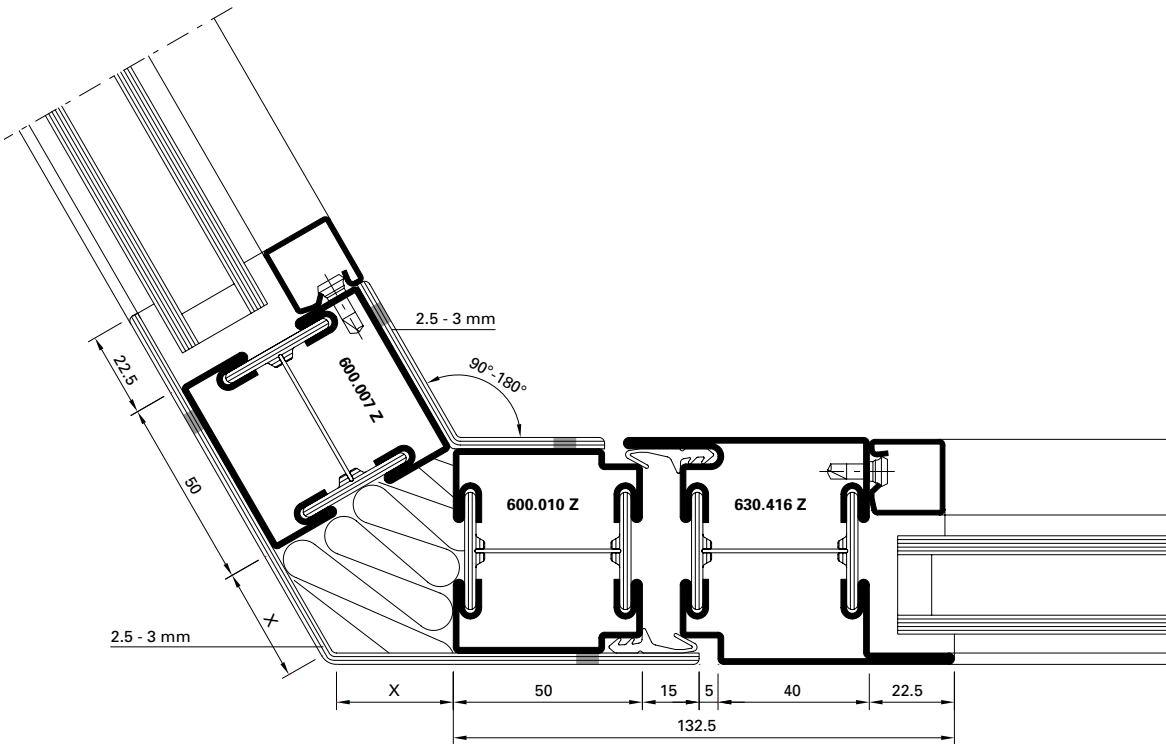

DXF **DWG** *D-100-K-014*

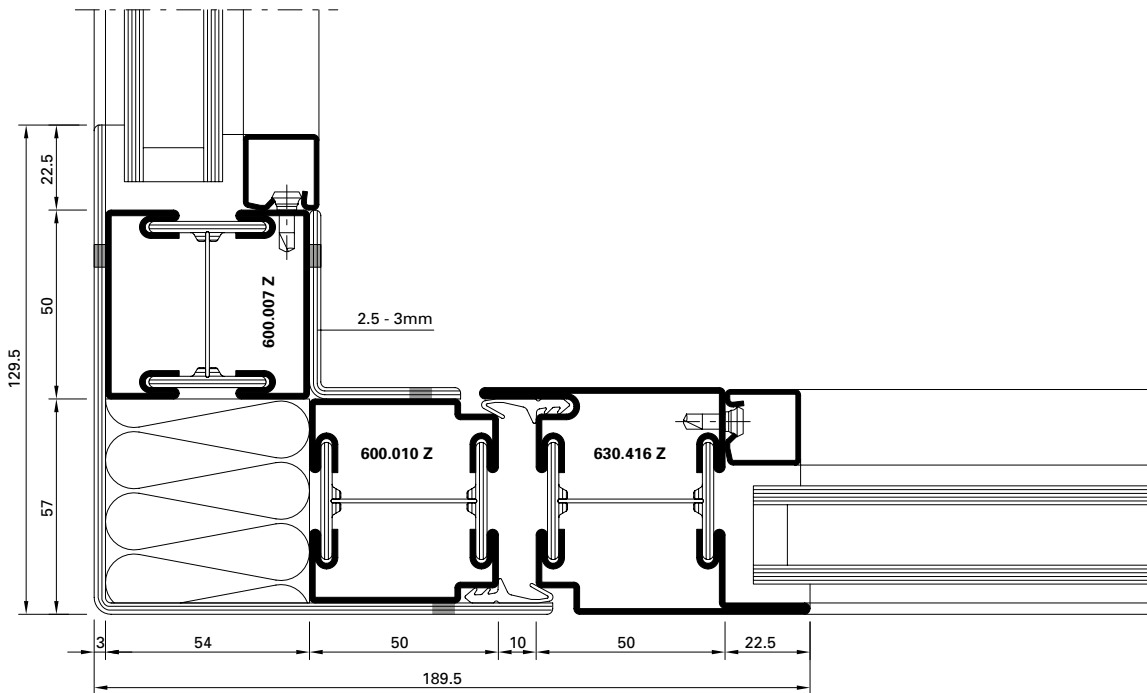

DXF **DWG** *D-100-K-015*

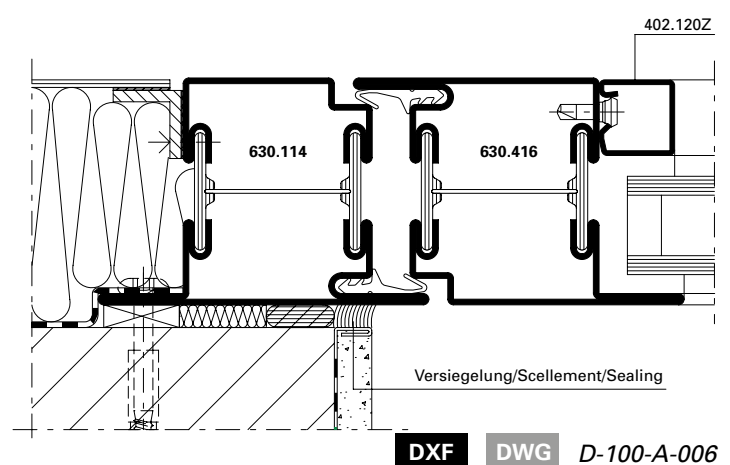
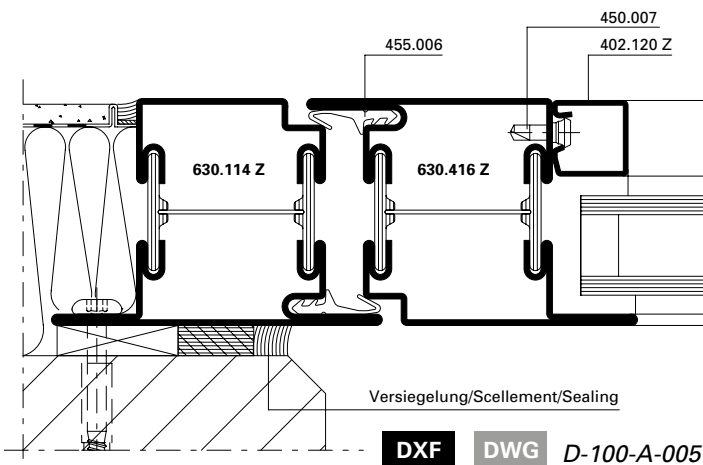
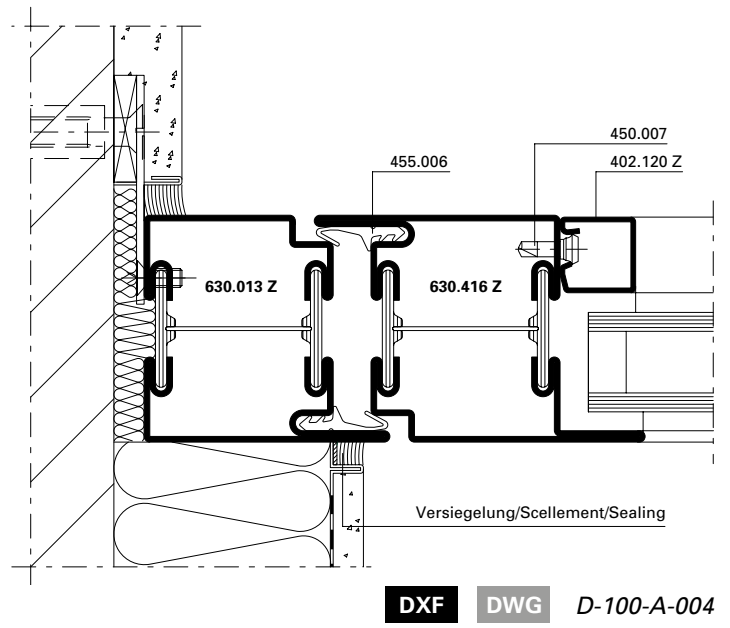
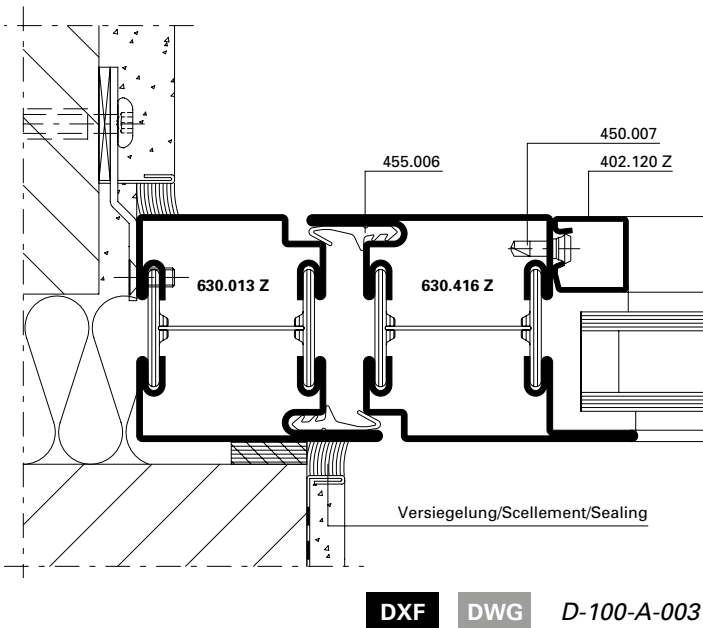
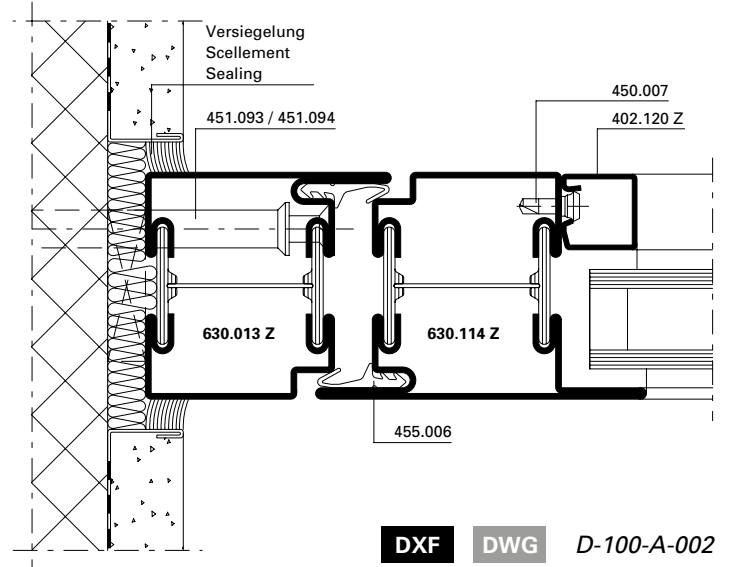
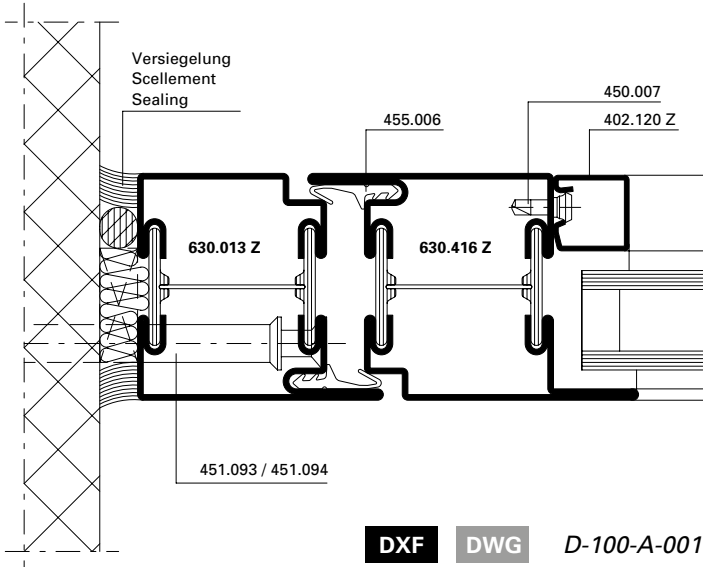

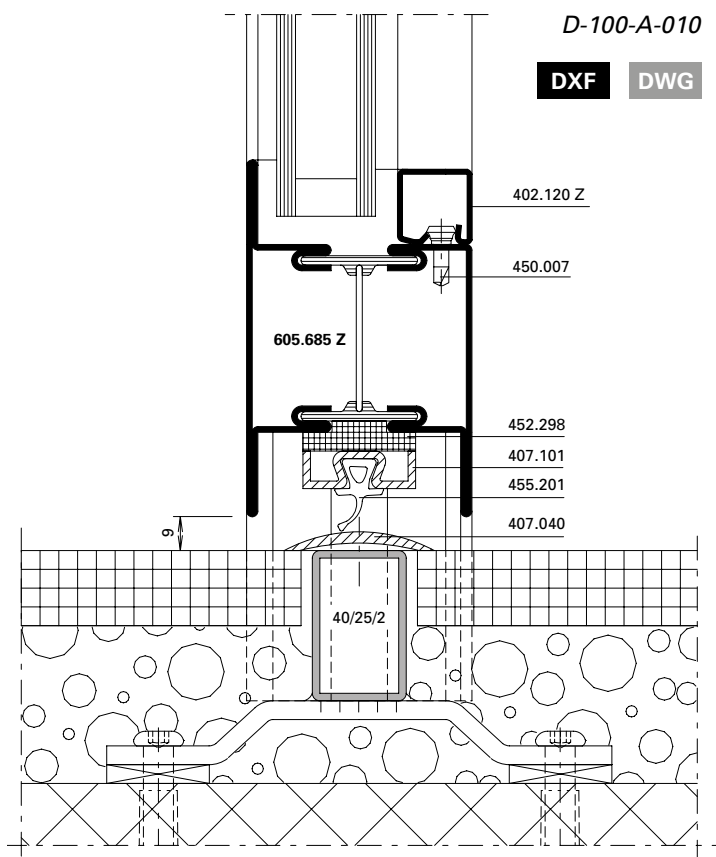
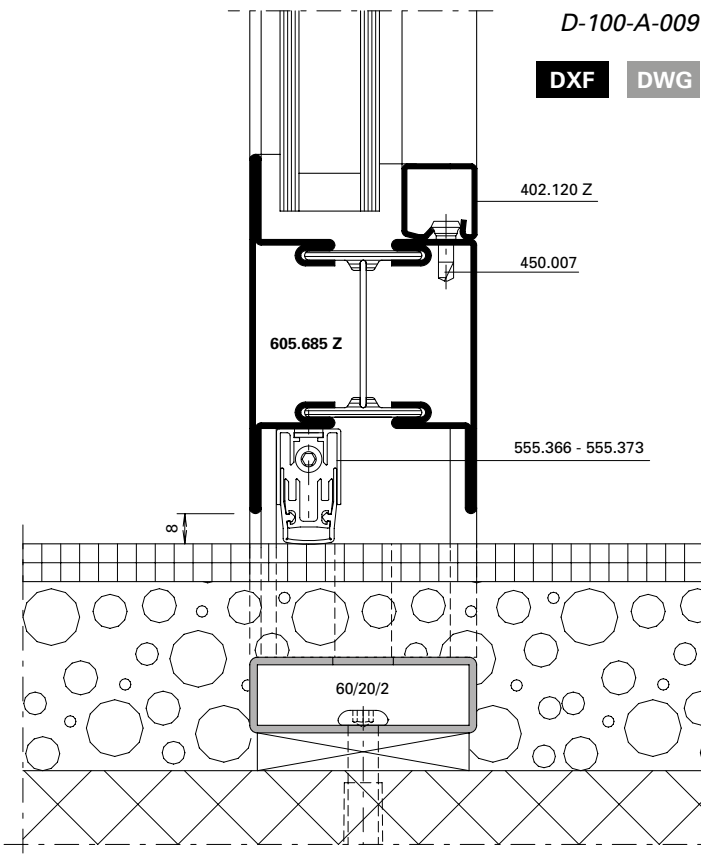
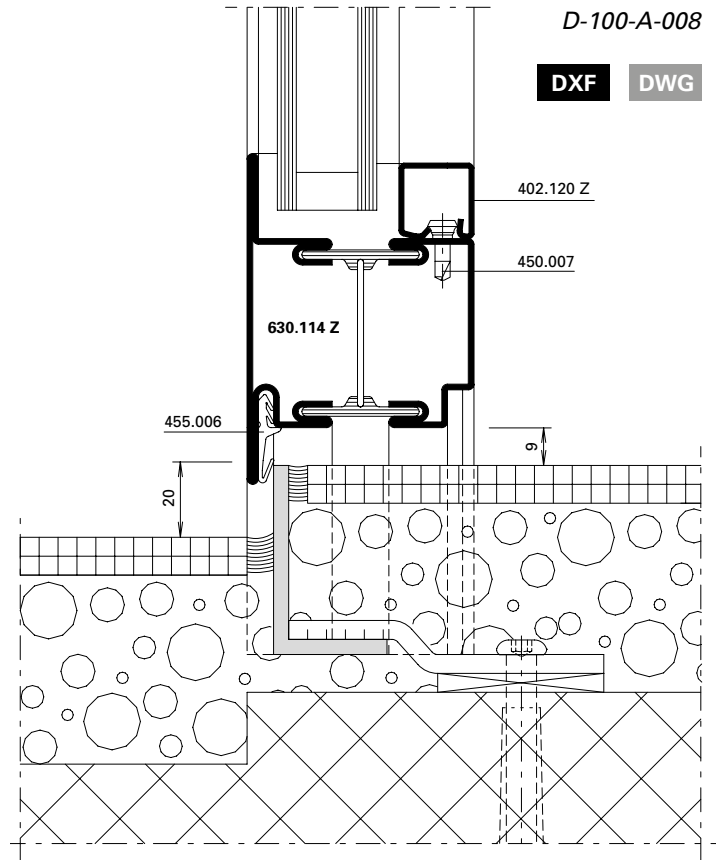
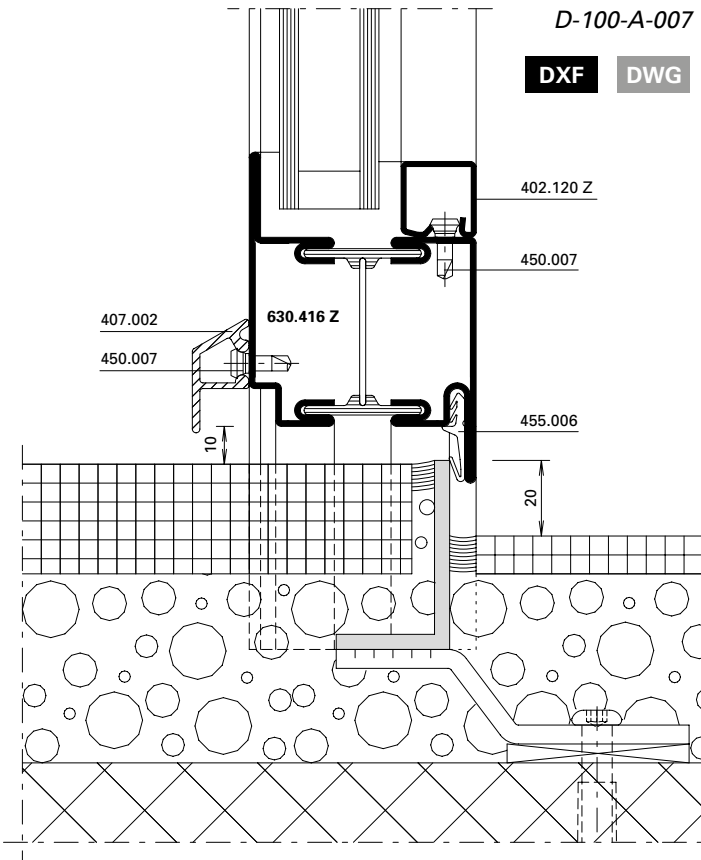

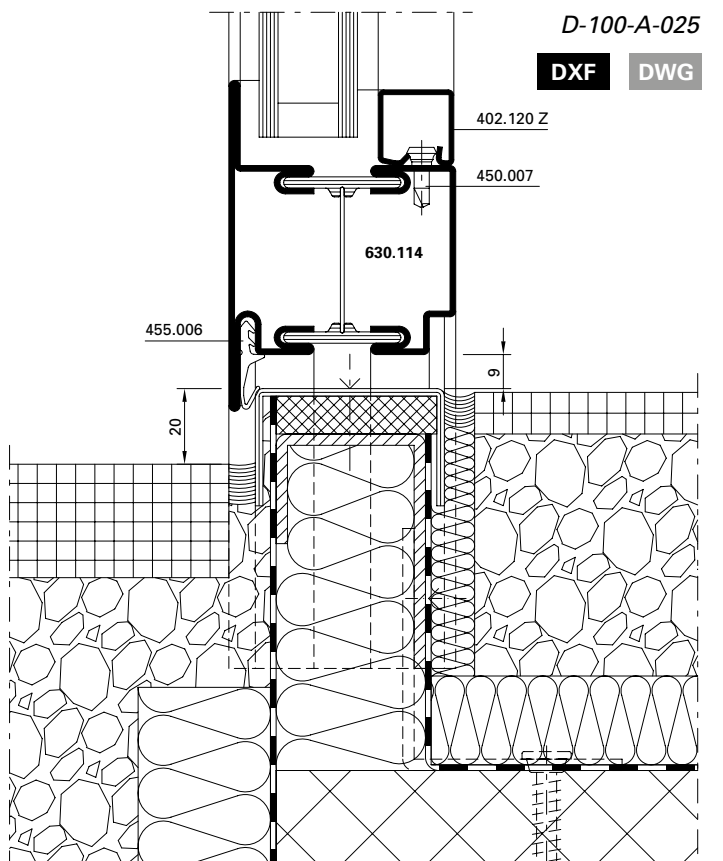
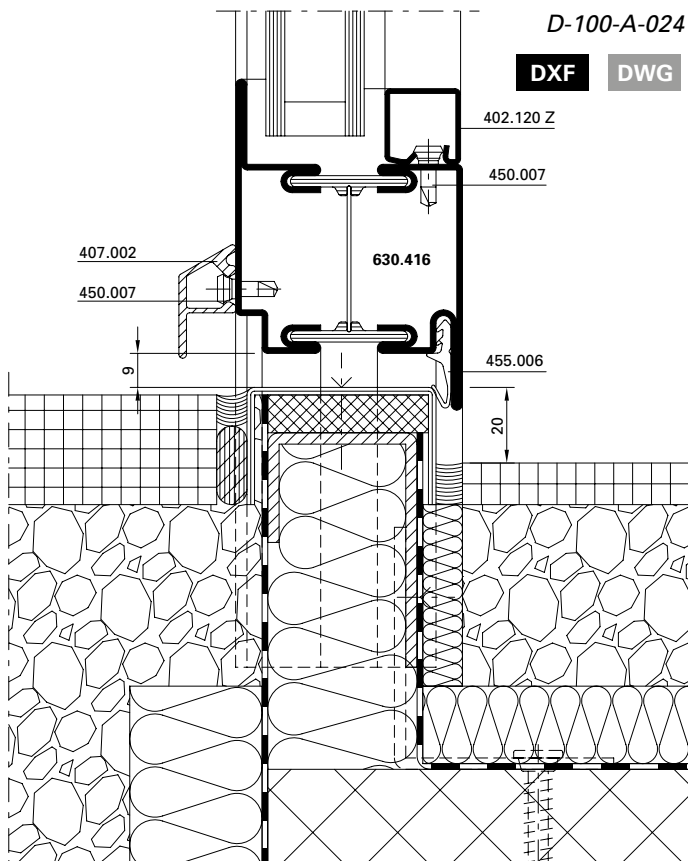
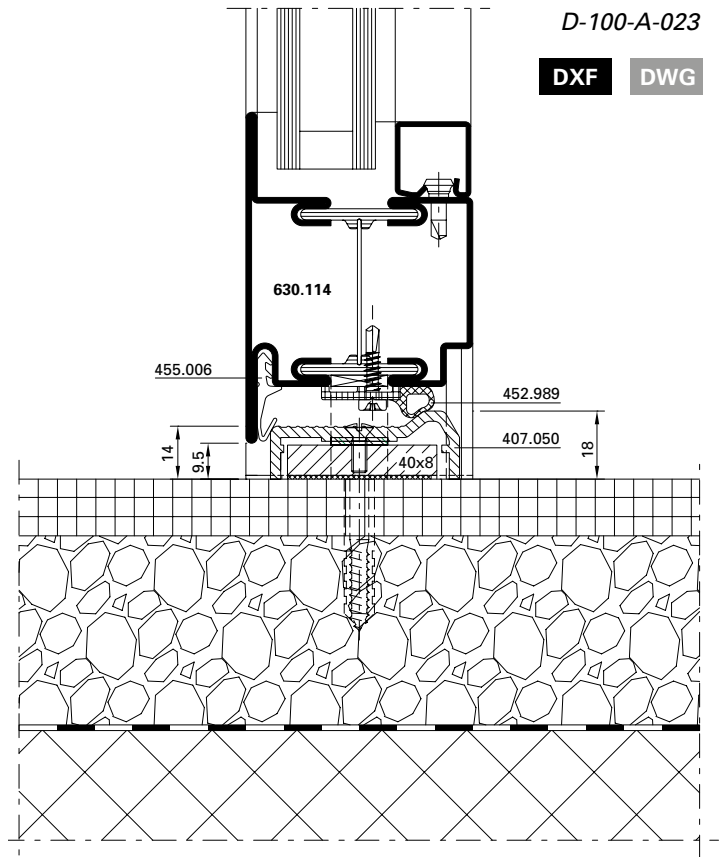
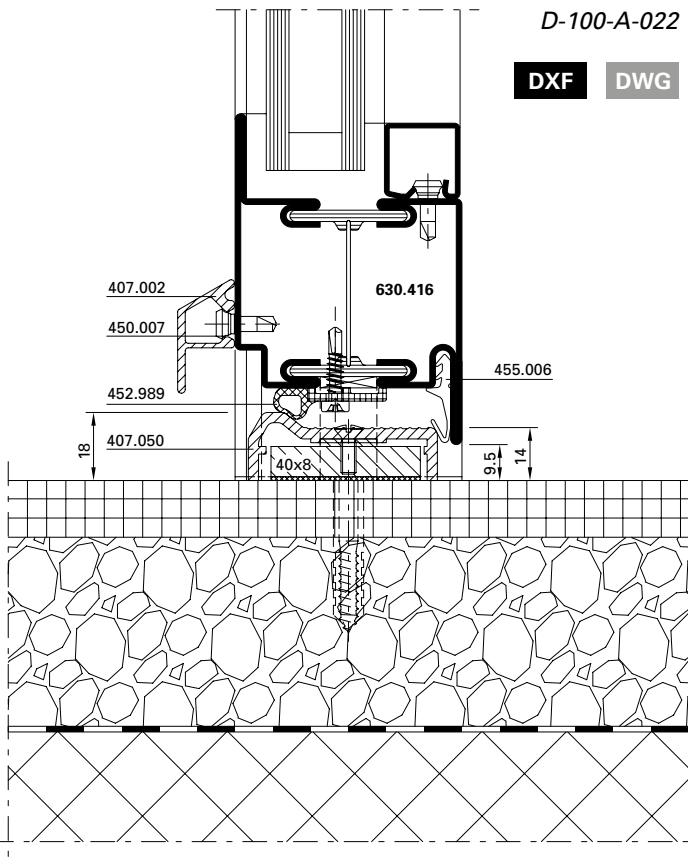

Anschlüsse am Bau im Masstab 1:2
 Raccords au mur à l'échelle 1:2
 Attachment to structure on scale 1:2

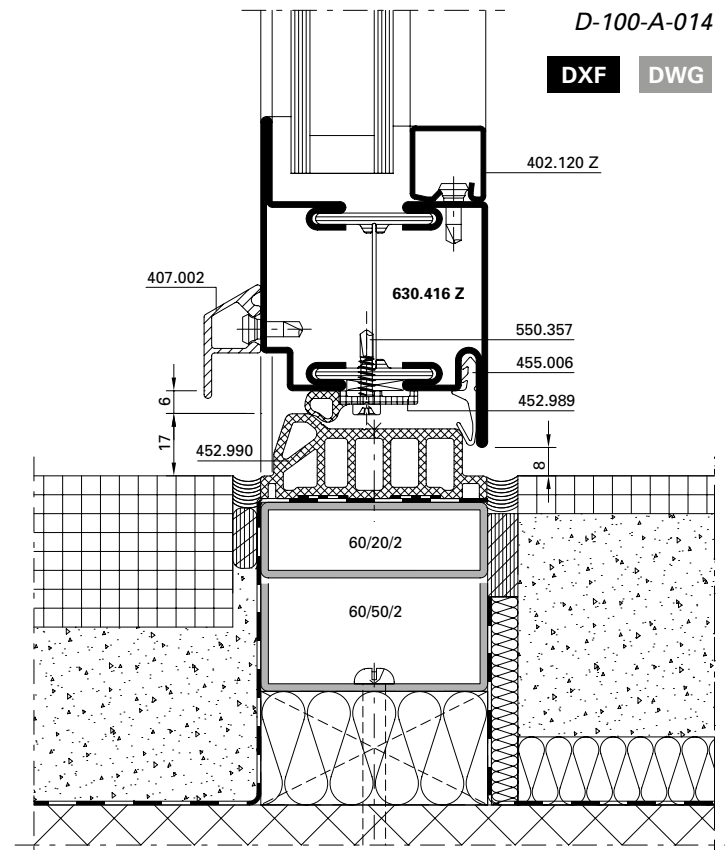
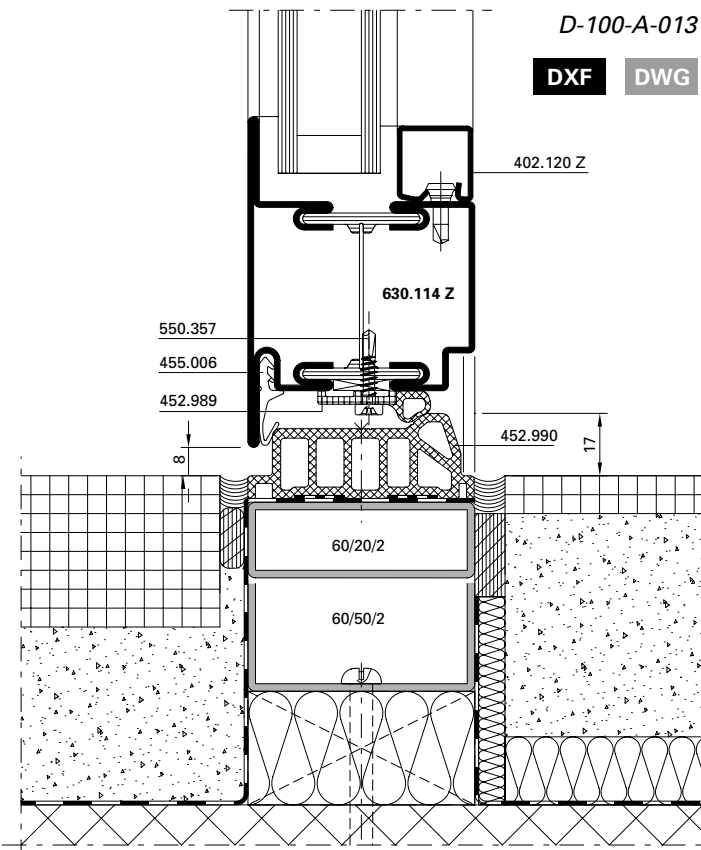
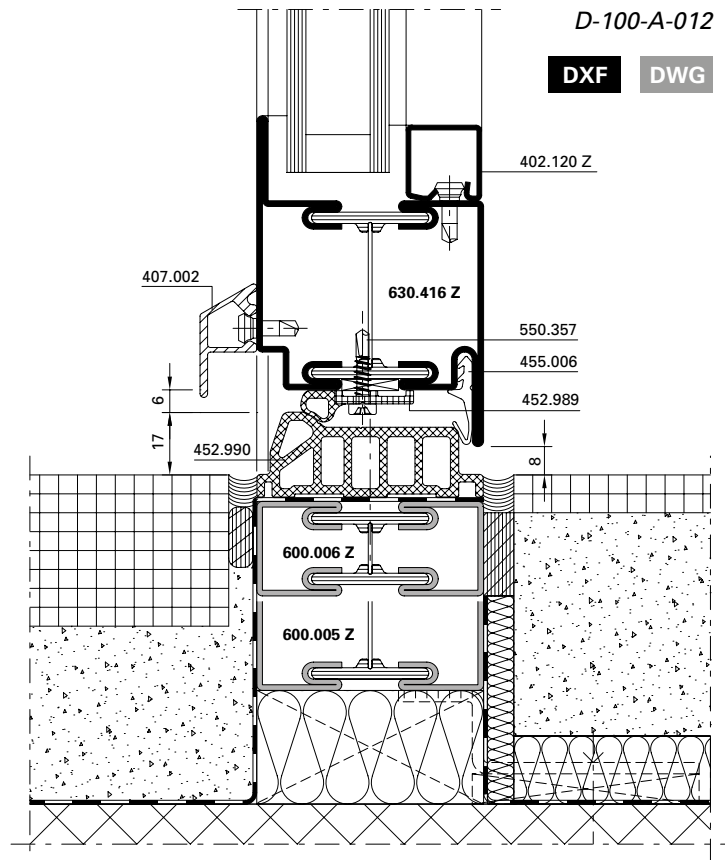
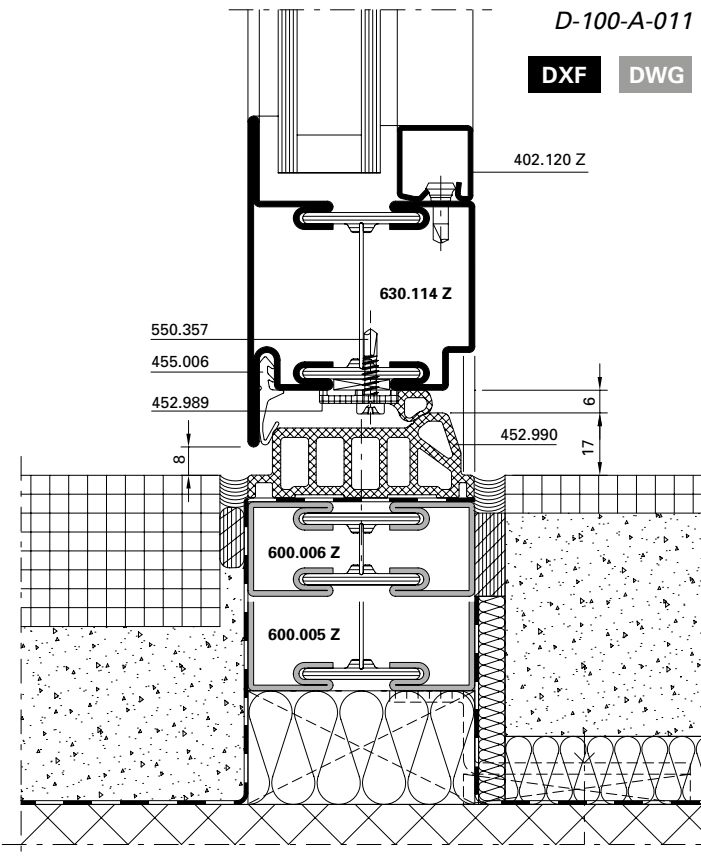

Janisol Türen
 Janisol portes
 Janisol doors



Einflügelige Türen,
 auswärts öffnend,
 Flügelhöhe ≤ 2200 mm

Porte à un vantail,
 ouvrant vers l'extérieur,
 hauteur du vantail ≤ 2200 mm

Single leaf door,
 outward opening,
 leaf height ≤ 2200 mm

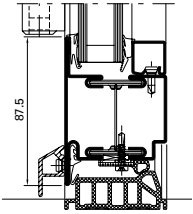
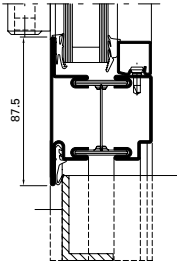
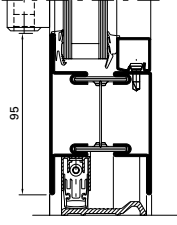
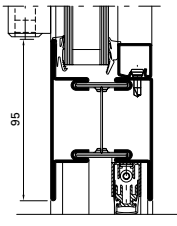
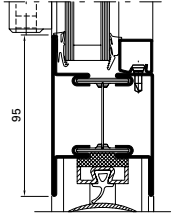
Variante	Beschlag Ferrure Fitting	 EN 12207	 EN 12208	 EN 12210
Doppel-Anschlagdichtung Joint de butée double Double rebate gasket 	1	4 / 3*	4A / 3A*	C4 / C3*
	2	4	4A / 3A*	C4 / C3*
Anschlagdichtung Joint de butée Rebate gasket 	1	2	0	C4 / C3*
	2	2	0	C4 / C3*
Senkdichtung mit Türschwellerprofil Joint seuil avec profilé pour seuil de porte Drop seal with door threshold profile 	1	2	1A	C4 / C3*
	2	2	2A	C4 / C3*
Senkdichtung Joint seuil Drop seal 	1	2	npd	C4 / C3*
	2	2	npd	C4 / C3*
Auflaufdichtung Joint de contact Ramp seal 	1	2	0	C4 / C3*
	2	2	0	C4 / C3*

1 Fallenriegel-Schloss
 Serrure à mortaiser
 Latch and bolt lock



2 Schloss mit Obenverriegelung
 Serrure avec verrouillage supérieur
 Lock with top locking point

* Edelstahl
 * Acier Inox
 * Stainless steel

Einflügelige Türen,
 einwärts öffnend,
 Flügelhöhe ≤ 2200 mm

Porte à un vantail,
 ouvrant vers l'intérieur,
 hauteur du vantail ≤ 2200 mm

Single leaf door,
 inward opening,
 leaf height ≤ 2200 mm

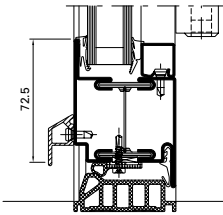
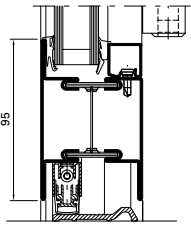
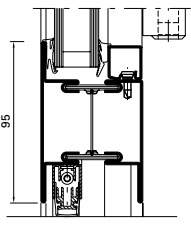
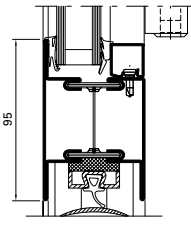
Variante	Beschlag Ferrure Fitting	 EN 12207	 EN 12208	 EN 12210
Doppel-Anschlagdichtung Joint de butée double Double rebate gasket 	1	4 / 3*	0	C4 / C3*
	2	4	2A	C4 / C3*
Senkdichtung mit Türschwelleprofil Joint seuil avec profilé pour seuil de porte Drop seal with door threshold profile 	1	2	0	C4 / C3*
	2	2	0	C4 / C3*
Senkdichtung Joint seuil Drop seal 	1	2	npd	C4 / C3*
	2	2	npd	C4 / C3*
Auflaufdichtung Joint de contact Ramp seal 	1	2	0	C4 / C3*
	2	2	0	C4 / C3*

Wetterschenkel siehe «Janisol Türen -
 Beschlageinbau und Verarbeitung»

Renvoi d'eau voir «Portes Janisol -
 Montage des ferrures et usinage»

Weatherbar see «Janisol doors -
 Installation of fittings and assembly»

1 Fallenriegel-Schloss
 Serrure à mortaiser
 Latch and bolt lock



2 Schloss mit Obenverriegelung
 Serrure avec verrouillage supérieur
 Lock with top locking point

* Edelstahl
 * Acier Inox
 * Stainless steel

Einflügelige Türen,
 auswärts öffnend,
 Flügelhöhe ≤ 3000 mm

Porte à un vantail,
 ouvrant vers l'extérieur,
 hauteur du vantail ≤ 3000 mm

Single leaf door,
 outward opening,
 leaf height ≤ 3000 mm

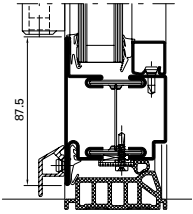
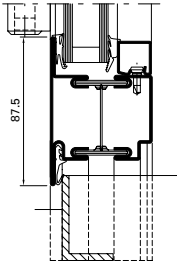
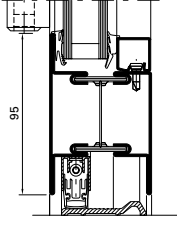
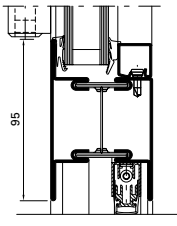
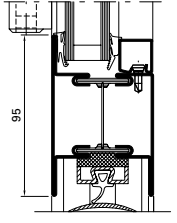
Variante	Beschlag Ferrure Fitting	 EN 12207	 EN 12208	 EN 12210	
Doppel-Anschlagdichtung Joint de butée double Double rebate gasket		1	1	1A	C1
		2	3	1A	C2
Anschlagdichtung Joint de butée Rebate gasket		1	1	npd	C1
		2	1	npd	C2
Senkdichtung mit Türschwelleprofil Joint seuil avec profilé pour seuil de porte Drop seal with door threshold profile		1	1	0	C1
		2	1	0	C2
Senkdichtung Joint seuil Drop seal		1	1	npd	C1
		2	1	npd	C2
Auflaufdichtung Joint de contact Ramp seal		1	0	0	C1
		2	0	0	C2



1 Fallenriegel-Schloss
 Serrure à mortaiser
 Latch and bolt lock

2 Schloss mit Oberverriegelung
 Serrure avec verrouillage supérieur
 Lock with top locking point

Einflügelige Türen,
 einwärts öffnend,
 Flügelhöhe ≤ 3000 mm

Porte à un vantail,
 ouvrant vers l'intérieur,
 hauteur du vantail ≤ 3000 mm

Single leaf door,
 inward opening,
 leaf height ≤ 3000 mm

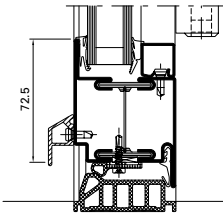
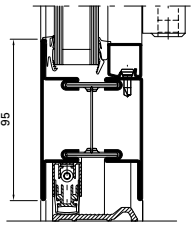
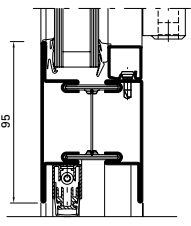
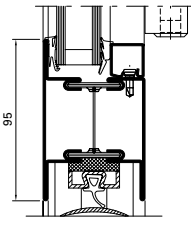
Variante	Beschlag Ferrure Fitting	 EN 12207	 EN 12208	 EN 12210
Doppel-Anschlagdichtung Joint de butée double Double rebate gasket 	1	1	npd	C1
	2	3	2A	C2
Senkdichtung mit Türschwelleprofil Joint seuil avec profilé pour seuil de porte Drop seal with door threshold profile 	1	1	0	C1
	2	1	0	C2
Senkdichtung Joint seuil Drop seal 	1	1	npd	C1
	2	1	npd	C2
Auflaufdichtung Joint de contact Ramp seal 	1	0	0	C1
	2	0	0	C2

Wetterschenkel siehe «Janisol Türen -
 Beschlageinbau und Verarbeitung»

Renvoi d'eau voir «Portes Janisol -
 Montage des ferrures et usinage»

Weatherbar see «Janisol doors -
 Installation of fittings and assembly»



1 Fallenriegel-Schloss
 Serrure à mortaiser
 Latch and bolt lock

2 Schloss mit Obenverriegelung
 Serrure avec verrouillage supérieur
 Lock with top locking point

Zweiflügelige Türen,
 auswärts öffnend,
 Flügelhöhe ≤ 2200 mm

Porte à deux vantaux,
 ouvrant vers l'extérieur,
 hauteur du vantail ≤ 2200 mm

Double leaf door,
 outward opening,
 leaf height ≤ 2200 mm

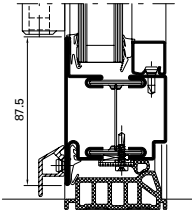
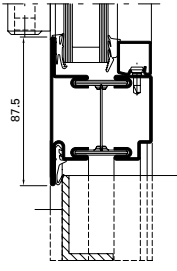
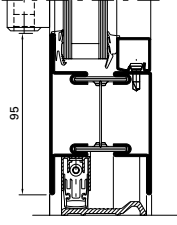
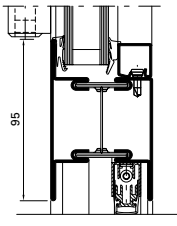
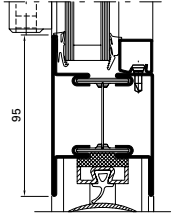
Variante	Beschlag Ferrure Fitting	 EN 12207	 EN 12208	 EN 12210
Doppel-Anschlagdichtung Joint de butée double Double rebate gasket 	1	2	2A	C2
	2	2	3A	C2
Anschlagdichtung Joint de butée Rebate gasket 	1	2	npd	C2
	2	2	npd	C2
Senkdichtung mit Türschwelleprofil Joint seuil avec profilé pour seuil de porte Drop seal with door threshold profile 	1	2	1A / 0*	C2
	2	2	2A / 0*	C2
Senkdichtung Joint seuil Drop seal 	1	2	npd	C2
	2	2	npd	C2
Auflaufdichtung Joint de contact Ramp seal 	1	2	0	C2
	2	2	0	C2

1 Fallenriegel-Schloss
 Serrure à mortaiser
 Latch and bolt lock





2 Schloss mit Oberverriegelung
 Serrure avec verrouillage supérieur
 Lock with top locking point

* Edelstahl
 * Acier Inox
 * Stainless steel

Zweiflügelige Türen,
 einwärts öffnend,
 Flügelhöhe ≤ 2200 mm

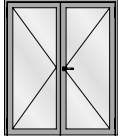
Porte à deux vantaux,
 ouvrant vers l'intérieur,
 hauteur du vantail ≤ 2200 mm

Double leaf door,
 inward opening,
 leaf height ≤ 2200 mm

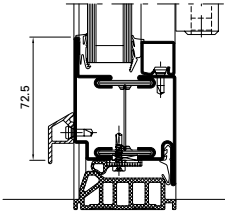
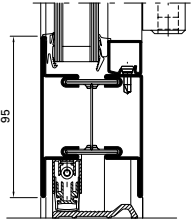
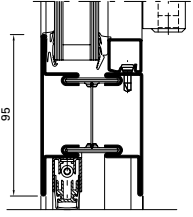
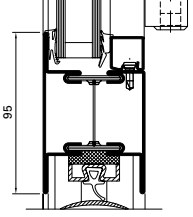
Variante		Beschlag Ferrure Fitting	 EN 12207	 EN 12208	 EN 12210
Doppel-Anschlagdichtung Joint de butée double Double rebate gasket		❶	2	0	C2
		❷	2	0	C2
Senkdichtung mit Türschwelleprofil Joint seuil avec profilé pour seuil de porte Drop seal with door threshold profile		❶	2	0	C2
		❷	2	0	C2
Senkdichtung Joint seuil Drop seal		❶	2	npd	C2
		❷	2	npd	C2
Auflaufdichtung Joint de contact Ramp seal		❶	2	0	C2
		❷	2	0	C2

Wetterschenkel siehe «Janisol Türen -
 Beschlageinbau und Verarbeitung»

Renvoi d'eau voir «Portes Janisol -
 Montage des ferrures et usinage»

Weatherbar see «Janisol doors -
 Installation of fittings and assembly»



❶ Fallenriegel-Schloss
 Serrure à mortaiser
 Latch and bolt lock

❷ Schloss mit Obenverriegelung
 Serrure avec verrouillage supérieur
 Lock with top locking point

Zweiflügelige Türen,
 auswärts öffnend,
 Flügelhöhe ≤ 3000 mm

Porte à deux vantaux,
 ouvrant vers l'extérieur,
 hauteur du vantail ≤ 3000 mm

Double leaf door,
 outward opening,
 leaf height ≤ 3000 mm

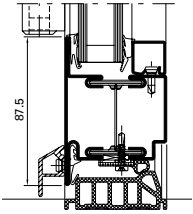
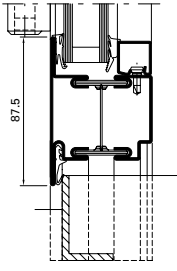
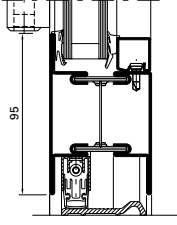
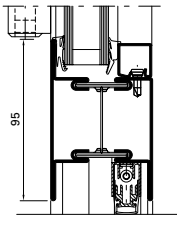
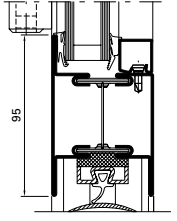
Variante	Beschlag Ferrure Fitting	 EN 12207	 EN 12208	 EN 12210
Doppel-Anschlagdichtung Joint de butée double Double rebata gasket 	1	0	0	C1
	2	0	0	C1
Anschlagdichtung Joint de butée Rebata gasket 	1	0	npd	C1
	2	0	npd	C1
Senkdichtung mit Türschwelenprofil Joint seuil avec profilé pour seuil de porte Drop seal with door threshold profile 	1	0	0	C1
	2	0	0	C1
Senkdichtung Joint seuil Drop seal 	1	0	npd	C1
	2	0	npd	C1
Auflaufdichtung Joint de contact Ramp seal 	1	0	0	C1
	2	0	0	C1





1 Fallenriegel-Schloss
 Serrure à mortaiser
 Latch and bolt lock

2 Schloss mit Oberverriegelung
 Serrure avec verrouillage supérieur
 Lock with top locking point

Zweiflügelige Türen,
 einwärts öffnend,
 Flügelhöhe ≤ 3000 mm

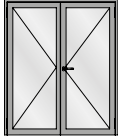
Porte à deux vantaux,
 ouvrant vers l'intérieur,
 hauteur du vantail ≤ 3000 mm

Double leaf door,
 inward opening,
 leaf height ≤ 3000 mm

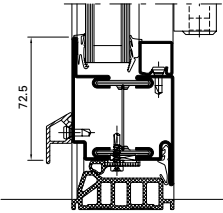
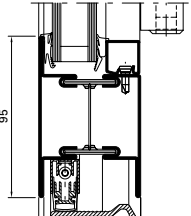
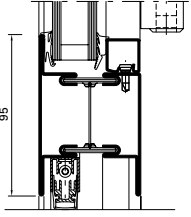
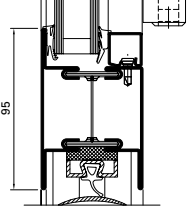
Variante		Beschlag Ferrure Fitting	 EN 12207	 EN 12208	 EN 12210
Doppel-Anschlagdichtung Joint de butée double Double rebate gasket		❶	0	0	C1
		❷	0	0	C1
Senkdichtung mit Türschwelleprofil Joint seuil avec profilé pour seuil de porte Drop seal with door threshold profile		❶	0	0	C1
		❷	0	0	C1
Senkdichtung Joint seuil Drop seal		❶	0	npd	C1
		❷	0	npd	C1
Auflaufdichtung Joint de contact Ramp seal		❶	0	0	C1
		❷	0	0	C1

Wetterschenkel siehe «Janisol Türen -
 Beschlageinbau und Verarbeitung»

Renvoi d'eau voir «Portes Janisol -
 Montage des ferrures et usinage»

Weatherbar see «Janisol doors -
 Installation of fittings and assembly»

❶ Fallenriegel-Schloss
 Serrure à mortaiser
 Latch and bolt lock

❷ Schloss mit Obenverriegelung
 Serrure avec verrouillage supérieur
 Lock with top locking point

U_f-Werte
(nach EN ISO 10077-2:2018-01)

Valeurs U_f
(selon EN ISO 10077-2:2018-01)

U_f values
(according to
EN ISO 10077-2:2018-01)

Auf den folgenden Seiten finden Sie die U_f-Werte für die verschiedenen Anwendungen von Janisol-Türen.

Vous trouverez les valeurs U_f pour les différentes applications Janisol portes. dans les pages qui suivent.

On the following pages you will find the U_f values for the various applications for Janisol doors.

Sie basieren auf folgenden Grundlagen:

Elles se basent sur les principes suivants:

They are based on the following:

- Stahl**
- Profile bandverzinkter Stahl, unbeschichtet
 - Stahl-Glasleisten
 - Trockenverglasung

- Acier**
- Profilés en bande d'acier zingué, sans revêtement
 - Parcloses en acier
 - Vitrage à sec

- Steel**
- Strip galvanised steel profiles, uncoated
 - Steel glazing beads
 - Glazing with dry glazing

- Edelstahl**
- Profile Edelstahl, blank
 - Edelstahl-Glasleisten
 - Trockenverglasung

- Acier Inox**
- Profilés en acier Inox, brut
 - Parcloses en acier Inox
 - Vitrage à sec

- Stainless steel**
- Stainless steel profiles, bright
 - Stainless steel glazing beads
 - Glazing with dry glazing

Janisol-Türen Stahl
Zweifach-Isolierglas

Janisol portes acier
Double verre isolant

Janisol doors steel
Double insulating glazing

Janisol Türen Edelstahl
Zweifach-Isolierglas

Janisol portes acier Inox
Double verre isolant

Janisol doors acier Inox
Double insulating glazing

U_f-Werte
 (nach EN ISO 10077-2:2018-01)

Valeurs U_f
 (selon EN ISO 10077-2:2018-01)

U_f values
 (according to EN ISO 10077-2:2018-01)

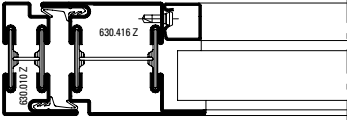
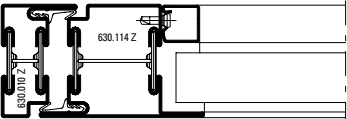
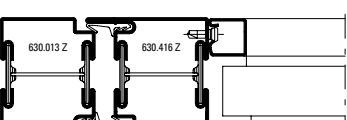
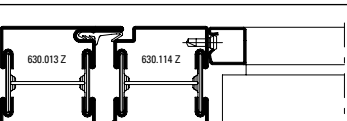
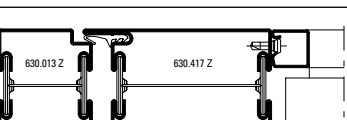
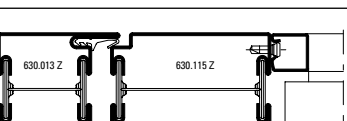
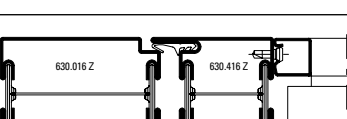
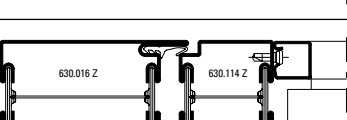
	Füllelementstärken Elements de remplissages Infill elements ≥ 24 mm
	2,6 W/m ² K
	2,6 W/m ² K
	2,4 W/m ² K
	2,4 W/m ² K
	2,2 W/m ² K
	2,2 W/m ² K
	2,2 W/m ² K
	2,2 W/m ² K

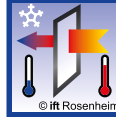
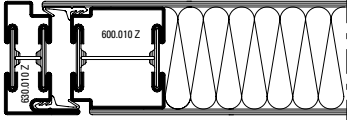
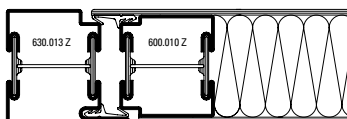
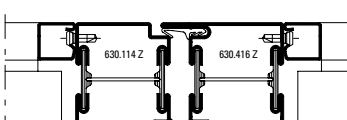
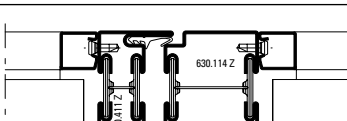
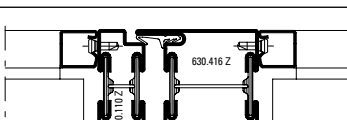
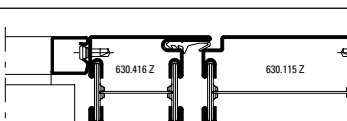
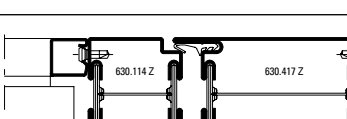
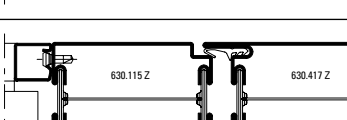
	Füllelementstärken Elements de remplissages Infill elements ≥ 24 mm
	2,7 W/m ² K
	2,4 W/m ² K
	2,4 W/m ² K
	2,6 W/m ² K
	2,6 W/m ² K
	2,2 W/m ² K
	2,2 W/m ² K
	2,0 W/m ² K

U_f-Werte
 (nach EN ISO 10077-2:2018-01)

Valeurs U_f
 (selon EN ISO 10077-2:2018-01)

U_f values
 (according to EN ISO 10077-2:2018-01)

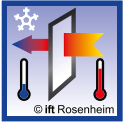
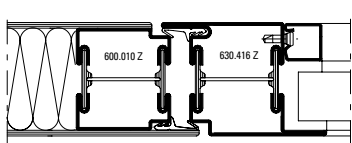
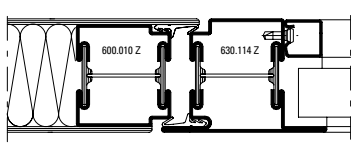
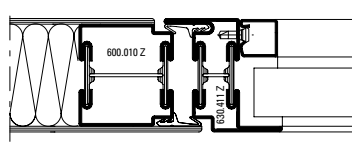
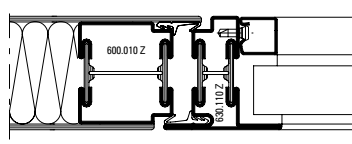
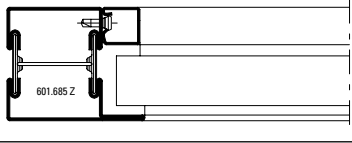
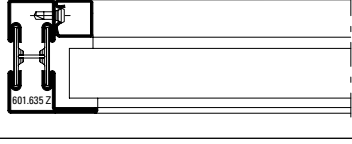
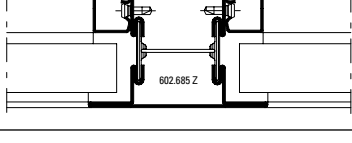
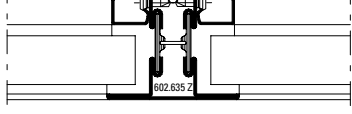
 Füllelementstärken Elements de remplissages Infill elements ≥ 24 mm	
	2,4 W/m²K
	2,4 W/m²K
	2,7 W/m²K
	2,7 W/m²K
	2,3 W/m²K
	2,8 W/m²K
	2,3 W/m²K
	2,6 W/m²K

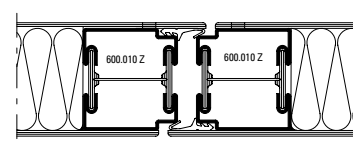
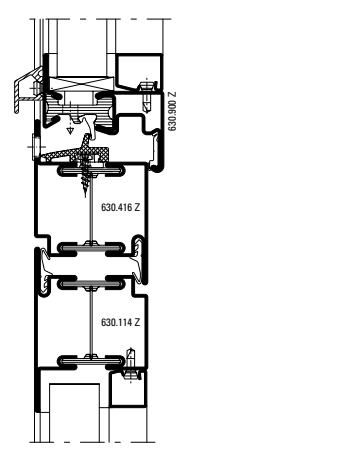
 Füllelementstärken Elements de remplissages Infill elements ≥ 24 mm	
	2,5 W/m²K
	2,5 W/m²K

U_f-Werte
 (nach EN ISO 10077-2:2018-01)

Valeurs U_f
 (selon EN ISO 10077-2:2018-01)

U_f values
 (according to EN ISO 10077-2:2018-01)

	Füllelementstärken Elements de remplissages Infill elements ≥ 24 mm
	2,2 W/m ² K (links / gauche / left) 2,3 W/m ² K (rechts / droite / right)
	3,4 W/m ² K (links / gauche / left) 2,9 W/m ² K (rechts / droite / right)
	3,1 W/m ² K (links / gauche / left) 2,9 W/m ² K (rechts / droite / right)
	3,3 W/m ² K (links / gauche / left) 3,4 W/m ² K (rechts / droite / right)

	Füllelementstärken Elements de remplissages Infill elements ≥ 24 mm
	2,6 W/m ² K
	1,9 W/m ² K

U_f-Werte
 (nach EN ISO 10077-2:2018-01)

Valeurs U_f
 (selon EN ISO 10077-2:2018-01)

U_f values
 (according to EN ISO 10077-2:2018-01)

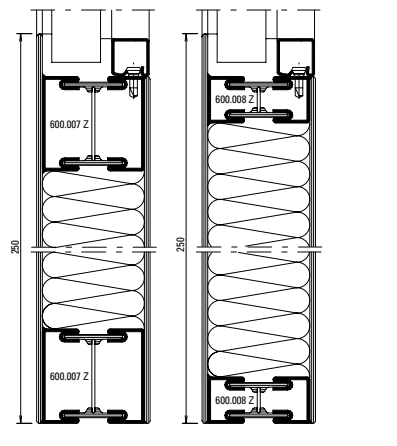
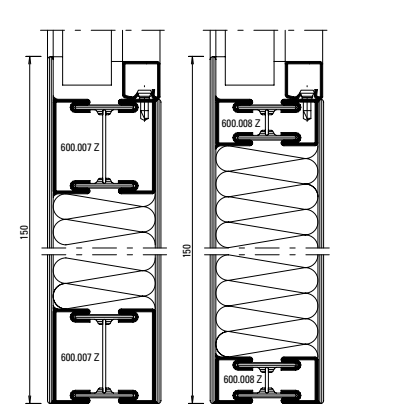
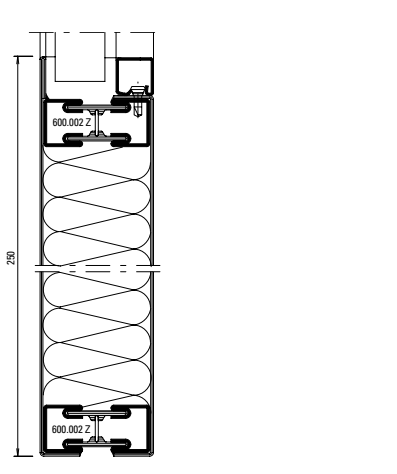
	Füllelementstärken Elements de remplissages Infill elements ≥ 24 mm
	1,6 W/m ² K
	2,2 W/m ² K (links / gauche / left) 2,1 W/m ² K (rechts / droite / right)
	1,5 W/m ² K

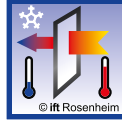
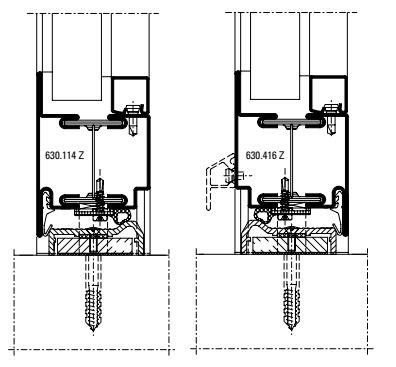
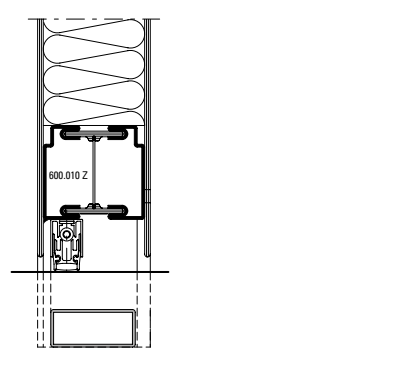
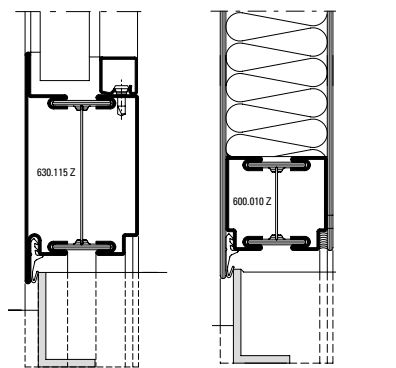
	Füllelementstärken Elements de remplissages Infill elements ≥ 24 mm
	3,3 W/m ² K (links / gauche / left) 3,2 W/m ² K (rechts / droite / right)
	3,4 W/m ² K
	2,8 W/m ² K (links / gauche / left) 4,4 W/m ² K (rechts / droite / right)

U_f-Werte Edelstahl-Profil
 (nach EN ISO 10077-2:2018-01)

Profils acier Inox valeurs U_f
 (selon EN ISO 10077-2:2018-01)

Stainless steel profiles U_f values
 (according to EN ISO 10077-2:2018-01)

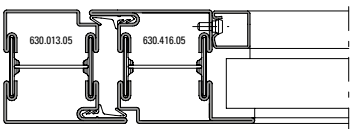
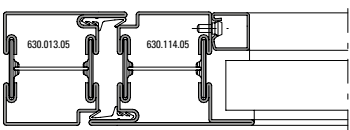
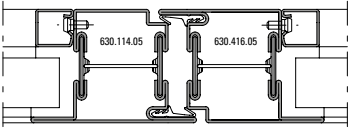
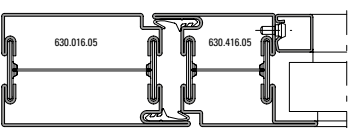
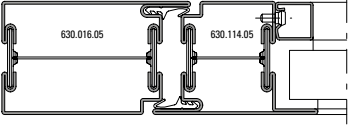
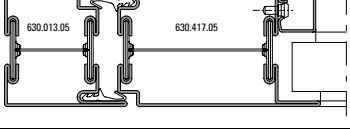
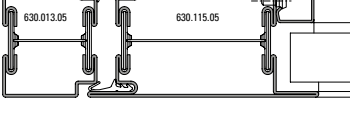

	Füllelementstärken Elements de remplissages Infill elements ≥ 24 mm
	2,3 W/m ² K
	2,3 W/m ² K
	2,3 W/m ² K
	2,1 W/m ² K
	2,0 W/m ² K
	2,0 W/m ² K
	2,0 W/m ² K

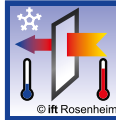
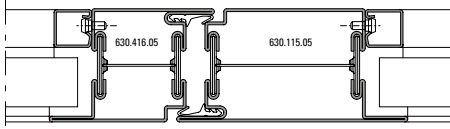
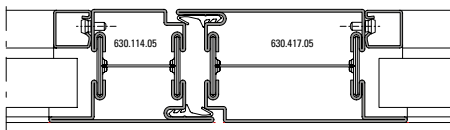
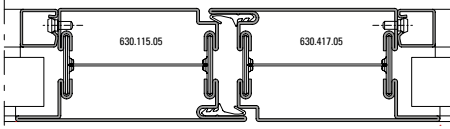
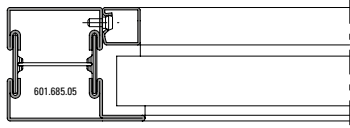
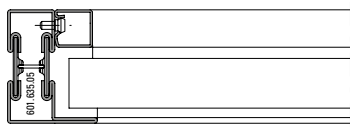
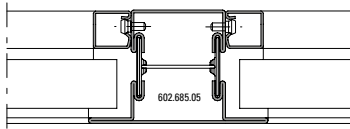
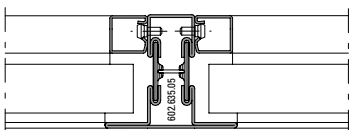
	Füllelementstärken Elements de remplissages Infill elements ≥ 24 mm
	2,1 W/m ² K
	2,1 W/m ² K
	1,9 W/m ² K
	2,2 W/m ² K
	2,7 W/m ² K
	2,2 W/m ² K
	2,5 W/m ² K

U_f-Werte Edelstahl-Profil
 (nach EN ISO 10077-2:2018-01)

Profils acier Inox valeurs U_f
 (selon EN ISO 10077-2:2018-01)

Stainless steel profiles U_f values
 (according to EN ISO 10077-2:2018-01)

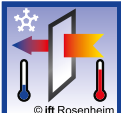
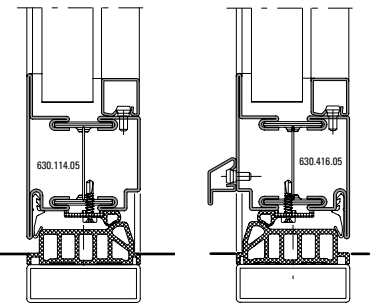
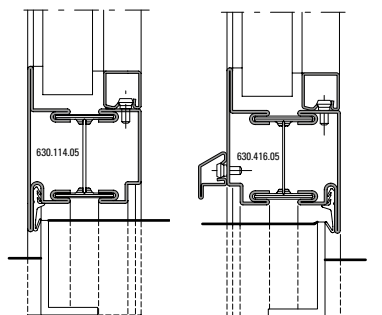
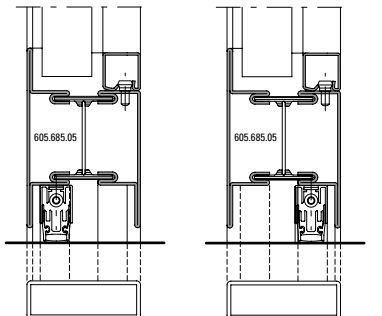
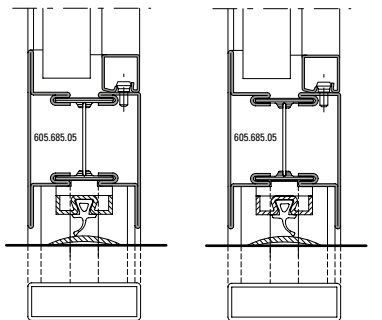

 © ift Rosenheim	Füllelementstärken Elements de remplissages Infill elements ≥ 24 mm
	2,2 W/m ² K
	3,3 W/m ² K (links / gauche / left) 2,8 W/m ² K (rechts / droite / right)
	2,9 W/m ² K (links / gauche / left) 2,7 W/m ² K (rechts / droite / right)
	3,1 W/m ² K (links / gauche / left) 3,2 W/m ² K (rechts / droite / right)

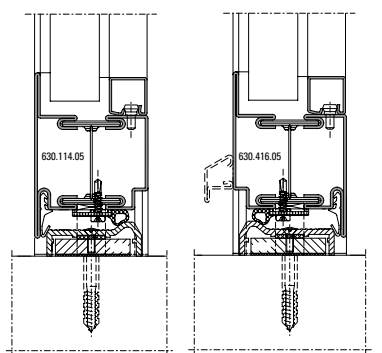
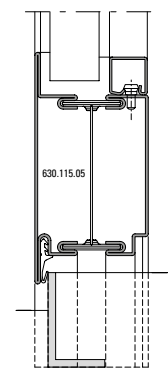
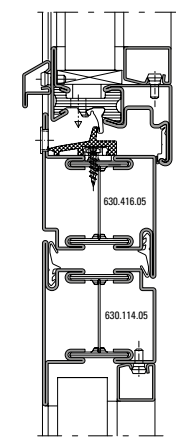
 © ift Rosenheim	Füllelementstärken Elements de remplissages Infill elements ≥ 24 mm
	3,3 W/m ² K (links / gauche / left) 3,1 W/m ² K (rechts / droite / right)
	3,0 W/m ² K
	2,4 W/m ² K

Verhalten zwischen unterschiedlichen Klimaten nach EN 1121

Comportement entre différents climats selon EN 1121

Behaviour between different climates in accordance with EN 1121

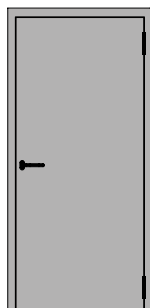



Verblechte einflügelige Türe nach aussen öffnend
 Breite: 1490 mm
 Höhe: 3039 mm

Porte tôlée à un vantail ouvrant vers l'extérieur
 Largeur: 1490 mm
 Hauteur: 3039 mm

Sheet metal single leaf door outward opening
 Width: 1490 mm
 Height: 3039 mm



Einfallen-Schloss
Serrure à un point
Single bolt lock

Norm	Eigenschaft Caractéristique Characteristic	Klassifizierung Classification Classification
 EN 12217	Bedienungskräfte Forces de manœuvre Operating forces	2
 EN 12219	Differenzklimaverhalten d ($\Delta T 38^\circ$) Résistance aux changements de température d ($\Delta T 38^\circ$) Resistance to change in temperature d ($\Delta T 38^\circ$)	B2 / C3 (4 / 1)*
 EN 12219	Differenzklimaverhalten e ($\Delta T 55^\circ$) Résistance aux changements de température e ($\Delta T 55^\circ$) Resistance to change in temperature e ($\Delta T 55^\circ$)	B0 / C2 (- / 2)*

Fallenriegel-Schloss mit Obenverriegelung

Serrure à mortaiser avec verrouillage supérieur

Latch and bolt lock with top locking point

Norm	Eigenschaft Caractéristique Characteristic	Klassifizierung Classification Classification
 EN 12217	Bedienungskräfte Forces de manœuvre Operating forces	2
 EN 12219	Differenzklimaverhalten d ($\Delta T 38^\circ$) Résistance aux changements de température d ($\Delta T 38^\circ$) Resistance to change in temperature d ($\Delta T 38^\circ$)	B1 / C3 (8 / 1)*
 EN 12219	Differenzklimaverhalten e ($\Delta T 55^\circ$) Résistance aux changements de température e ($\Delta T 55^\circ$) Resistance to change in temperature e ($\Delta T 55^\circ$)	B0 / C1 (- / 4)*

- * max. zulässige Verformung:
(Längskrümmung/Querkrümmung in mm)
- * Déformation max. admissible :
(courbure en long/en travers en mm)
- * Max. permissible deformation:
(longitudinal curvature/transverse curvature in mm)

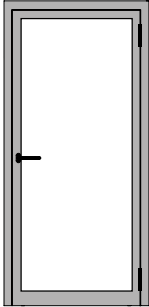

**Fallenriegel-
Schloss mit
Obenverriegelung**

**Serrure à mortaiser
avec verrouillage
supérieur**

**Latch and bolt
lock with top
locking point**

Einflügelige Türe nach aussen öffnend



Breite: 1430 mm / Höhe: 2863 mm

Porte à un vantail ouvrant vers l'extérieur

Largeur: 1430 mm / Hauteur: 2863 mm

Single leaf door outward opening

Width: 1430 mm / Height: 2863 mm

Norm	Eigenschaft Caractéristique Characteristic	Klassifizierung Classification Classification
 EN 12217	Bedienungskräfte Forces de manœuvre Operating forces	2
 EN 12219	Differenzklimaverhalten d ($\Delta T 38^\circ$) Résistance aux changements de température d ($\Delta T 38^\circ$) Resistance to change in temperature d ($\Delta T 38^\circ$)	B3 / C2 (2 / 2)*
 EN 12219	Differenzklimaverhalten e ($\Delta T 55^\circ$) Résistance aux changements de température e ($\Delta T 55^\circ$) Resistance to change in temperature e ($\Delta T 55^\circ$)	B2 / C3 (4 / 1)*

- * max. zulässige Verformung:
(Längskrümmung/Querkrümmung in mm)
- * Déformation max. admissible :
(courbure en long/en travers en mm)
- * Max. permissible deformation:
(longitudinal curvature/transverse curvature in mm)



Schallschutz

Ausführungsvarianten

Die nachfolgende Typenübersicht ergibt einen Überblick über die beurteilten Varianten.

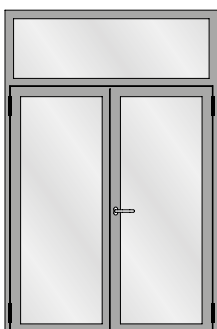
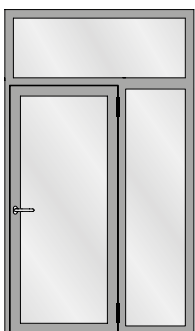
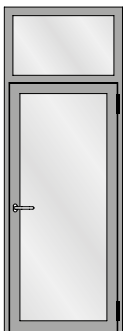
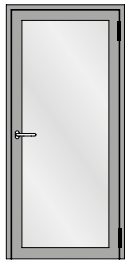

Isolation phonique

Modèles

L'aperçu des types suivant fournit une vue d'ensemble des variantes examinées.

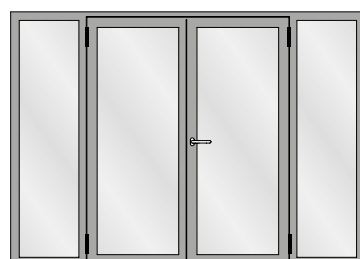
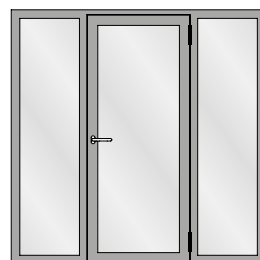
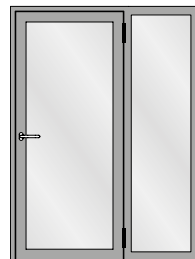
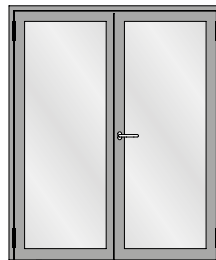

Sound insulation

Design range

The following overview of types provides an overview of the evaluated designs.



Tabelle A1
 Korrekturtabelle für Janisol-Türen
 mit Mehrscheiben-Isolierglas

Tableau A1
 Tableau de correction pour les portes
 Janisol avec vitrage isolant multi-vitres

Table A1
 Correction table for Janisol doors
 with multi-pane insulating glass

1	2	3	4	5	6	7	8	9	10	11	12
Türe 0,99 x 2,12 m mit zwei absenkbaren Bodendichtungen Porte 0,99 x 2,12 m avec deux joint seuil automatique Door 0,99 x 2,12 m with two threshold gaskets that can be lowered R_W (C, Ctr) dB	Glas Verre Glass R_{W, P, Glas} dB	Korrekturen Corrections Corrections K_S dB									
		K_{FV} dB	K_{Nass} dB	K_{1aB} dB	K_{W/S-1} dB	K_{W/S-2} dB	K_{G 0,4} dB	K_{G 1,8} dB	K_{G 2,6} dB	K_{G 3,2} dB	
1	31	0	-1	0	-1	0	0	0	-1	-2	-3
2	32	0	-1	0	-1	0	0	0	-1	-2	-3
3	34	0	-1	0	-1	0	0	0	-1	-2	-3
4	35	0	-1	-1	-1	0	0	0	-1	-2	-3
5	37	0	0	-1	-2	0	-1	0	-1	-2	-3
6	38	0	0	-1	-2	0	-1	0	-1	-2	-3
7	40	0	0	-1	-2	0	-1	0	-1	-2	-3
8	41	0	0	-1	-2	0	-1	-1	-1	-2	-3
9	42	0	0	-1	-2	0	-1	-2	-1	-2	-3
10	43	-1	0	-1	-2	0	-1	-2	-1	-2	-3
11	44	-1	0	-1	-2	0	-2	-2	-1	-2	-3
12	45	-1	0	-1	-3	-1	-2	-3	-1	-2	-3
13	49	-1	+1	-1	-4	-1	-2	-3	-1	-2	-3
14	37 (-1; -2)	Verblechte Türe (1490 x 3039 mm) 2 x 3 mm Stahlblech und 54 mm Janroc Porte tôlée (1490 x 3039 mm) 2 x 3 mm tôle en acier et 54 mm Janroc Sheet metal clad door (1490 x 3039 mm) 2 x 3 mm sheet metal and 54 mm Janroc									

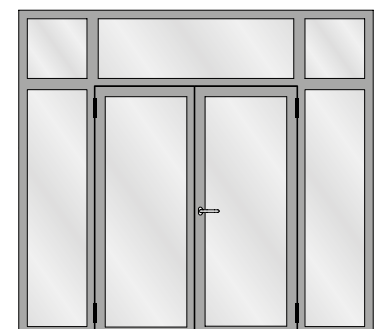
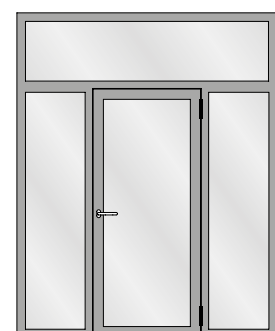
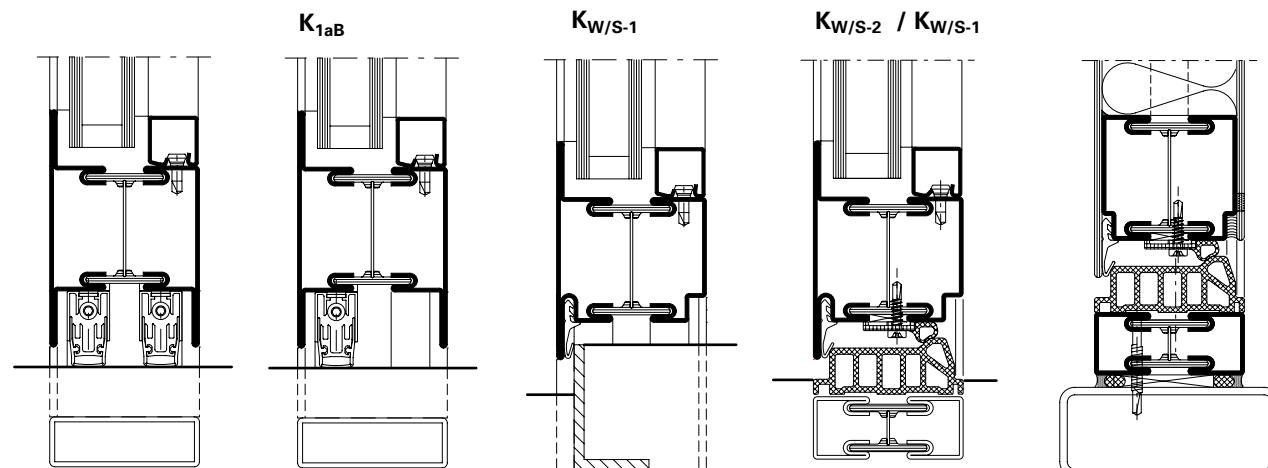

Der aus der Tabelle A1 abzulesende Wert für die Schalldämmung $R_{W, Tür}$ beträgt:

La valeur à relever sur le tableau A1 concernant l'isolement contre les sons aériens $R_{W, Porte}$ est la suivante:

The value taken from table A1 for the sound insulation $R_{W, Door}$ is:

$$R_{W, Tür} = R_W + K_S + K_{FV} + K_{Nass} + K_{1aB} + K_{AW-S} + K_{G 0,4} + K_{G 1,8} + K_{G 2,6} + K_{G 3,2}$$

K_S	Korrekturwert für zweiflügelige Türen	K_S	Valeur de correction pour portes à deux vantaux	K_S	Correction value for double-leaf doors
K_{FV}	Korrekturwert für Festverglasungen mit erhöhtem Scheibenanteil	K_{FV}	Valeur de correction pour vitrages fixes à fort pourcentage de vitre	K_{FV}	Correction value for fixed glazing with increased proportion of pane
K_{Nass}	Korrekturwert für Nassverglasung	K_{Nass}	Valeur de correction pour vitrage avec mastic	K_{Nass}	Correction value for glazing with sealing
K_{1aB}	Korrekturwert für Türen mit einer absenkbaren Bodendichtung	K_{1aB}	Valeur de correction pour portes avec un joint seuil automatique	K_{1aB}	Correction value for doors with a threshold gasket that can be lowered
$K_{W/S-1}$	Korrekturwert für einflügelige Türen mit einem Anschlagwinkel oder einer Anschlagsschwelle	$K_{W/S-1}$	Valeur de correction pour portes à un vantail avec une équerre de butée ou un seuil de butée	$K_{W/S-1}$	Correction value for single-leaf doors with an angle bracket or a rebate threshold
$K_{W/S-2}$	Korrekturwert für zweiflügelige Türen mit einer Anschlagsschwelle	$K_{W/S-2}$	Valeur de correction pour portes à deux vantaux avec un seuil de butée	$K_{W/S-2}$	Correction value for double-leaf doors with a rebate threshold
$K_{G 0,4}$	Korrekturwert für Einzelscheiben mit einer Glasfläche $\leq 0,4 \text{ m}^2$. Die Korrektur gilt auch für Konstruktionen mit glasteilenden Sprossen.	$K_{G 0,4}$	Valeur de correction pour vitres individuelles avec une surface vitrée $\leq 0,4 \text{ m}^2$. La correction s'applique aussi aux constructions à meneaux séparant les vitres.	$K_{G 0,4}$	Correction value for single panes with a glass area $\leq 0,4 \text{ m}^2$. The correction also applies to buildings with glazing bars
$K_{G 1,8}$	Korrekturwert für Einzelscheiben mit einer Glasfläche $\geq 1,8 \text{ m}^2$	$K_{G 1,8}$	Valeur de correction pour vitres individuelles avec surface vitrée $\geq 1,8 \text{ m}^2$	$K_{G 1,8}$	Correction value for single panes with a glass area $\geq 1,8 \text{ m}^2$
$K_{G 2,6}$	Korrekturwert für Einzelscheiben mit einer Glasfläche $\geq 2,6 \text{ m}^2$	$K_{G 2,6}$	Valeur de correction pour vitres individuelles avec surface vitrée $\geq 2,6 \text{ m}^2$	$K_{G 2,6}$	Correction value for single panes with a glass area $\geq 2,6 \text{ m}^2$
$K_{G 3,2}$	Korrekturwert für Einzelscheiben mit einer Glasfläche $\geq 3,2 \text{ m}^2$	$K_{G 3,2}$	Valeur de correction pour vitres individuelles avec surface vitrée $\geq 3,2 \text{ m}^2$	$K_{G 3,2}$	Correction value for single panes with a glass area $\geq 3,2 \text{ m}^2$
R_W	bewertetes Schalldämm-Mass der Türe in Abhängigkeit von der Schalldämmung $R_{W,P, Glas}$	R_W	Mesure d'isolement contre les sons aériens des portes évaluée suivant l'isolement phonique $R_{W,P, vitrage}$	R_W	Airborne sound reduction index of doors depending on the sound insulation $R_{W,P, glazing}$
$R_{W,P, Glas}$	bewertetes Schalldämm-Mass (Prüfwert) der Isolierverglasung. Die Werte müssen über eine Prüfung nach ISO 140-3 an einem Prüfmuster im Format 1230 x 1480 mm ermittelt und durch einen Prüfbericht einer anerkannten Prüfstelle nachgewiesen werden. Alternativ können generische Daten nach DIN EN 12758 verwendet werden.	$R_{W,P, vitrage}$	Mesure d'isolement contre les sons aériens (valeur d'essai) du vitrage isolant évaluée. Les valeurs doivent être déterminées par un essai suivant ISO 140-3 sur un spécimen de format 1230 x 1480 mm et attestées par le procès-verbal d'un bureau de vérification homologué. Alternativement, il est possible d'utiliser des données génériques suivant DIN EN 12758.	$R_{W,P, glazing}$	Airborne sound reduction index (test value) of insulating glazing. The values must be calculated using a test conducted in accordance with ISO 140-3 for a specimen with the dimensions 1230 x 1480 mm and confirmed by a test report of a recognised test centre. Alternatively, generic data can be used in accordance with DIN EN 12758.

